

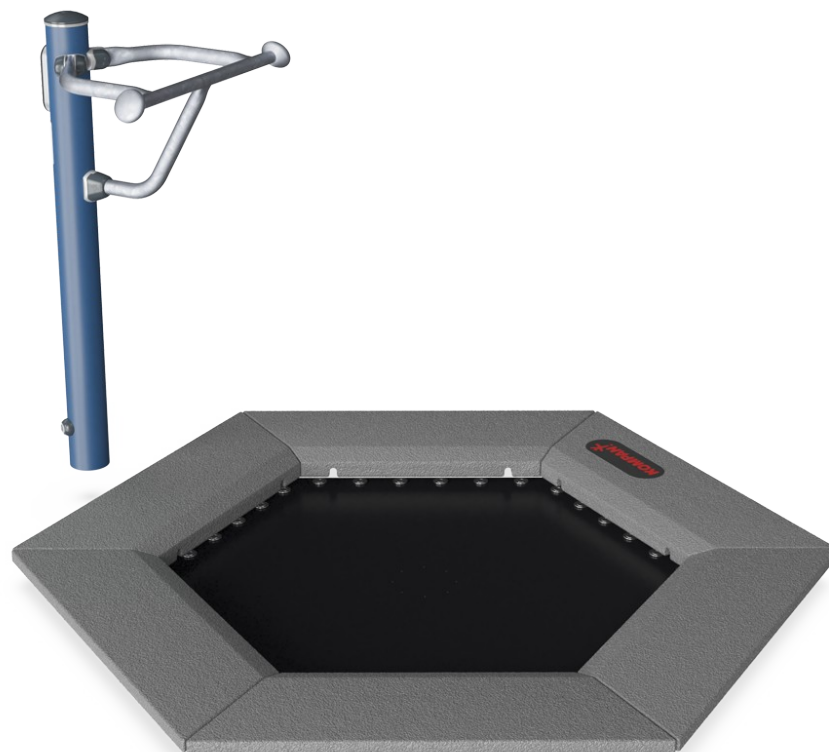

# Fitness Jumper

FSW232



Item no. FSW23200-0902	
<b>General Product Information</b>	
Dimensions LxWxH	192x188x117 cm
Age group	13+
Play capacity (users)	1
Color options	



See KOMPAN Fit app for more



Over the past 10 years, jumping fitness has become increasingly popular. And the reason for this is quite simple. It is tremendous fun, quickly builds up sweat and gives the body a good workout. Jumping on a bouncing element and using our imagination to do different jumps is mentally liberating and something we all can do. The fun keeps us motivated and

entertained and positively drives us to being active for longer time slots. The handlebars offer support for beginners and adds the possibility to do high intensity power rounds with extra high jumps.

# Fitness Jumper

FSW232

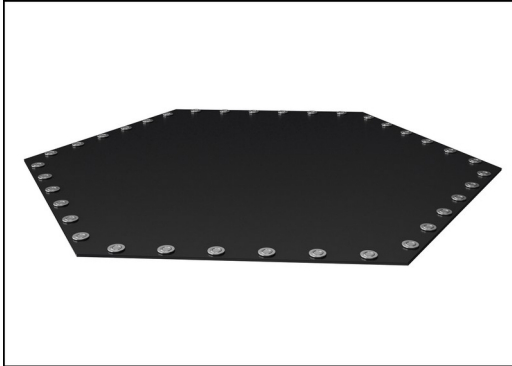

The jumping membranes are made of 6,0mm thick EP Ethylene-Propylene conveyor belt with polyester polyamide fabric carcass. Spring fixations are reinforced with steel bushings and washers on both sides. The membrane is ozone resistant and equipped with 8 center placed water drain holes.



All 36 springs are made of stainless steel to ensure durability and excellent corrosion resistance. The steel wire is 3,2 mm thick and the last five windings are cone shaped to ensure long lifetime of the jumper.

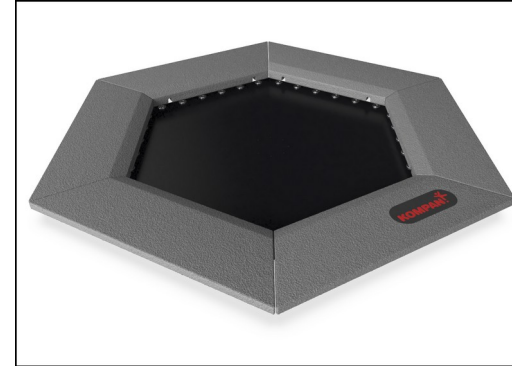

The tiles are molded in grey granulated recycled rubber (SBR/NR), and the KOMPAN logo is made of EPDM Ethylene Propylene Diene Monomer. Inside each of the rubber tiles there is a 3 mm hot dip galvanized steel plate.

Item no. FSW23200-0902

## Installation Information

Max. fall height	100 cm
Safety surfacing area	13.3 m <sup>2</sup>
Total installation time	4.6
Excavation volume	1.15 m <sup>3</sup>
Concrete volume	1.02 m <sup>3</sup>
Footing depth (standard)	90 cm
Shipment weight	383 kg
Anchoring options	

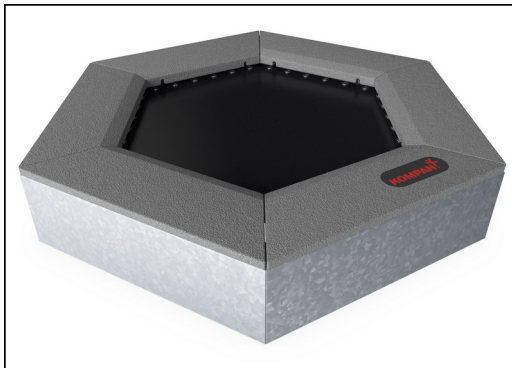

All steel components are manufactured from carbon steel S235 in a thickness of 3 mm. Side panels, support walls for top frame, plates bended with SBR and plates flat for in-situ surfacing are hot dip galvanized.

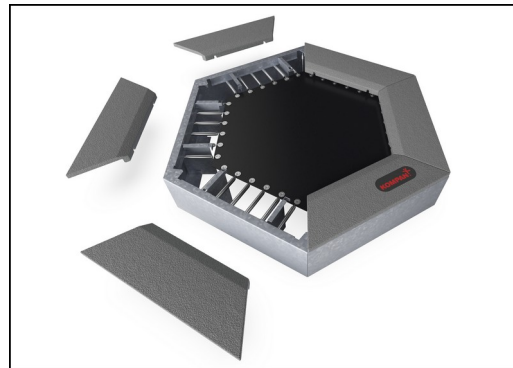

As a unique feature the SBR tiles can be removed for cleaning and service. By loosen six screws the SBR tile can be lifted up to open and gain access to the springs (see instruction on KOMPAN Master).



The support handle is 530mm wide. The handle is 1050mm above ground level, and 1140mm above the jumper membrane. The handle is made from an Ø32mm HDG bar.



# Sustainability Data

FSW232

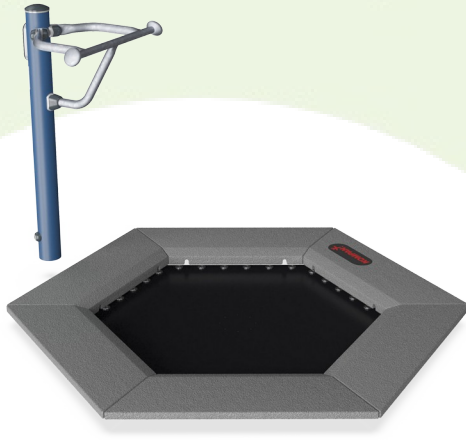

Cradle to Gate A1-A3	Total CO <sub>2</sub> emission	CO <sub>2</sub> e/kg	Recycled materials
	kg CO <sub>2</sub> e	kg CO <sub>2</sub> e/kg	%
<b>FSW23200-0902</b>	439.50	2.19	59.10

The overall framework applied for these factors is the Environmental Product Declaration (EPD), which quantifies "environmental information on the life cycle of a product and enable comparisons between products fulfilling the same function" (ISO, 2006). This follows the structure and applies a Life-Cycle Assessment approach to the entire Product stage from raw material through manufacturing (A1-A3))

**Kompan A/S**  
C.F. Tietgens Boulevard 32C  
DK-5220 Odense SØ  
Denmark



## Verification of CO<sub>2</sub> calculation of: Fitness



Data version no. 2023-10-05

The CO<sub>2</sub> calculation and data are in compliance with the principles of a carbon footprint impact according to the GHG protocol (Greenhouse Gas Protocol), Scope 3, cradle to gate related to all individual components in the product category: "Fitness" represented by item no.: FAZ10100-0900.

(Scope 3 emissions include emission sources in the upstream and downstream value chain).

**Date: 30. October 2023 | Valid until: 30. October 2025**

Verified by:

Julie Marie Vejsgaard Larsen, LCA & EPD Consultant

Verification based on report: Validation of CO<sub>2</sub> calculation of 9 categories of Kompan product line, version 1.0, prepared by: Bureau Veritas HSE, Denmark: Julie M. V. Larsen.

**Publication date: 30. October 2023**

By Bureau Veritas HSE  
www.bureauveritas.dk  
+45 7731 1000



# Fitness Jumper

FSW232

\* Max fall height | \*\* Total height | \*\*\* Safety surfacing area

\* Max fall height | \*\* Total height

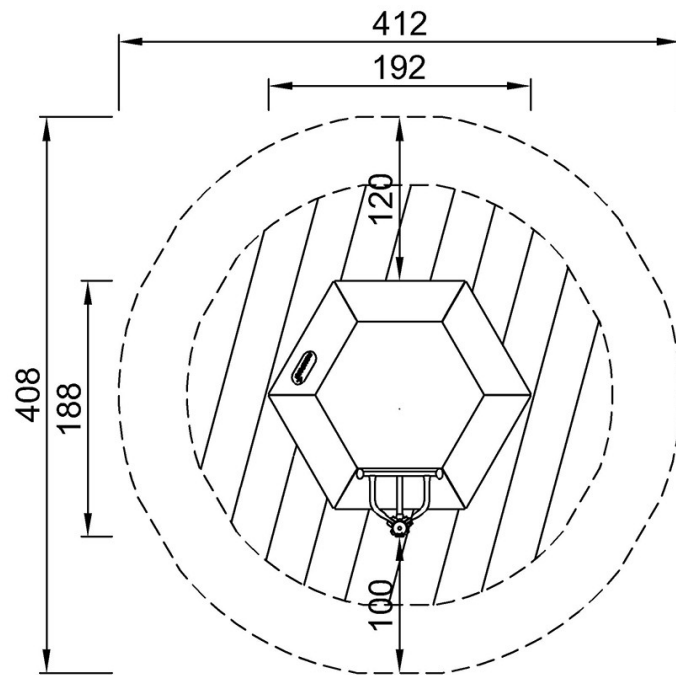

FSW23200  
\*100cm  
\*\*117cm  
\*\*\*13.3m<sup>2</sup>

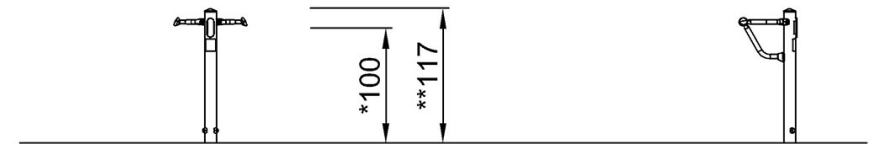

FSW23200

[Click to see TOP VIEW](#)

[Click to see SIDE VIEW](#)