

Four Tower with Wobbly Bridge

KPL4005

KOMPAN
Let's play



Item no. KPL400511-0601

General Product Information

Dimensions LxWxH	441x229x214 cm
Age group	1+
Play capacity (users)	18
Color options	

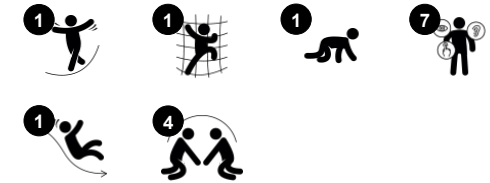

The Four Tower with Two Bridges offers a wealth of diverse climbing, crawling and sliding experiences. The diversity in play experiences make children come back again and again. The different bridges offer each their muscle and motor skill stimulating play event: the step bridge offers graded access, each platform offering a point for a break or a meeting. The

tunnel takes sliding or crawling through, both great for the cross-body coordination. This trains the cooperation between the left and right brain half which is necessary for later reading skills. The slide stimulates the spatial awareness, needed for navigating space, e.g. in traffic, securely. The inclined bridge with skid preventive floor details support less physically

confident users. This is the obvious play activity for e.g. children with physical disabilities, with a perfect distance of access point on ground level to egress point.



Four Tower with Wobbly Bridge

KPL4005



Tunnel

Physical: the children crawl through the tunnel, developing motor skills such as cross-body coordination and proprioception. **Social-Emotional:** turn-taking when passing each other.



Slide

Physical: sliding develops spatial awareness and a sense of balance. Furthermore, the core muscles are trained when sitting upright going down. **Social-Emotional:** empathy stimulated by turn-taking. **Cognitive:** young children develop their understanding of space, speed and distances when sliding down quickly.

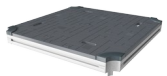

Platform

Social-Emotional: Important life skills like courage, self-confidence, consideration and turn-taking are built.



Trekking bridge

Physical: the wobbly bridge trains balance and coordination as well as spatial awareness: when children cross the bridge by running or jumping. **Social-Emotional:** turn-taking and consideration when passing each other. Cooperation and socializing with others in and around the bridge.



Climb bridge

Physical: the skid-preventive cross-bars function as support for toddlers going up and down, supporting spatial awareness.

Four Tower with Wobbly Bridge

KPL4005



Panels of 19mm EcoCore™. EcoCore™ is a highly durable, eco friendly material, which is not only recyclable after use, but also consists of material produced from +95% recycled post consumer material from food packing waste.



The main tower posts are available in two types of material: European pine wood posts, pressure impregnated Class 3 with Tanalith E3475 according to EN335 (Equivalent to NTR Class AB). Aluminum post t=2mm with anodized surface treatment. Base material EN AW-6060 T66.



Floors and panel activities are available in two types of material: Waterproof plywood decks thickness 21.5mm from pine and alder wood with anti-slip film on both sides. High Pressure Laminate HPL thickness 17.8mm with slip resistant surface texture according to EN 438-6.

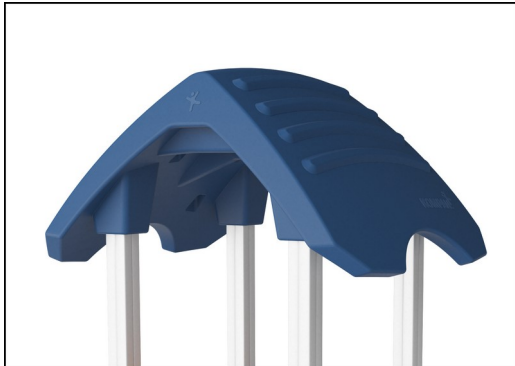

The large hollow components are made of 100% recyclable PE. The roof displayed is moulded in one piece with minimum 5,5mm wall thickness to ensure high durability in all climates around the world.

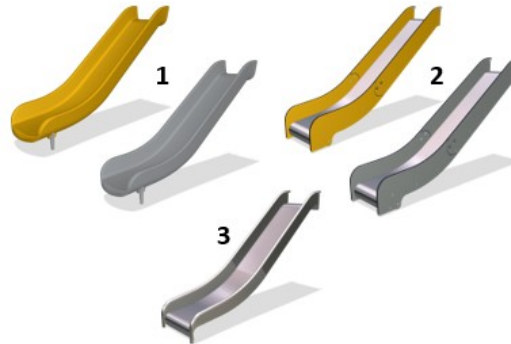

Slides are available in three different materials: moulded on piece PE slides made from 33% post-consumer materials, Combined EcoCore™ sides and stainless steel slide bed t=2mm. Full stainless steel AISI304 t=2mm.

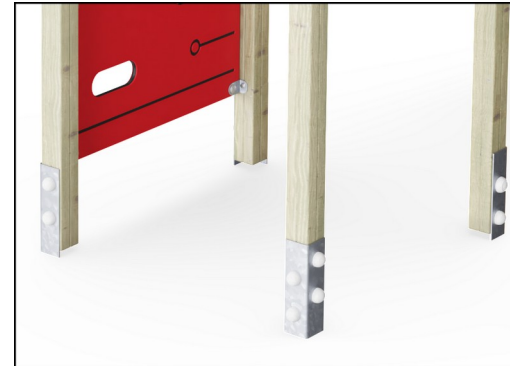

The main posts are equipped with hot dip galvanised steel footings. The steel footings elevates the posts 20mm from ground level to avoid contact with surfacing material.

Item no. KPL400511-0601

Installation Information

Max. fall height	100 cm
Safety surfacing area	29.5 m ²
Total installation time	17.3
Excavation volume	0.97 m ³
Concrete volume	0.00 m ³
Footing depth (standard)	60 cm
Shipment weight	464 kg
Anchoring options	In-ground <input checked="" type="checkbox"/> Surface <input checked="" type="checkbox"/>

Warranty Information

Aluminum	15 years
EcoCore HDPE	Lifetime
Hollow PE parts	10 years
Pinewood	10 years
Spare parts guaranteed	10 years



Sustainability Data

KPL4005



Cradle to Gate A1-A3	Total CO ₂ emission	CO ₂ e/kg	Recycled materials
	kg CO ₂ e	kg CO ₂ e/kg	%
KPL400511-0601	505.33	1.42	33.10

The overall framework applied for these factors is the Environmental Product Declaration (EPD), which quantifies "environmental information on the life cycle of a product and enable comparisons between products fulfilling the same function" (ISO, 2006). This follows the structure and applies a Life-Cycle Assessment approach to the entire Product stage from raw material through manufacturing (A1-A3))

Kompan A/S
 C.F. Tietgens Boulevard 32C
 DK-5220 Odense SØ
 Denmark



Verification of CO₂ calculation of: Play systems



Data version no. 2023-10-05

The CO₂ calculation and data are in compliance with the principles of a carbon footprint impact according to the GHG protocol (Greenhouse Gas Protocol), Scope 3, cradle to gate related to all individual components in the product category: "Play systems" represented by item no.: PCM200321-0950.

(Scope 3 emissions include emission sources in the upstream and downstream value chain).

Date: 30. October 2023 | Valid until: 30. October 2025

Verified by:

Julie Marie Vejsgaard Larsen, LCA & EPD Consultant

Verification based on report: Validation of CO₂ calculation of 9 categories of Kompan product line, version 1.0, prepared by: Bureau Veritas HSE, Denmark: Julie M. V. Larsen.

Publication date: 30. October 2023

By Bureau Veritas HSE
 www.bureauveritas.dk
 +45 7731 1000



Four Tower with Wobbly Bridge

KPL4005

* Max fall height | ** Total height | *** Safety surfacing area

* Max fall height | ** Total height

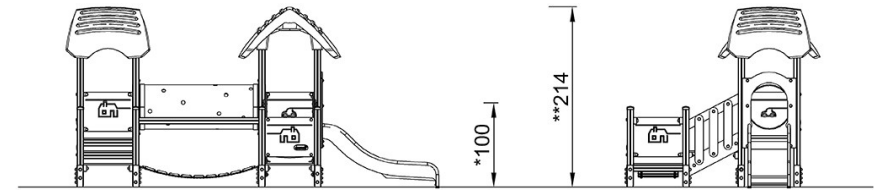
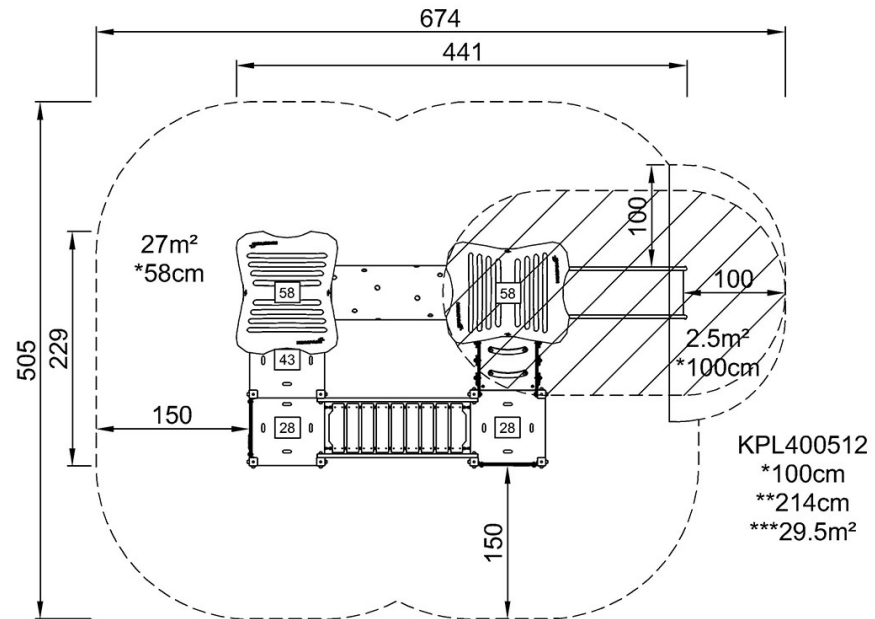

[Click to see TOP VIEW](#)

[Click to see SIDE VIEW](#)