

Climber

M870

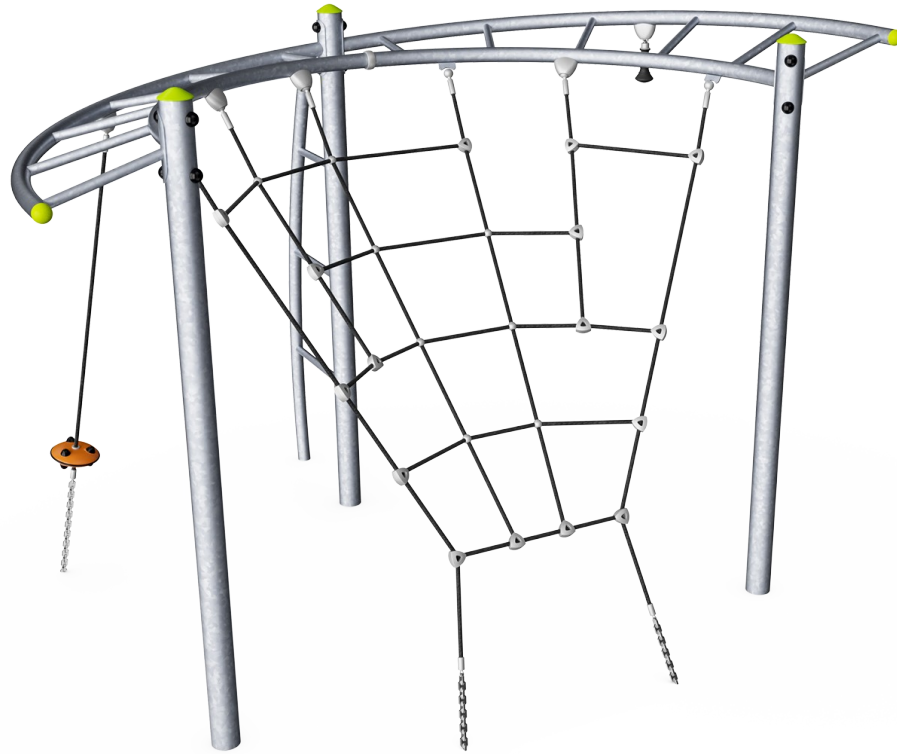

Item no. M87001-3417

General Product Information

Dimensions LxWxH	323x268x228 cm
Age group	4+
Play capacity (users)	8
Color options	●

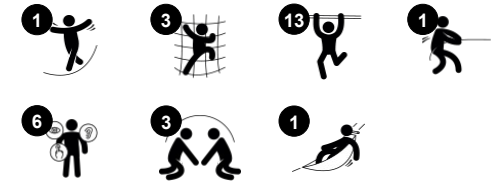

The Climb play structure is a robust climber offering a wide variety of climbing options; up, down, across. The structure supports many body positions and play possibilities with its design detail and diverse levels of difficulty. Children will feel motivated to climb the diverse paths up and enjoy the view again and again. Due to the spread out and the transparent

design, the Climb has a high play capacity. The overhead bars, ladder and climbing net train muscle strength, agility and coordination. The overhead ladder is a nice meeting point but also motivates travelling across using the arms, training the upper body muscles. These are known to be weaker in today's children due to increased sedentary behaviours. The inclined

net makes for an easier climb up, together with friends. It can be climbed on both sides for variation. The rope with the UFO is the most challenging and helps muscle training.



Climber

M870



Overhead ladder

Physical: develops children's upper body muscles and arm strength, cross coordination and spatial awareness. This is especially important due to sedentary lifestyles and back-pain in children. **Social-Emotional:** chill and socialize on top of the overhead ladder, training cooperation.

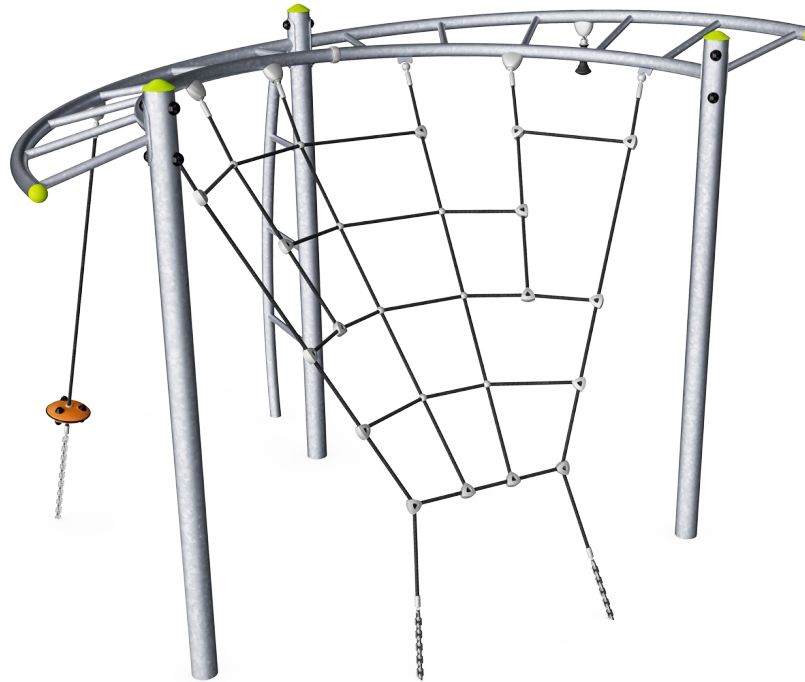

Climbing net

Physical: the inclined net supports the upward climbing movement of the body. Children develop cross-body coordination and muscle strength. The asymmetry of the net challenges the children's climbing. **Social-Emotional:** the big meshes allow for more children seated together, sharing.



Ufo

Physical: sense of balance when sitting, swaying. Arm and leg muscles develop when holding tight, climbing up.



Pipe ladder

Physical: cross coordination and eye-hand coordination are supported when children climb the ladder. The climbing also supports leg and arm muscles. **Social-Emotional:** learning about turn taking and cooperation.

Climber

M870



The steel surfaces are hot dip galvanised inside and outside with lead free zinc. The galvanisation has excellent corrosion resistance in outside environments and requires low maintenance.

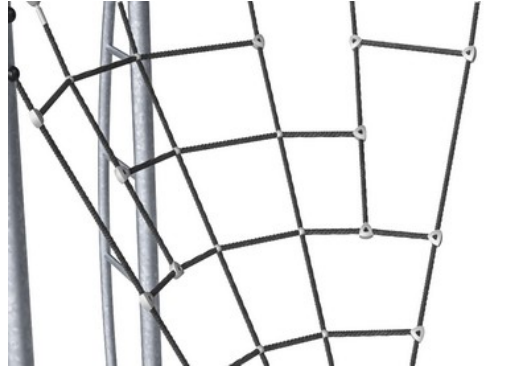

Climbing nets are made of UV-stabilised PA rope with inner steel cable reinforcement. The rope is induction treated to obtain maximum fixation between steel and rope which provides excellent wear and tear resistance. All rope connectors are made of 100% recyclable PA material.



Play activities like UFO are made of injection moulded high quality UV-stabilised nylon (PA6). Nylon has good wearing and impact strength.

Item no. M87001-3417

Installation Information

Max. fall height	227 cm
Safety surfacing area	32.8 m ²
Total installation time	6.6
Excavation volume	2.60 m ³
Concrete volume	0.36 m ³
Footing depth (standard)	80 cm
Shipment weight	291 kg
Anchoring options	In-ground ✓ Surface ✓



Sustainability Data

M870

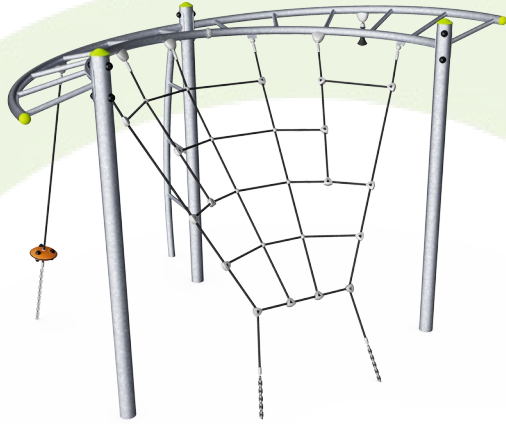

Cradle to Gate A1-A3	Total CO ₂ emission	CO ₂ e/kg	Recycled materials
	kg CO ₂ e	kg CO ₂ e/kg	%
M87001-3417	491.13	1.71	25.27

The overall framework applied for these factors is the Environmental Product Declaration (EPD), which quantifies "environmental information on the life cycle of a product and enable comparisons between products fulfilling the same function" (ISO, 2006). This follows the structure and applies a Life-Cycle Assessment approach to the entire Product stage from raw material through manufacturing (A1-A3))

Kompan A/S
 C.F. Tietgens Boulevard 32C
 DK-5220 Odense SØ
 Denmark



Verification of CO₂ calculation of: Freestanding play equipment



Data version no. 2023-10-05

The CO₂ calculation and data are in compliance with the principles of a carbon footprint impact according to the GHG protocol (Greenhouse Gas Protocol), Scope 3, cradle to gate related to all individual components in the product category: "Freestanding play equipment" represented by item no.: GXY916012-3417.

(Scope 3 emissions include emission sources in the upstream and downstream value chain).

Date: 30. October 2023 | Valid until: 30. October 2025

Verified by:

Julie Marie Vejsgaard Larsen, LCA & EPD Consultant

Verification based on report: Validation of CO₂ calculation of 9 categories of Kompan product line, version 1.0, prepared by: Bureau Veritas HSE, Denmark: Julie M. V. Larsen.

Publication date: 30. October 2023

By Bureau Veritas HSE
 www.bureauveritas.dk
 +45 7731 1000



Climber

M870

* Max fall height | ** Total height | *** Safety surfacing area

* Max fall height | ** Total height

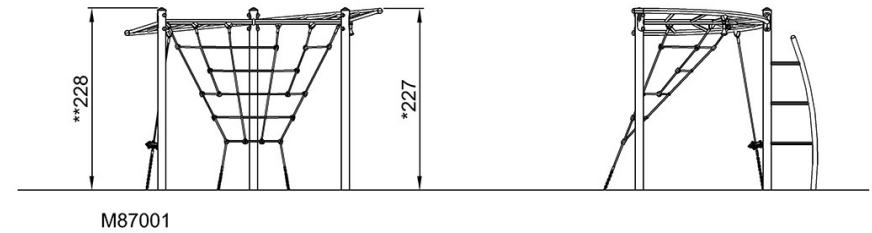
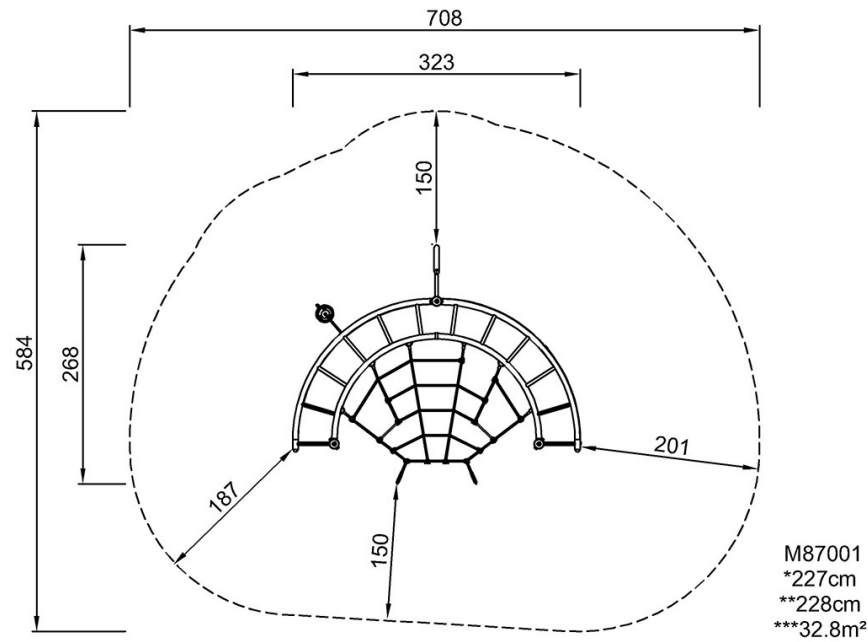

[Click to see TOP VIEW](#)

[Click to see SIDE VIEW](#)