

# Two Tower with Wackle

PCM211721

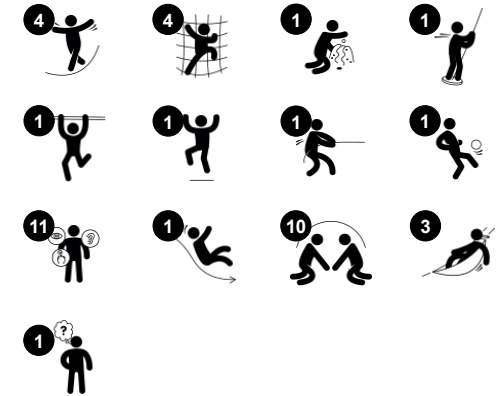

Item no. PCM211721-0951	
General Product Information	
Dimensions LxWxH	860x341x412 cm
Age group	4+
Play capacity (users)	23
Color options	



WOW! The amount of play value in the Double Tower and wobbly bridge appeals strongly to play again and again. The graded play events offer rich physical and social play opportunities. The wobbly bridge is an exciting challenge where children can balance and mildly sway their way over. This trains the senses of balance and space, which are fundamental in

confidently and securely mastering the body in the world. The wild banister bars are so much fun, and they build up an understanding of speed and distances that will be helpful in street traffic. Under the platforms, nice benches and a swaying hammock offer great meeting points. The timer panel additionally adds a possibility to cooperate and take turns. All in all,

a great climb, balance, slide, glide and meeting play unit.

# Two Tower with Wackle

PCM211721



## Wackle bridge

**Physical:** sense of balance and space, and training of posture. Important for being able to sit still. **Social-Emotional:** cooperation, turn-taking and friendly competition on the plates.

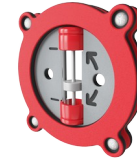

## Timer

**Social-Emotional:** teams can each have a button to measure rounds, wins etc. The buttons support cooperation and teamwork. **Cognitive:** counting and registering support thinking skills such as logical thinking and sequencing. **Creative:** children can leave their mark, placing the timer in different positions.



## Banister bars

**Physical:** coordination is supported when going down, as well as arm and core muscles. Landing strengthens bone density, which is built for life in childhood. **Social-Emotional:** turn-taking and risk-taking.



## Tower net

**Physical:** the children have fast access up the horizontal rungs, and a slower climb up the sloping rungs. The net can be climbed from both sides, levelling the challenge. Cross coordination, and arm and leg muscles are trained. **Social-Emotional:** the two-sided net and spaciousness allows for social interaction. **Cognitive:** logical thinking when planning how to best enter the platform from the net.



## Hammock

**Physical:** coordination and sense of balance when swaying. **Social-Emotional:** meeting, pushing friends gently back and forth, turn-taking. **Cognitive:** for toddlers cause and effect understanding.

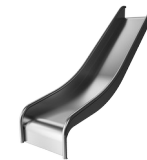

## Slide

**Physical:** sliding develops spatial awareness and a sense of balance. Furthermore, the core muscles are trained when sitting upright going down. **Social-Emotional:** empathy stimulated by turn-taking.



## Rapella

**Physical:** supports cross coordination, proprioception and sense of space. Leg and core muscles are used intensely. Upper body muscles are developed when children pull themselves upwards in the rope. **Social-Emotional:** turn-taking and self-regulation, both important life skills.

# Two Tower with Wackle

PCM211721

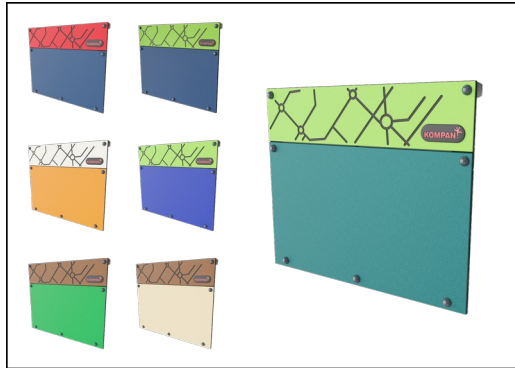

Panels of 19mm EcoCore™. EcoCore™ is a highly durable, eco friendly material, which is not only recyclable after use, but also consists of material produced from +95% recycled post consumer material from food packing waste.



All decks are supported by unique designed low-carbon aluminum profiles with multiple attachment options. The grey colored molded decks are made of 75% post-consumer waste PP material with a non-skid pattern and texture surface.



Main posts with hot dip galvanized steel footing are available in different materials: Pressure impregnated pine wood posts. Pre-galvanized inside and outside with powder coated top finish steel posts. Lead free aluminum with color anodized top finish. Greenline TexMade posts of 95% post-consumer recycled PE and textile waste.

Item no. PCM211721-0951	
Installation Information	
Max. fall height	276 cm
Safety surfacing area	56.7 m <sup>2</sup>
Total installation time	26.3
Excavation volume	0.87 m <sup>3</sup>
Concrete volume	0.24 m <sup>3</sup>
Footing depth (standard)	90 cm
Shipment weight	1,127 kg
Anchoring options	Surface ✓ In-ground ✓
Warranty Information	
EcoCore HDPE	Lifetime
Post	10 years
PP Decks	10 years
Ropes & nets	10 years
Spare parts guaranteed	10 years

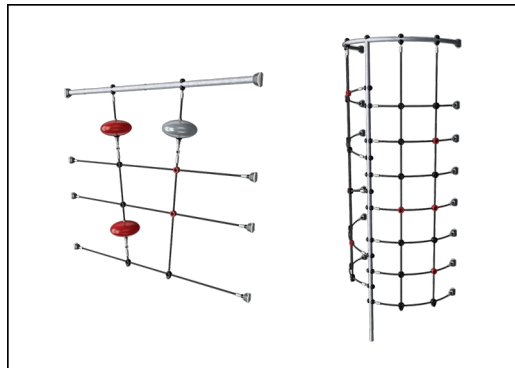

Ropes are made of UV-stabilised PA with inner steel cable reinforcement. The rope is induction treated in order to create a strong connection between steel and rope which leads to good wear resistance.



The slides can be chosen in six different colors and three materials: Straight or curved one-piece molded PE slides, made from 33% recycled post-consumer materials in different colours. Combined EcoCore™ sides and stainless-steel. Full stainless steel in one piece design for more vandalism proof solutions.



KOMPAN GreenLine versions are designed with ultimate environmentally friendly materials with lowest possible CO2e emission factor. TexMade post, EcoCore™ panels of 95% post-consumer recycled waste and molded PP decks.



# Sustainability Data

PCM211721



Cradle to Gate A1-A3	Total CO <sub>2</sub> emission	CO <sub>2</sub> e/kg	Recycled materials
	kg CO <sub>2</sub> e	kg CO <sub>2</sub> e/kg	%
<b>PCM211721-0951</b>	1,221.34	1.57	72.35
<b>PCM211721-0905</b>	1,364.02	2.15	61.52

The overall framework applied for these factors is the Environmental Product Declaration (EPD), which quantifies "environmental information on the life cycle of a product and enable comparisons between products fulfilling the same function" (ISO, 2006). This follows the structure and applies a Life-Cycle Assessment approach to the entire Product stage from raw material through manufacturing (A1-A3))

**Kompan A/S**  
C.F. Tietgens Boulevard 32C  
DK-5220 Odense SØ  
Denmark



## Verification of CO<sub>2</sub> calculation of: Play systems



Data version no. 2023-10-05

The CO<sub>2</sub> calculation and data are in compliance with the principles of a carbon footprint impact according to the GHG protocol (Greenhouse Gas Protocol), Scope 3, cradle to gate related to all individual components in the product category: "Play systems" represented by item no.: PCM200321-0950.

(Scope 3 emissions include emission sources in the upstream and downstream value chain).

**Date: 30. October 2023 | Valid until: 30. October 2025**

Verified by:

Julie Marie Vejsgaard Larsen, LCA & EPD Consultant

Verification based on report: Validation of CO<sub>2</sub> calculation of 9 categories of Kompan product line, version 1.0, prepared by: Bureau Veritas HSE, Denmark: Julie M. V. Larsen.

**Publication date: 30. October 2023**

By Bureau Veritas HSE  
www.bureauveritas.dk  
+45 7731 1000



# Two Tower with Wackle

PCM211721

\* Max fall height | \*\* Total height | \*\*\* Safety surfacing area

\* Max fall height | \*\* Total height

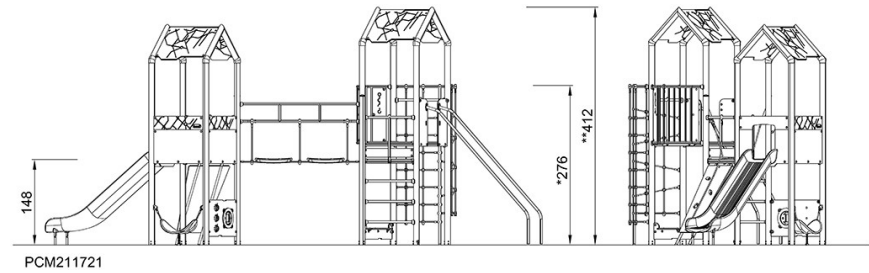
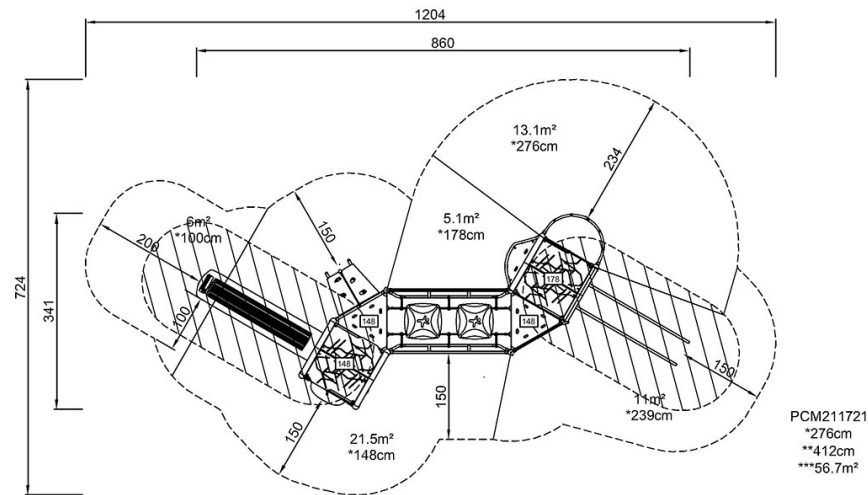

[Click to see TOP VIEW](#)

[Click to see SIDE VIEW](#)