

# Triple Play Tower

PCM311321

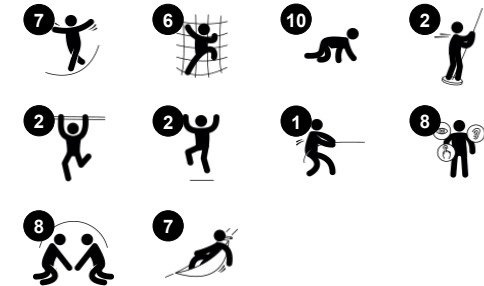

Item no. PCM311321-0905	
General Product Information	
Dimensions LxWxH	487x460x380 cm
Age group	4+
Play capacity (users)	17
Color options	



The amount of play value in the Triple Play Tower will inspire play again and again. The challenging play events centre around balancing, cross-coordination and thrilling gliding. Climbing helps train the children's upper-body muscles and cross-coordination. This is fundamental to navigate the world confidently and safely. The senses of balance

and space are tested on the level-spanning balance bridge and on the fun banister bars. On the other tower, a dare-devil fireman's pole brings children to the ground in a whizz. The big climbing net has meshes that allow for climbing through, yet another cross-coordination movement. The rungs are wide enough for children to have a seat and meet

and exchange. Pure fun and great training experiences in one play item.

# Triple Play Tower

PCM311321



## Pipe ladder

**Physical:** cross coordination and eye-hand coordination are supported when children climb the ladder. The climbing also supports leg and arm muscles. **Social-Emotional:** learning about turn taking and cooperation.

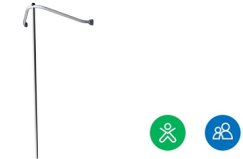

## Fireman's pole

**Physical:** coordination is supported when going down, as well as arm and core muscles. Landing strengthens bone density, which is built for life in early childhood. **Social-Emotional:** turn-taking and risk-taking.

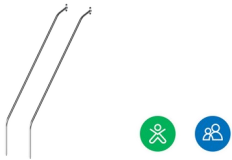

## Banister bars

**Physical:** coordination is supported when going down, as well as arm and core muscles. Landing strengthens bone density, which is built for life in childhood. **Social-Emotional:** turn-taking and risk-taking.



## Sway alley

**Physical:** passing the swaying bridge steps develops the sense of balance, which is fundamental in navigating the world securely. **Social-Emotional:** passing others on the way supports consideration and turn-taking skills.



## Rapella

**Physical:** supports cross coordination, proprioception and sense of space. Leg and core muscles are used intensely. Upper body muscles are developed when children pull themselves upwards in the rope. **Social-Emotional:** turn-taking and self-regulation, both important life skills.

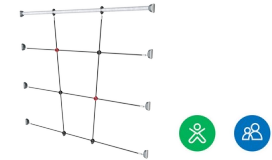

## Climbing net

**Physical:** children develop cross-body coordination and muscle strength when climbing. The big meshes allow for climbing and crawling through, supporting proprioception and spatial awareness. **Social-Emotional:** the big meshes allow for more children to sit together and talk.

# Triple Play Tower

PCM311321



Panels of 19mm EcoCore™. EcoCore™ is a highly durable, eco friendly material, which is not only recyclable after use, but also consists of material produced from +95% recycled post consumer material from food packing waste.



All decks are supported by unique designed low-carbon aluminum profiles with multiple attachment options. The grey colored molded decks are made of 75% post-consumer waste PP material with a non-skid pattern and texture surface.



Main posts with hot dip galvanized steel footing are available in different materials: Pressure impregnated pine wood posts. Pre-galvanized inside and outside with powder coated top finish steel posts. Lead free aluminum with color anodized top finish. Greenline TexMade posts of 95% post-consumer recycled PE and textile waste.

Item no. PCM311321-0905

### Installation Information

Max. fall height	224 cm
Safety surfacing area	48.5 m <sup>2</sup>
Total installation time	20.3
Excavation volume	0.77 m <sup>3</sup>
Concrete volume	0.17 m <sup>3</sup>
Footing depth (standard)	90 cm
Shipment weight	792 kg
Anchoring options	Surface ✓ In-ground ✓

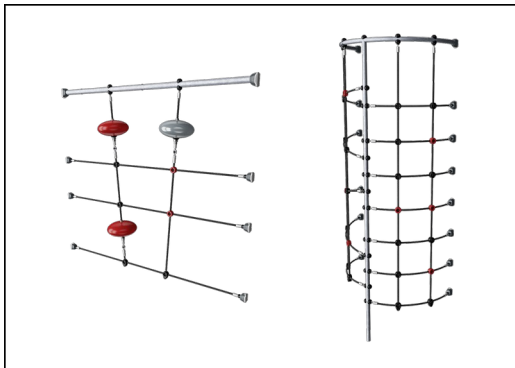

Ropes of UV-stabilized PES rope strands with inner steel cable reinforcement. The polyester yarn is made from +95% post-consumer materials and is inductively melted onto each strand.



The slides can be chosen in six different colors and three materials: Straight or curved one-piece molded PE slides, made from 33% recycled post-consumer materials in different colours. Combined EcoCore™ sides and stainless-steel. Full stainless steel in one piece design for more vandalism proof solutions.



KOMPAN GreenLine versions are designed with ultimate environmentally friendly materials with lowest possible CO2e emission factor. TexMade post, EcoCore™ panels of 95% post-consumer recycled waste and molded PP decks.



# Sustainability Data

PCM311321



Cradle to Gate A1-A3	Total CO <sub>2</sub> emission	CO <sub>2</sub> e/kg	Recycled materials
	kg CO <sub>2</sub> e	kg CO <sub>2</sub> e/kg	%
<b>PCM311321-0951</b>	1,137.99	1.69	73.76
<b>PCM311321-0905</b>	1,521.93	2.77	55.74

The overall framework applied for these factors is the Environmental Product Declaration (EPD), which quantifies "environmental information on the life cycle of a product and enable comparisons between products fulfilling the same function" (ISO, 2006). This follows the structure and applies a Life-Cycle Assessment approach to the entire Product stage from raw material through manufacturing (A1-A3))

**Kompan A/S**  
 C.F. Tietgens Boulevard 32C  
 DK-5220 Odense SØ  
 Denmark



## Verification of CO<sub>2</sub> calculation of: Play systems



Data version no. 2023-10-05

The CO<sub>2</sub> calculation and data are in compliance with the principles of a carbon footprint impact according to the GHG protocol (Greenhouse Gas Protocol), Scope 3, cradle to gate related to all individual components in the product category: "Play systems" represented by item no.: PCM200321-0950.

(Scope 3 emissions include emission sources in the upstream and downstream value chain).

**Date: 30. October 2023 | Valid until: 30. October 2025**

Verified by:

Julie Marie Vejsgaard Larsen, LCA & EPD Consultant

Verification based on report: Validation of CO<sub>2</sub> calculation of 9 categories of Kompan product line, version 1.0, prepared by: Bureau Veritas HSE, Denmark: Julie M. V. Larsen.

**Publication date: 30. October 2023**

By Bureau Veritas HSE  
 www.bureauveritas.dk  
 +45 7731 1000



# Triple Play Tower

PCM311321

\* Max fall height | \*\* Total height | \*\*\* Safety surfacing area

\* Max fall height | \*\* Total height

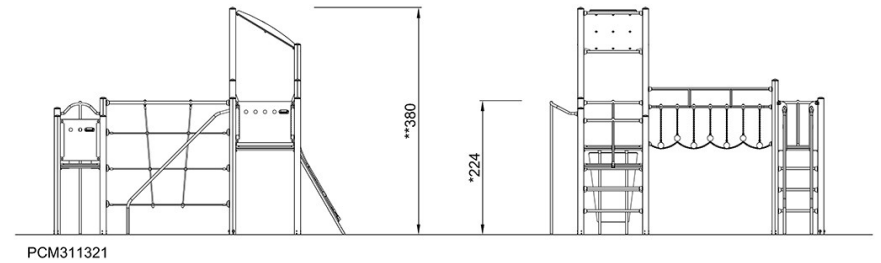
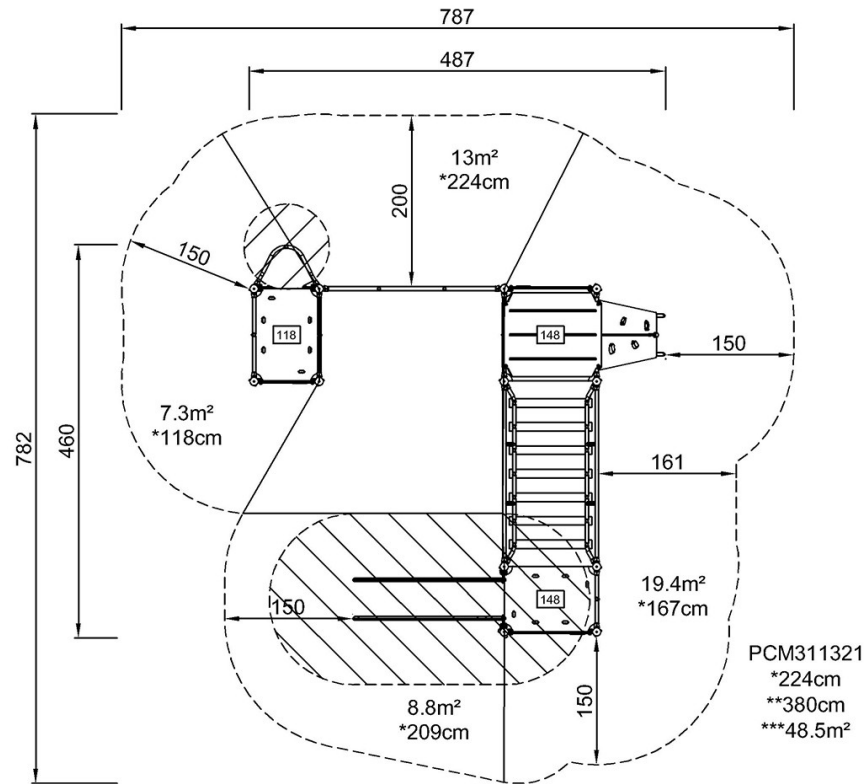

[Click to see TOP VIEW](#)

[Click to see SIDE VIEW](#)