

Achiever

PCE206021



Item no. PCE206021-0903

General Product Information

Dimensions LxWxH	735x530x230 cm
Age group	2+
Play capacity (users)	20
Colour options	

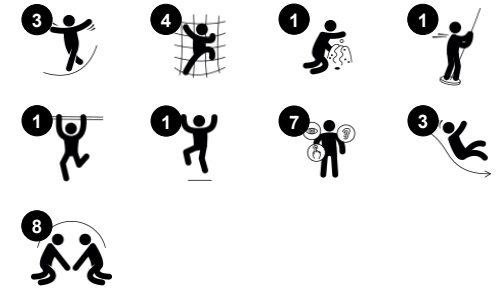

Wow! The Achiever is a fantastic structure, loaded with play. The varied activities support and encourage longer play times. Children can climb in a variety of ways and across different surfaces for an attractive yet challenging play experience. The double slide, curved slides and fireman's pole are rewarding and social ways to return to the ground. The specially

designed balcony supports active imaginative and make-believe play. Apart from climbing and sliding, the Achiever offers plenty of opportunities for social play that will help children build important social and emotional skills, and motivate them to play for longer.

Achiever

PCE206021



Pipe ladder

Physical: cross coordination and eye-hand coordination are supported when children climb the ladder. The climbing also supports leg and arm muscles. **Social-Emotional:** learning about turn taking and cooperation.



Double slide

Physical: develops spatial awareness, sense of balance and trains core muscles when sitting upright going down. **Social-Emotional:** invites socialising, supports parent-child and peer-to-peer play. **Cognitive:** young children train their understanding of space, speed and distances when sliding down.

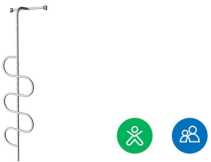

Climbing pole

Physical: cross coordination and muscle strength are trained. **Social-Emotional:** turn-taking and cooperation.

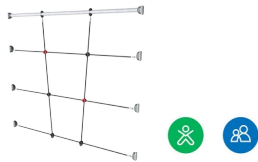

Climbing net

Physical: children develop cross-body coordination and muscle strength when climbing. The big mesh supports proprioception and spatial awareness. **Social-Emotional:** the big meshes allow for more children to sit together and talk.



Megaphone

Social-Emotional: inspires communication and turn-taking skills. **Cognitive:** distortion of sound evokes curiosity and stimulates an understanding of cause and effect.



Fireman's pole

Physical: supports coordination, arm and core muscles. Landing strengthens bone density. **Social-Emotional:** turn-taking and risk-taking. **Cognitive:** young children develop their understanding of space, speed and distances when gliding down fast.

Achiever

PCE206021

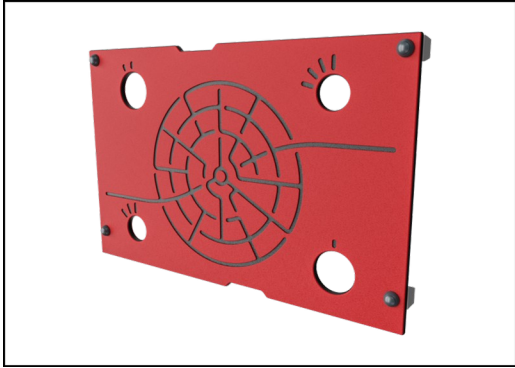

Panels of 19mm EcoCore™. EcoCore™ is a highly durable, eco-friendly material, which is not only recyclable after use but also consists of a core produced from 100% recycled material.



The ELEMENTS roofs are made of recyclable PE with a minimum wall thickness of 5 mm to ensure high durability in all climates around the world. The steel pipes are hot-dip galvanised inside and outside for maximum durability.



Sails of commercial 95 high-density PE knitted specially for sun-shade structures. The sails are treated with UV stabilisers to ensure longevity. The sails are supported by a hot-dip galvanised steel frame and tightened by stainless-steel devices.

Item no. PCE206021-0903

Installation Information

Max. fall height	224 cm
Safety surfacing area	52.9 m ²
Total installation time	20.2
Excavation volume	0.48 m ³
Concrete volume	0.02 m ³
Footing depth (standard)	90 cm
Shipment weight	655 kg
Anchoring options	In-ground ✓ Surface ✓

Warranty Information

EcoCore HDPE	Lifetime
Hollow PE parts	10 years
Post	10 years
PP Decks	10 years
Spare Parts Guarantee	10 years



The main posts are made of high quality pre-galvanized steel with powder coated top finish. Post tops are closed with caps of UV stabilized nylon (PA6). The grey colored molded decks are made of 75% post-consumer ocean waste PP material with a non-skid pattern and textured surface. All decks are supported by uniquely designed, low-carbon aluminum profiles with multiple attachment options.

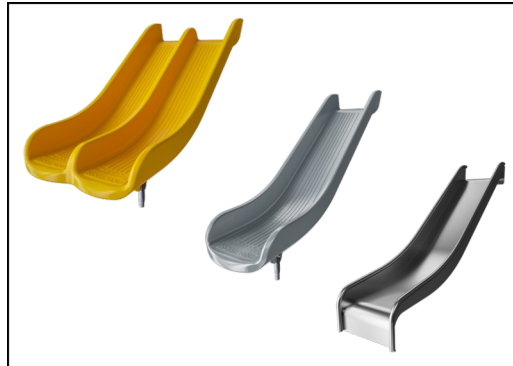

The slides are available in either moulded PE in different colours or in full stainless steel - AISI304 t= 2mm.

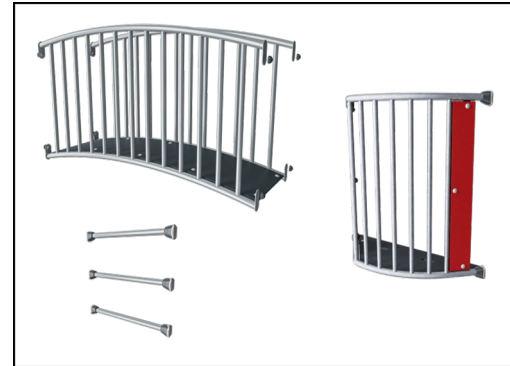

The steel surfaces are hot-dip galvanised inside and outside with lead-free zinc. The galvanisation has excellent corrosion resistance in outside environments and requires low maintenance.



Sustainability Data

PCE206021



Cradle to Gate A1-A3	Total CO ₂ emission	CO ₂ e/kg	Recycled materials
	kg CO ₂ e	kg CO ₂ e/kg	%
PCE206021-0903	1,307.08	2.63	50.26

The overall framework applied for these factors is the Environmental Product Declaration (EPD), which quantifies "environmental information on the life cycle of a product and enable comparisons between products fulfilling the same function" (ISO, 2006). This follows the structure and applies a Life-Cycle Assessment approach to the entire Product stage from raw material through manufacturing (A1-A3))

Kompan A/S
 C.F. Tietgens Boulevard 32C
 DK-5220 Odense SØ
 Denmark



Verification of CO₂ calculation of: Play systems



Data version no. 2023-10-05

The CO₂ calculation and data are in compliance with the principles of a carbon footprint impact according to the GHG protocol (Greenhouse Gas Protocol), Scope 3, cradle to gate related to all individual components in the product category: "Play systems" represented by item no.: PCM200321-0950.

(Scope 3 emissions include emission sources in the upstream and downstream value chain).

Date: 30. October 2023 | Valid until: 30. October 2025

Verified by:

Julie Marie Vejsgaard Larsen, LCA & EPD Consultant

Verification based on report: Validation of CO₂ calculation of 9 categories of Kompan product line, version 1.0, prepared by: Bureau Veritas HSE, Denmark: Julie M. V. Larsen.

Publication date: 30. October 2023

By Bureau Veritas HSE
 www.bureauveritas.dk
 +45 7731 1000



Achiever

PCE206021

* Max fall height | ** Total height | *** Safety surfacing area

* Max fall height | ** Total height

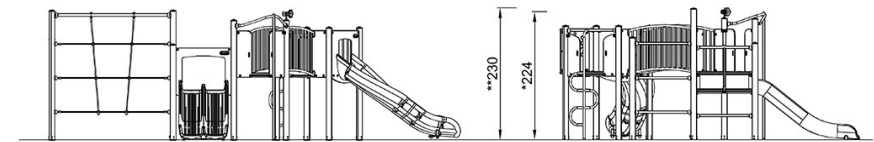
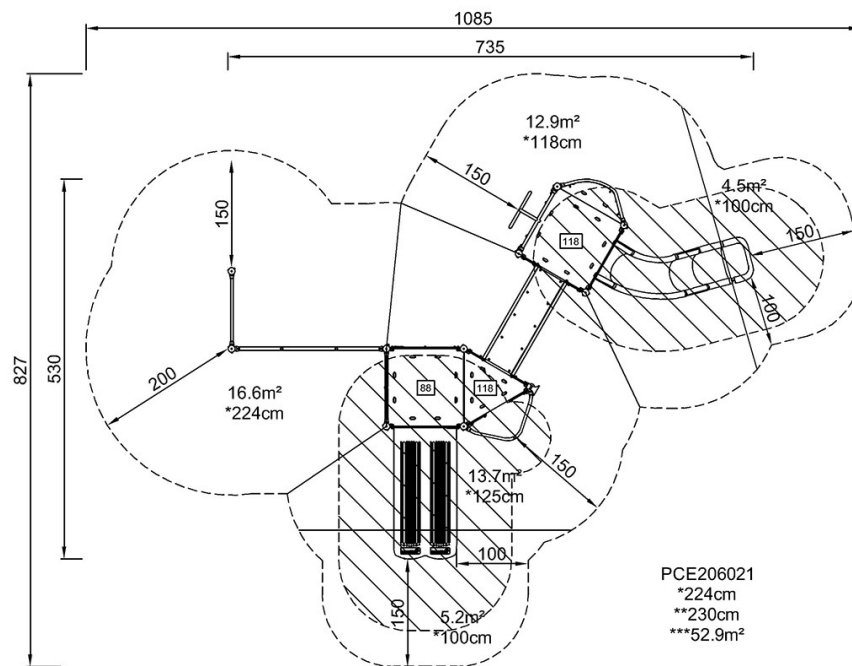

PCE206021

[Click to see TOP VIEW](#)

[Click to see SIDE VIEW](#)