

# Truck

M534

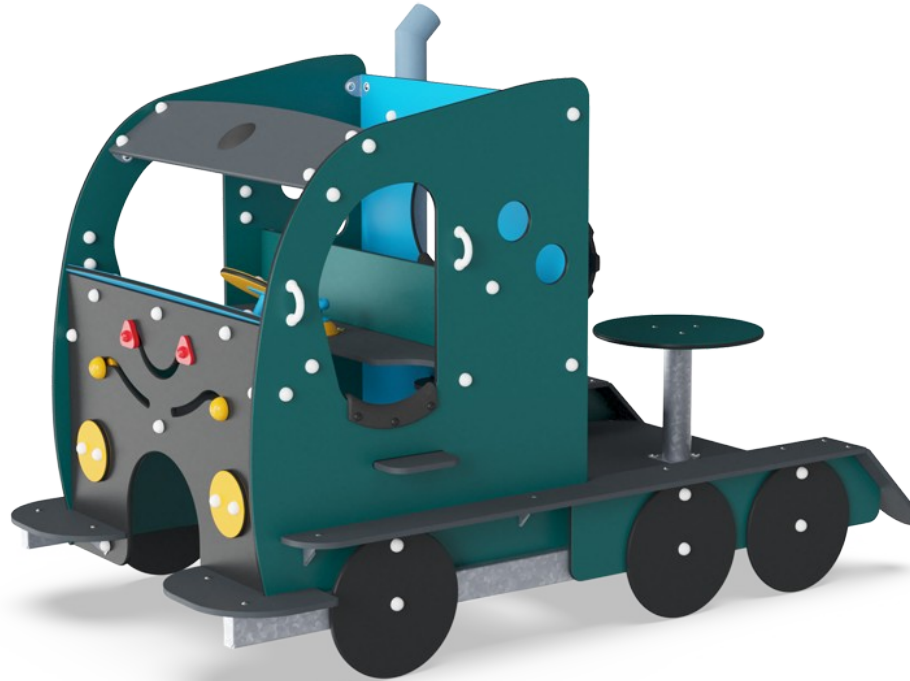

Item no. M53471-3418P

## General Product Information

Dimensions LxWxH	156x273x190 cm
Age group	6m+
Play capacity (users)	8
Colour options	



WOW – a truck! The Truck is a playground hit with all future drivers. With its spacious platforms and dens, it's an experience to explore. Thanks to the side, rear and front openings that allow children to enter from all sides, the driver's compartment stimulates versatile crawling. This enhances cross-coordination, which is important for the child's

ability to move body sides independently. This also helps to stimulate functions in the brain which are important to future reading skills. The truck's driving compartment has steering wheels and gears and numerous tactile elements. The back of the truck has a black crane hoisting wheel. These elements enhance cause-and-effect understanding when children

play with them. The back is a fine gathering space with a table and sides to sit on. This social space invites children and carers alike.

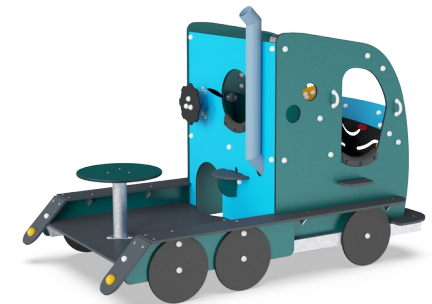

# Truck

M534

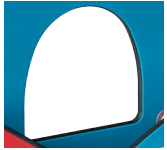

## Window

**Social-Emotional:** invites interaction between sides and cooperative play.



## Play sphere

**Social-Emotional:** can be played from both sides, encouraging cooperation. **Cognitive:** cause and effect understanding. **Creative:** leave a mark and place the spheres at different positions.



## Table

**Social-Emotional:** fine meeting place and a space creator. Sharing and cooperation create a social scenario that supports communication and cooperation.



## Theme

**Cognitive:** suggests a theme and supports dramatic play, which stimulates language and communication skills.



## Crawl-through hole

**Physical:** the hole allows for climbing and crawling through, developing cross coordination, proprioception and spatial awareness. **Social-Emotional:** cooperation and turn-taking when passing one another. **Cognitive:** understanding space, shape and measures when seeing if the body can fit through the hole.



## Turning wheel

**Cognitive:** the manipulative item stimulates cause and effect understanding.

# Truck

M534



Panels of 19mm EcoCore™. EcoCore™ is a highly durable, eco friendly material, which is not only recyclable after use, but also consists of material produced from +95% recycled post consumer material from food packing waste.

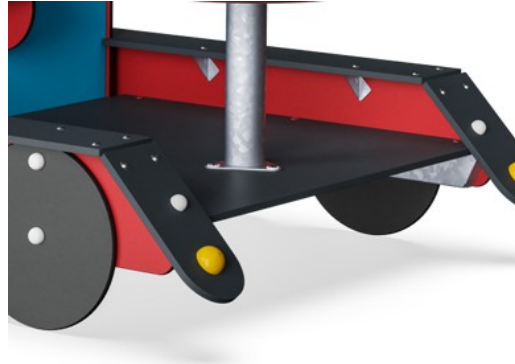

Foot support is made of HPL with a thickness of 17,8mm with a very high wearing strength and a unique KOMPAN nonskid surface texture.



The steel surfaces are hot dip galvanised inside and outside with lead free zinc. The galvanisation has excellent corrosion resistance in outside environments and requires low maintenance.

Item no. M53471-3418P

### Installation Information

Max. fall height	90 cm
Safety surfacing area	23.7 m <sup>2</sup>
Total installation time	12.6
Excavation volume	0.61 m <sup>3</sup>
Concrete volume	0.00 m <sup>3</sup>
Footing depth (standard)	63 cm
Shipment weight	419 kg
Anchoring options	In-ground ✓ Surface ✓

### Warranty Information

EcoCore HDPE	Lifetime
Hot dip galvanised steel	Lifetime
HPL decks	15 years
PUR components	10 years
Spare parts guaranteed	10 years



Exhaust pipe is made of polypropylene PP with excellent impact strength and usable within a large temperature span.

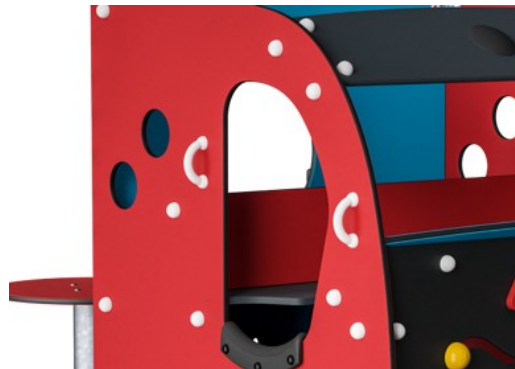

Handholds are made of injection moulded high quality nylon (PA6). PA6 has good wearing and impact strength.



KOMPAN GreenLine versions are designed with ultimate environmentally friendly materials with lowest possible CO<sub>2</sub>e emission factor such as EcoCore™ panels of +95% post consumer recycled ocean waste.



# Sustainability Data

M534

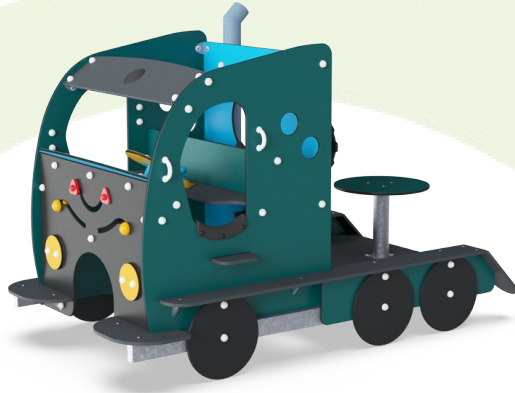

<b>Cradle to Gate A1-A3</b>	<b>Total CO<sub>2</sub> emission</b>	<b>CO<sub>2</sub>e/kg</b>	<b>Recycled materials</b>
	kg CO <sub>2</sub> e	kg CO <sub>2</sub> e/kg	%
<b>M53471-3418P</b>	586.53	1.73	49.25

The overall framework applied for these factors is the Environmental Product Declaration (EPD), which quantifies "environmental information on the life cycle of a product and enable comparisons between products fulfilling the same function" (ISO, 2006). This follows the structure and applies a Life-Cycle Assessment approach to the entire Product stage from raw material through manufacturing (A1-A3))

# Truck

M534

\* Max fall height | \*\* Total height | \*\*\* Safety surfacing area

\* Max fall height | \*\* Total height

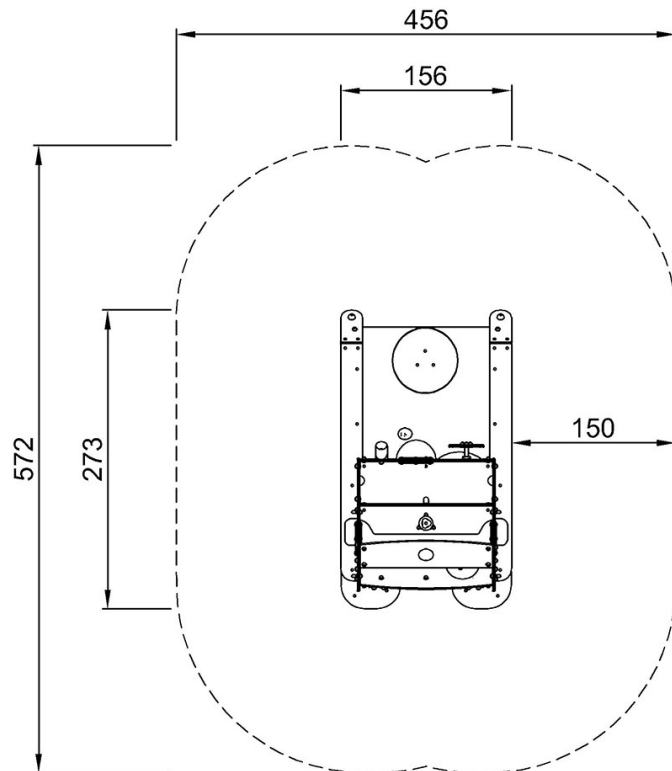

M53471  
\*90cm  
\*\*190cm  
\*\*\*23.7m<sup>2</sup>

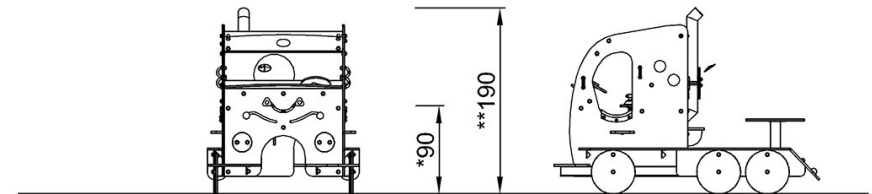

M53471

[Click to see TOP VIEW](#)

[Click to see SIDE VIEW](#)