

Spider Web Climbing Tower

COR22202

Item no. COR222021-1101

General Product Information

Dimensions LxWxH	46'6"x24'4"x9'10"
Age group	5 - 12
Play capacity (users)	33
Color options	

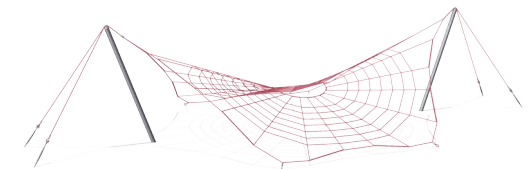
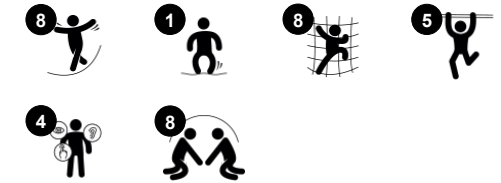
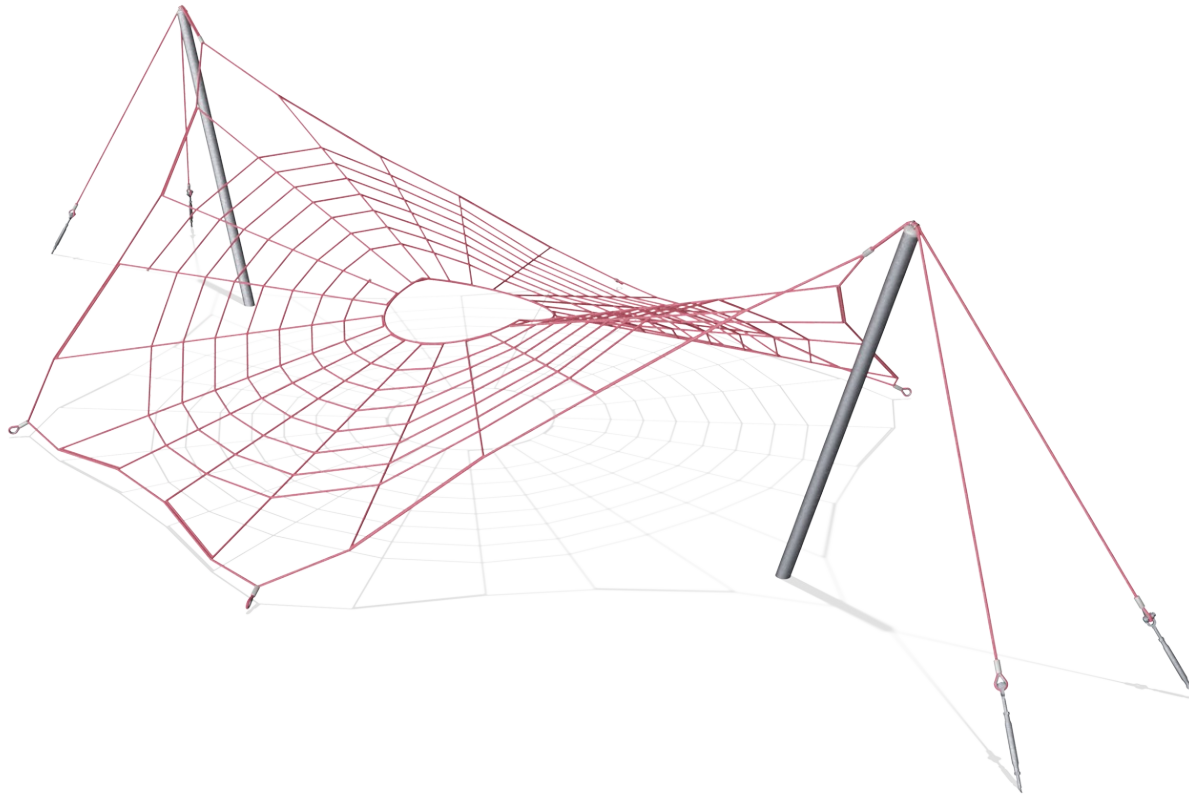

Wow! The spider web climbing tower sparks imagination that will thrill children with the opportunity to experience a spider-like climbing experience at their level.

The responsive ropes will move and bounce when children and adults enter into the web and begin to navigate the structure from side to side and from the edge to the middle. This

thrilling experience not only develops physical skills, such as agility, balance, and coordination, but it will encourage endurance as players challenge themselves over and over.

The careful design of the spider climbing net allows for vigorous play as well as for a more careful approach, and the ability to pause for

rest in the net, which will support the body in a lying position.

The simple structure of a climbing spider web playground encourages players to stay and play, developing their physical skills with an element of imagination.

Spider Web Climbing Tower

COR22202

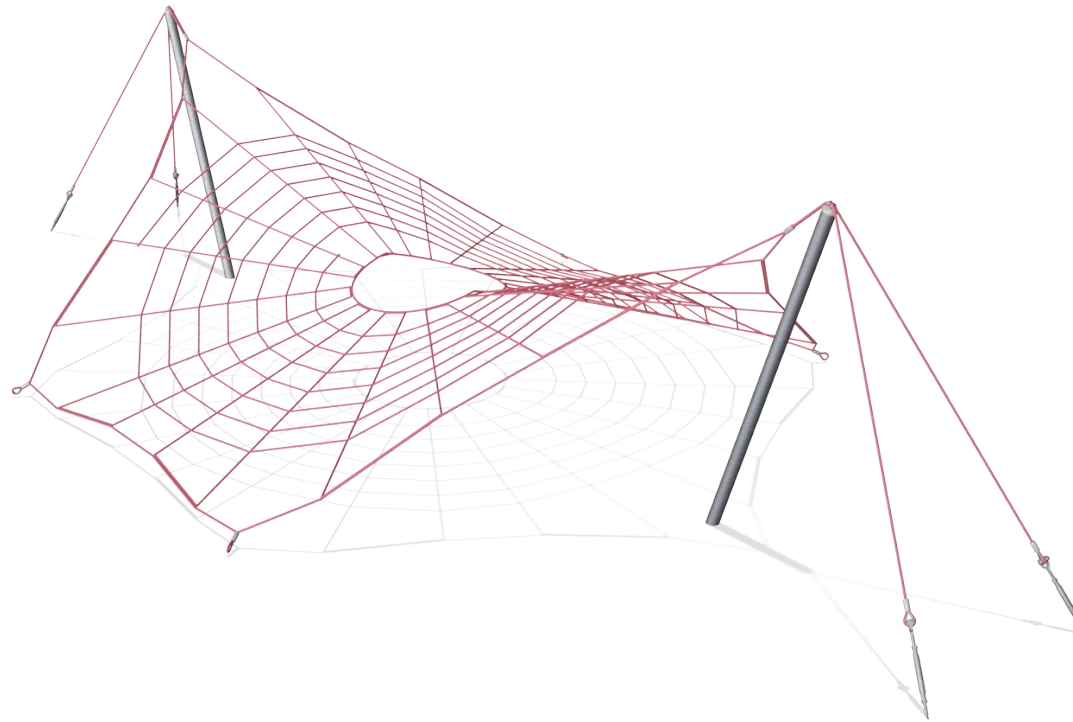

Circular mid-rung

Physical: hanging in arms trains upper body muscles. **Social-Emotional:** hanging in arms with friends stimulates endurance: who can hang in arms for the longest? Thrilling emotion and feeling of achievement when being at the highest point.



Inclined spider net

Physical: cross coordination, balance and spatial awareness are trained when climbing the net. All major muscles are active. **Social-Emotional:** the big meshes allow for more children to be together, sharing.

Spider Web Climbing Tower

COR22202



Corocord ropes with 19mm diameter or more are special 'Hercules' - type with galvanized six-stranded steel wires. Each strand is tightly wrapped with PES yarn, which is melted onto each individual strand. The ropes are highly wear-and vandalism-resistant and can be replaced at site if needed.



Corocord 'S' clamps are used as universal connections in Corocord products. 8mm stainless steel rods with rounded edges are pressed around the ropes with a special hydraulic press, making them the ideal connector: safe, durable and vandalism-proof, all while allowing the typical movement of rope play structures.



The steel structure are hot dip galvanized inside and outside with lead free zinc. The galvanization has excellent corrosion resistance in outside environments and requires low maintenance.



Through the KOMPAN Variant Team, you can choose between additional 7 rope colors and customize your solution. The assortment is a wide span of colors ranking from elegant and expressive black or a natural, neutral hemp color, to a range of attractive and eye-catching signal colors.

Item no. COR222021-1101	
Installation Information	
Max. fall height	7'7"
Safety surfacing area	1481ft ²
Total installation time	11.5
Excavation volume	12.2yd ³
Concrete volume	7.77yd ³
Footing depth (standard)	3'7"
Shipment weight	1120lbs
Anchoring options	In-ground ✓
Warranty Information	
Corocord Rope	10 Years
Hot dip galvanized steel	Lifetime
S-Clamps	10 Years
Spare Parts Availability	10 Years

Elevated activities 0	Accessible elevated activities	Accessible ground level activities	Accessible ground level play types
Present	0	1	1
Required	0	1	1

**ASTM
F1487**
compliant

Sustainability Data

COR22202

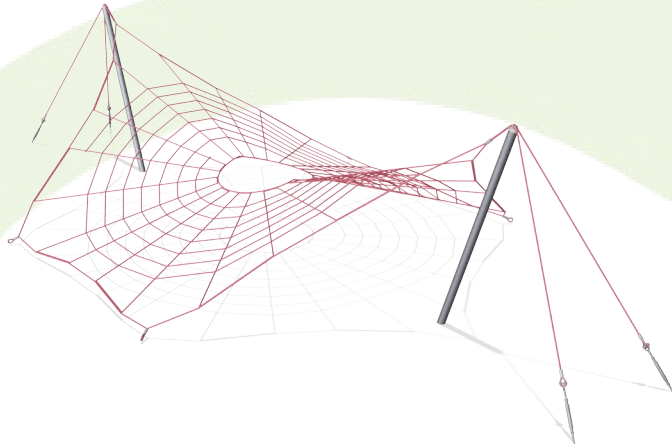

Cradle to Gate A1-A3	Total CO ₂ emission	CO ₂ e/kg	Recycled materials
	kg CO ₂ e	kg CO ₂ e/kg	%
COR222021-1101	1,292.95	2.99	54.04

The overall framework applied for these factors is the Environmental Product Declaration (EPD), which quantifies "environmental information on the life cycle of a product and enable comparisons between products fulfilling the same function" (ISO, 2006). This follows the structure and applies a Life-Cycle Assessment approach to the entire Product stage from raw material through manufacturing (A1-A3))

Kompan A/S
 C.F. Tietgens Boulevard 32C
 DK-5220 Odense SØ
 Denmark



Verification of CO₂ calculation of: Corocord



Data version no. 2023-10-05

The CO₂ calculation and data are in compliance with the principles of a carbon footprint impact according to the GHG protocol (Greenhouse Gas Protocol), Scope 3, cradle to gate related to all individual components in the product category: "Corocord" represented by item no.: COR314011-1101.

(Scope 3 emissions include emission sources in the upstream and downstream value chain).

Date: 30. October 2023 | Valid until: 30. October 2025

Verified by:

Julie Marie Vejsgaard Larsen, LCA & EPD Consultant

Verification based on report: Validation of CO₂ calculation of 9 categories of Kompan product line, version 1.0, prepared by: Bureau Veritas HSE, Denmark: Julie M. V. Larsen.

Publication date: 30. October 2023

By Bureau Veritas HSE
 www.bureauveritas.dk
 +45 7731 1000



Spider Web Climbing Tower

COR22202

* Max fall height | ** Total height | *** Safety surfacing area

* Max fall height | ** Total height

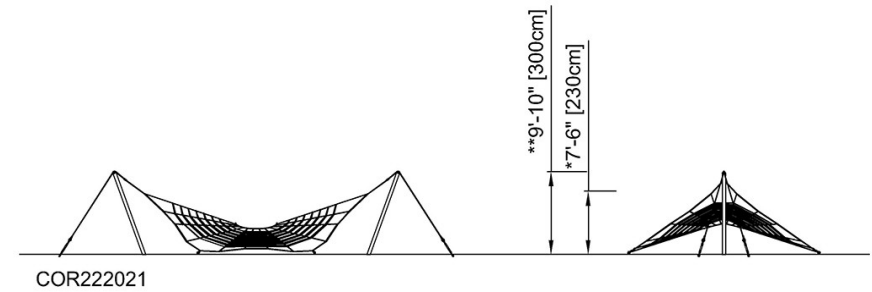
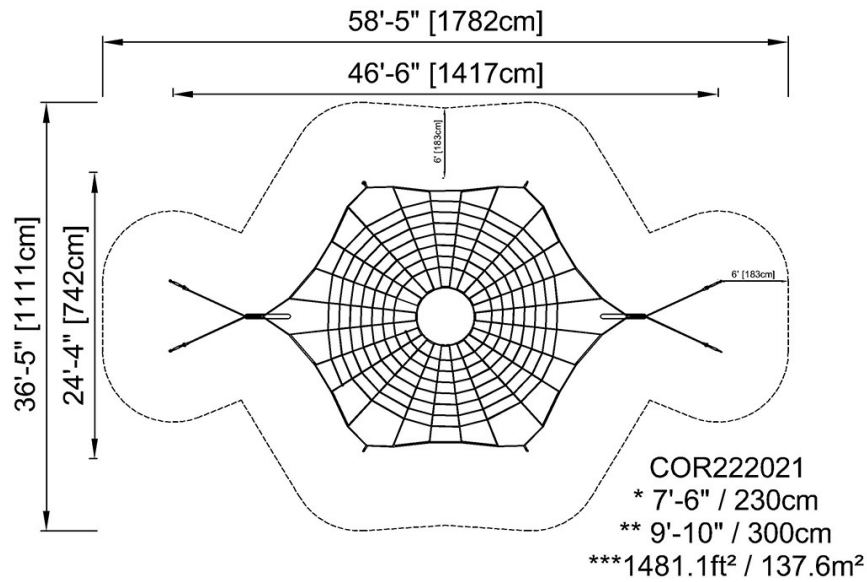

[Click to see TOP VIEW](#)

[Click to see SIDE VIEW](#)