

Embankment Slide, 2.5m high, 1.5m wide

KSL30703

KOMPANI
Let's play

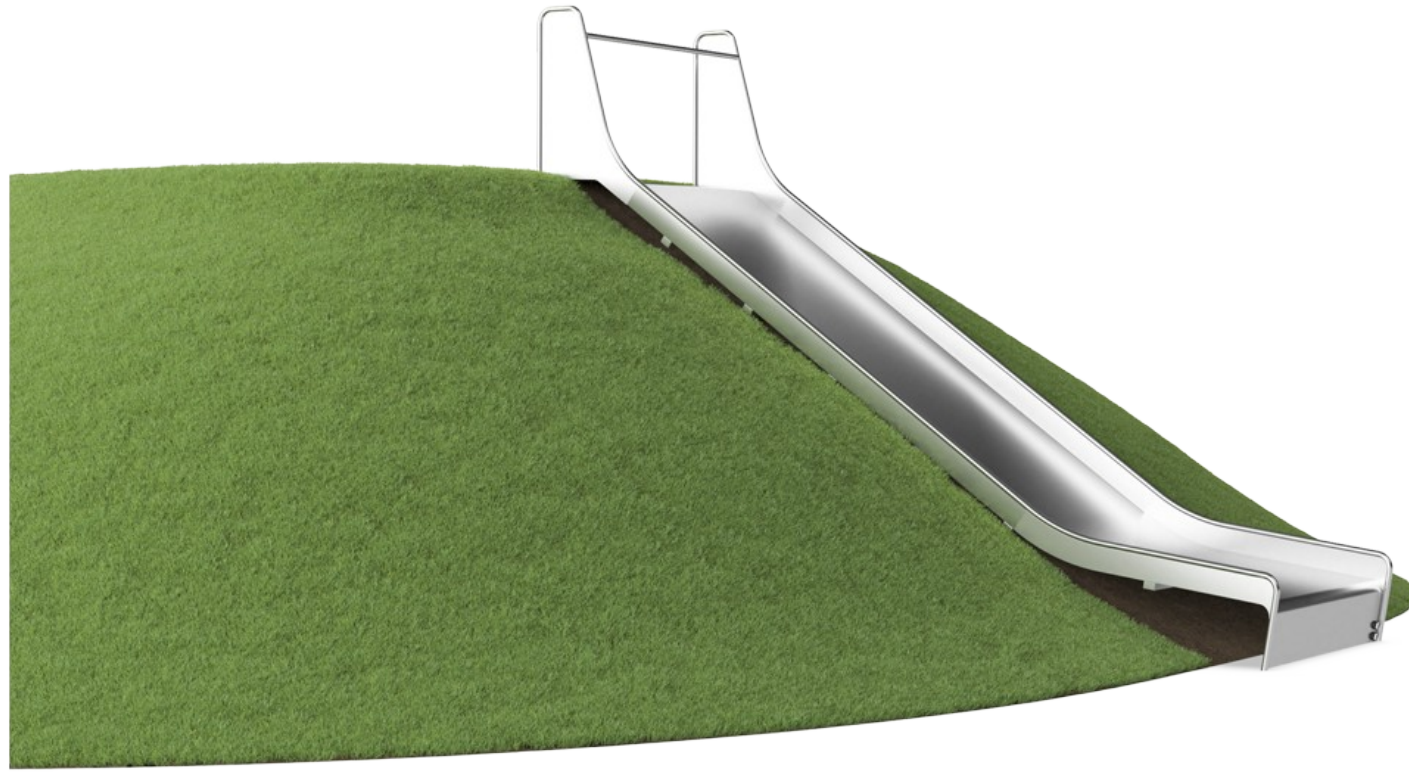

产品编号 KSL30703-0401

产品信息概览

| | |
|-------|----------------|
| 长宽高尺寸 | 525x154x347 cm |
| 适用年龄段 | 3+ |
| 容纳人数 | 2 |
| 颜色选择 | ● |



The extra wide Embankment Slide is extremely attractive. It makes children loop up hill and slide down again and again. The Embankment Slide will be a main attraction in a playground. Apart from the immense thrill of sliding, the Embankment Slide also supports children in developing important motor skills such as the sense of balance and space. These are

important in managing the world confidently and securely. The repeated loop of sliding and running back up is great training of cardio and muscle strength. The extra width adds a highly desirable rough-and-tumble element to play, when friends go down the slide together. This is a social-emotional benefit, which is further enhanced by the cooperation skills that

children use when slide together.

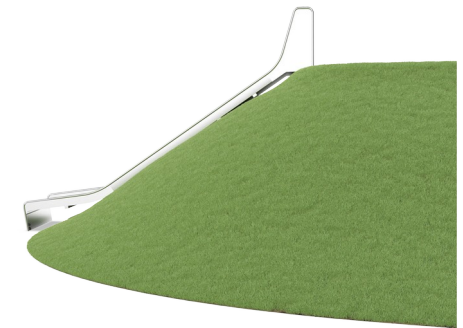

Embankment Slide, 2.5m high, 1.5m wide

KSL30703



Wide slide

身体素质：玩滑梯可以培养空间感和平衡感。此外，在直立向下坐时，核心肌肉也能得到锻炼。**社交情感：**鼓励社交游戏，支持亲子之间互动和同伴游戏。**认知能力：**幼儿在快速滑下时可训练对空间、速度和距离的理解。

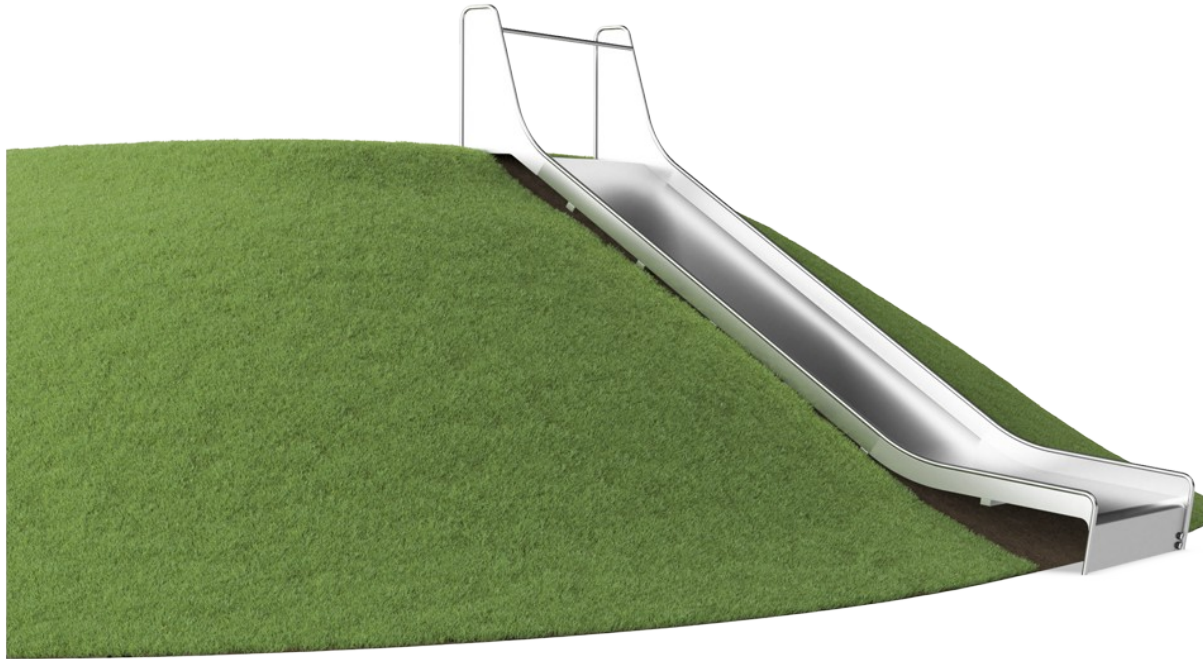

Embankment Slide, 2.5m high, 1.5m wide

KSL30703

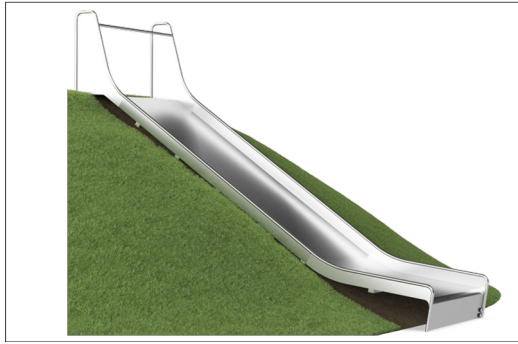

不锈钢组件由符合全球游乐场标准的优质不锈钢制成。钢材在制造后经过玻璃喷砂处理，以确保滑梯表面光滑。

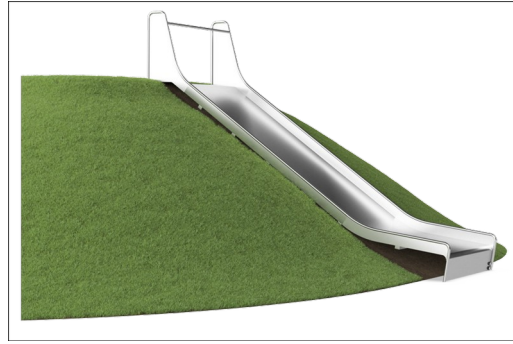

35 度是确保滑梯提供足够的乐趣以及必要的安全性的最佳角度。

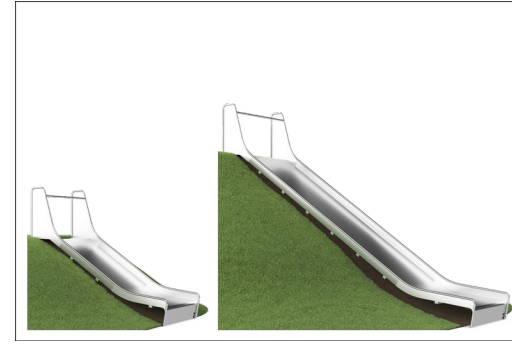

根据不同的地形，山坡滑梯有 9 种长度可供选择，在 1-3m 范围内可选。

产品编号 KSL30703-0401

安装信息

| | |
|--------|---------------------|
| 最大跌落高度 | 100 cm |
| 安全面积 | 30.0 m ² |
| 安装总时长 | 7.9 |
| 开挖量 | 1.16 m ³ |
| 混凝土使用量 | 0.74 m ³ |
| 标准入地深度 | 110 cm |
| 运输重量 | 511 kg |
| 固定选项 | 入地 ✓ |

质保信息

| | |
|-------|------|
| 承保零部件 | 10 年 |
| 不锈钢滑梯 | 10 年 |

EN
1176
compliant

Sustainability Data

KSL30703

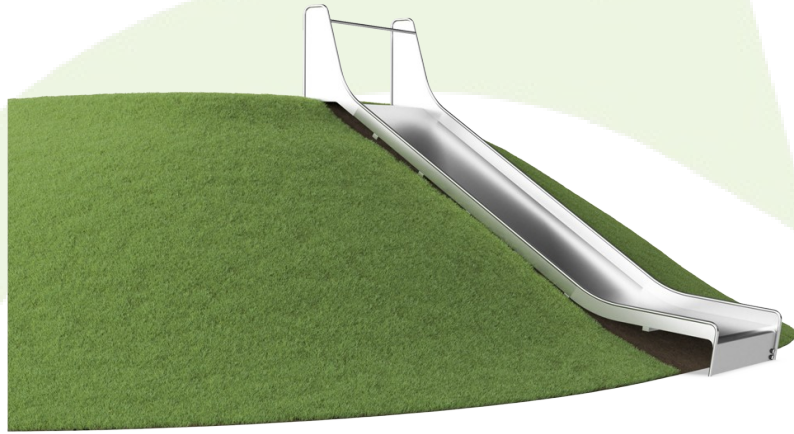

从原材料到成品

CO₂ 排放总量

kg CO₂e

CO₂ 排放量 / 千克

kg CO₂e/kg

回收的原料

%

KSL30703-0401

1,094.04

4.20

49.98

这些因素采用的总体框架为环保产品声明 (EPD), 该声明可量化“产品生命周期的环保信息, 并对相同功能的产品进行对比” (ISO, 2006)。在遵循该框架的同时, 对从原材料到制造的整个产品阶段 (A1-A3) 应用生命周期评估法。

Kompan A/S

C.F. Tietgens Boulevard 32C
DK-5220 Odense SØ
Denmark



Verification of CO₂ calculation of: Freestanding play equipment

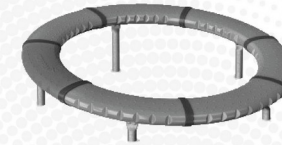

Data version no. 2023-10-05

The CO₂ calculation and data are in compliance with the principles of a carbon footprint impact according to the GHG protocol (Greenhouse Gas Protocol), Scope 3, cradle to gate related to all individual components in the product category: "Freestanding play equipment" represented by item no.: GXY916012-3417.

(Scope 3 emissions include emission sources in the upstream and downstream value chain).

Date: 30. October 2023 | Valid until: 30. October 2025

Verified by:

Julie Marie Vejsgaard Larsen, LCA & EPD Consultant

Verification based on report: Validation of CO₂ calculation of 9 categories of Kompan product line, version 1.0, prepared by: Bureau Veritas HSE, Denmark: Julie M. V. Larsen.

Publication date: 30. October 2023

By Bureau Veritas HSE

www.bureauveritas.dk

+45 7731 1000



Embankment Slide, 2.5m high, 1.5m wide

KSL30703

最大跌落高度 | 总高度 | 安全区域

最大跌落高度 | 总高度

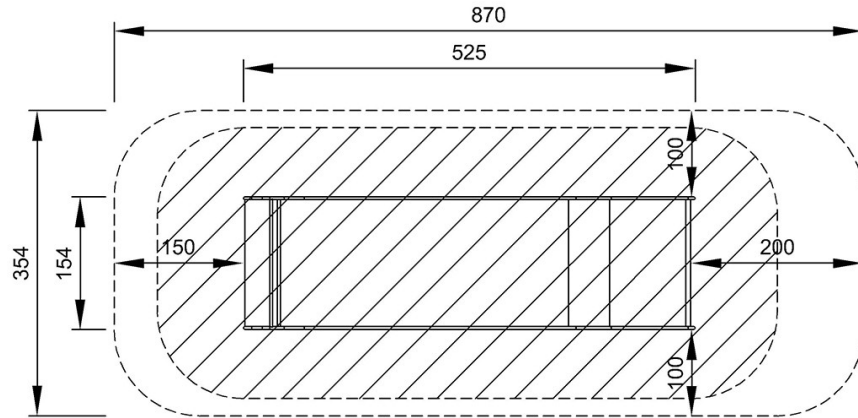

KSL30703
*100cm
**347cm
***30m²

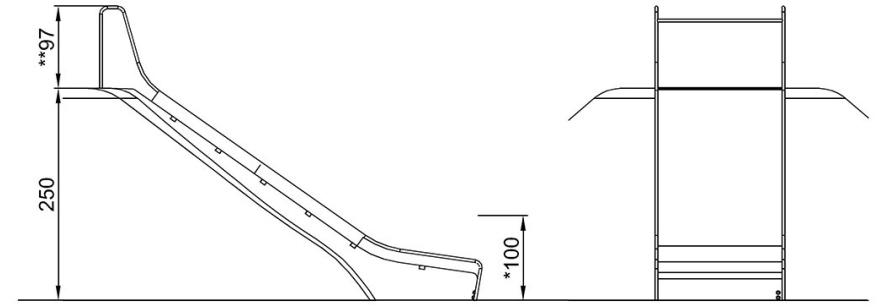

KSL30703

[点击查看俯视图](#)

[点击查看侧面图](#)