

Home & Ocean with Net & Tower

MSC6405

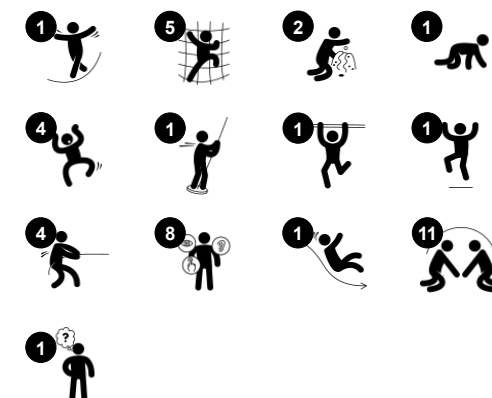

Item no. MSC640500-3717P	
General Product Information	
Dimensions LxWxH	731x415x285 cm
Age group	2+
Play capacity (users)	29
Color options	●



WOW! The roomy Home & Ocean themes hugely appeal to children's dramatic play stories. The ground level den invites a break with friends. There is a Home side and an Ocean side, inspiring vigorous play stories. Thanks to the two-sided themed panels and the varied climbers: curved, round, straight and net climbers, there are challenges for a wide

user group. The climbing events, slides and glides train motor skills, such as cross-coordination and balance, important for navigating the world confidently. There are so many meeting points as the Home & Ocean can be played in from all sides. The huge net adds volume and creates active meetings. From the upper level, children can look

communicate through the window with those on the ground level so the social play possibility is immense. Children meet, greet and play, making friends for life.



Home & Ocean with Net & Tower

MSC6405



Rock climber

Physical: supports cross coordination and leg, arm and hand strength. **Social-Emotional:** the inclination makes climbing feel secure, especially for younger children.



Slide

Physical: sliding develops spatial awareness and a sense of balance. Furthermore, the core muscles are trained when sitting upright going down. **Social-Emotional:** empathy stimulated by turn-taking. **Cognitive:** young children develop their understanding of space, speed and distances when sliding down quickly.



Fireman's pole

Physical: coordination is supported when going down, as well as arm and core muscles. Landing strengthens bone density, which is built for life in early childhood. **Social-Emotional:** turn-taking and risk-taking. **Cognitive:** young children develop their understanding of space, speed and distances when gliding down fast.



Climbing net

Physical: children develop cross-body coordination and muscle strength. The asymmetry of the net challenges the children's climbing.



Binoculars

Cognitive: the binoculars set a tangible theme and thus spur dramatic play. Dramatic play is a great trainer of language and communication skills. **Creative:** the binoculars can be turned in all directions. Looking through them gives a new perspective on the world.



Den

Physical: crawling through the possible openings trains spatial awareness. **Social-Emotional:** the enclosed space invites social play for two or three children.



Crawl-through hole

Physical: the hole allows for climbing and crawling through, developing cross coordination, proprioception and spatial awareness. **Social-Emotional:** cooperation and turn-taking when passing one another. **Cognitive:** understanding space, shape and measures when seeing if the body can fit through the hole.

Home & Ocean with Net & Tower

MSC6405

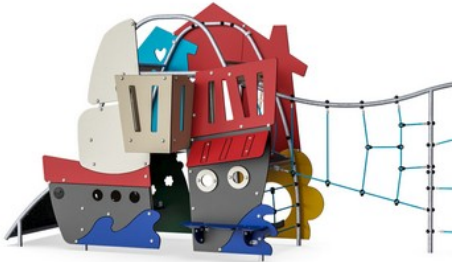

Panels of 19mm EcoCore™. EcoCore™ is a highly durable, eco friendly material, which is not only recyclable after use, but also consists of material produced from +95% recycled post consumer material from food packing waste.

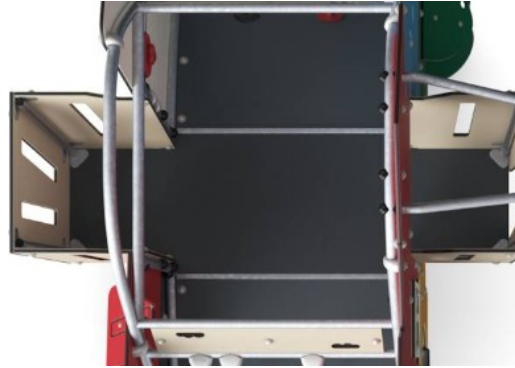

All floors are made of High-Pressure Laminate HPL with a thickness 17.8mm and non skid surface texture according to EN 438-6. KOMPAN HPL has high wearing strength to ensure long lifetime in all climates.

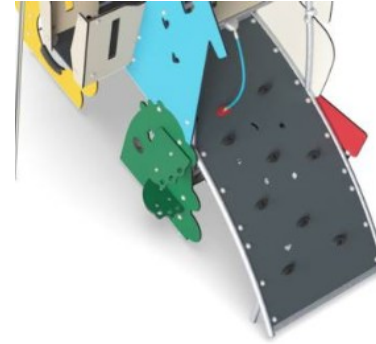

Curved climbing wall is made of Ekogrip® panel that consist of a 15mm thick PE base with 3 mm top-layer of soft rubber with a non-skid effect.

Item no. MSC640500-3717P

Installation Information

Max. fall height	193 cm
Safety surfacing area	47.2 m ²
Total installation time	30.7
Excavation volume	1.47 m ³
Concrete volume	0.00 m ³
Footing depth (standard)	90 cm
Shipment weight	958 kg
Anchoring options	In-ground ✓ Surface ✓



Molded PE slides made with 33% post-consumer materials in different colors in one-piece design with a wall thickness of minimum 5mm. The PE is tested for UV stability and has excellent impact strength and it is usable within a large temperature span.

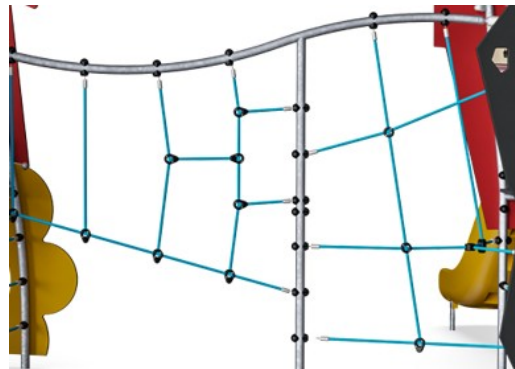

Climbing nets are made of UV-stabilised PP rope with inner steel cable reinforcement. The rope is induction treated to obtain maximum fixation between steel and rope which provides excellent wear and tear resistance. All rope connectors are made of 100% recyclable PA material.



The steel surfaces are hot dip galvanised inside and outside with lead free zinc. The galvanisation has excellent corrosion resistance in outside environments and requires low maintenance.



Sustainability Data

MSC6405



Cradle to Gate A1-A3	Total CO ₂ emission	CO ₂ e/kg	Recycled materials
	kg CO ₂ e	kg CO ₂ e/kg	%
MSC640500-3717P	1,754.62	2.24	54.68

The overall framework applied for these factors is the Environmental Product Declaration (EPD), which quantifies "environmental information on the life cycle of a product and enable comparisons between products fulfilling the same function" (ISO, 2006). This follows the structure and applies a Life-Cycle Assessment approach to the entire Product stage from raw material through manufacturing (A1-A3))

Kompan A/S
 C.F. Tietgens Boulevard 32C
 DK-5220 Odense SØ
 Denmark



Verification of CO₂ calculation of: Themed play systems



Data version no. 2023-10-05

The CO₂ calculation and data are in compliance with the principles of a carbon footprint impact according to the GHG protocol (Greenhouse Gas Protocol), Scope 3, cradle to gate related to all individual components in the product category: "Themed play systems" represented by item no.: MSC641100-3717P.

(Scope 3 emissions include emission sources in the upstream and downstream value chain).

Date: 30. October 2023 | Valid until: 30. October 2025

Verified by:

Julie Marie Vejsgaard Larsen, LCA & EPD Consultant

Verification based on report: Validation of CO₂ calculation of 9 categories of Kompan product line, version 1.0, prepared by: Bureau Veritas HSE, Denmark: Julie M. V. Larsen.

Publication date: 30. October 2023

By Bureau Veritas HSE
 www.bureauveritas.dk
 +45 7731 1000



Home & Ocean with Net & Tower

MSC6405

* Max fall height | ** Total height | *** Safety surfacing area

* Max fall height | ** Total height

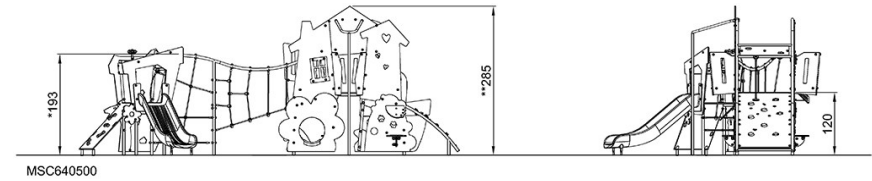
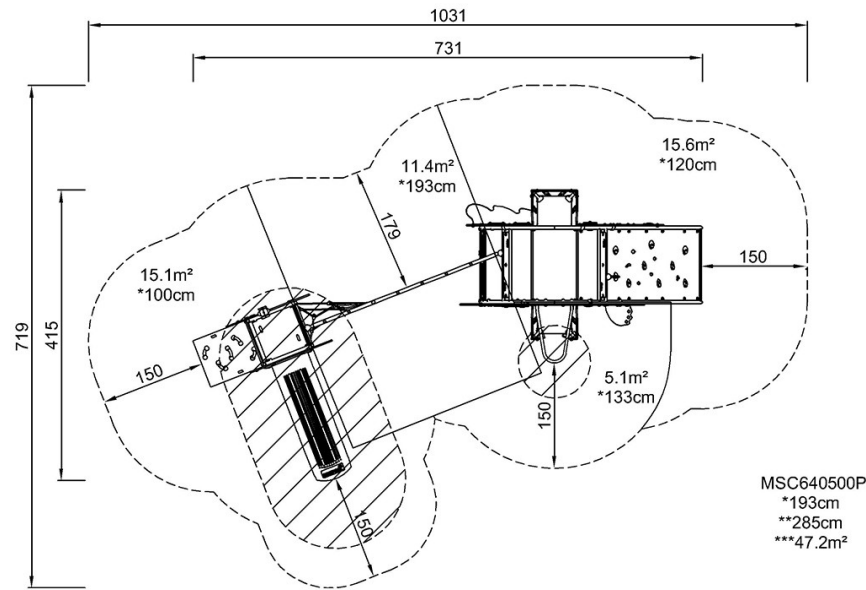

[Click to see TOP VIEW](#)

[Click to see SIDE VIEW](#)