

# Chalk Board, Large

PCM0012

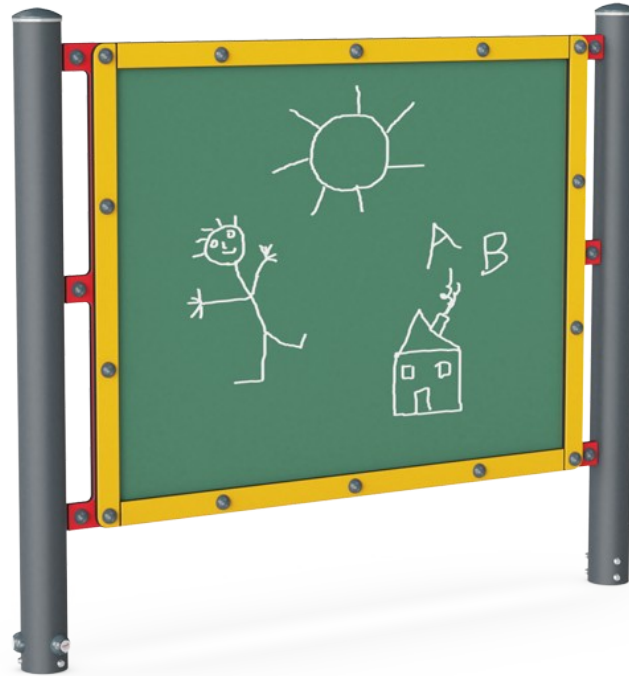

Item no. PCM001208-0902	
<b>General Product Information</b>	
Dimensions LxWxH	166x12x140 cm
Age group	2+
Play capacity (users)	4
Colour options	



This large chalkboard will support hours of play and learning in an outdoor learning environment or playground. The large space is plenty for many children to join in the mark-making and drawing, which will help them to develop fine motor skills when drawing, and language and literacy skills when making signs. The large size supports social play because

there is plenty of room for interaction and cooperation. Chalkboards can have direct benefits for learning, and they also enhance a variety of dramatic play scenarios, from playing school to making a sign for treasure hunting games. There are cognitive benefits to drawing and leaving your mark, because it stimulates brain development, creative thinking and thus

problem-solving skills.



# Chalk Board, Large

PCM0012

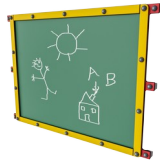

## Chalkboard

**Social-Emotional:** the width of the blackboard caters for groups of children cooperating and sharing ideas. **Creative:** drawing and leaving your mark stimulates creative thinking.

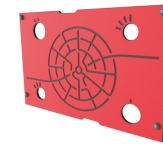

## Labyrinth panel

**Social-Emotional:** communication and cooperation exploring the maze with friends. **Cognitive:** stimulates memory when memorising maze routes.

# Chalk Board, Large

PCM0012

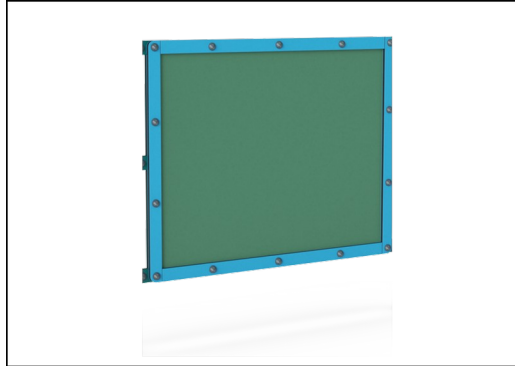

Board is made of ceramic steel. Ceramic steel has high corrosion resistance, and it is 100% recyclable.



Main posts with hot dip galvanized steel footing are available in different materials: Pressure impregnated pine wood posts. Pre-galvanized inside and outside with powder coated top finish steel posts. Lead free aluminum with color anodized top finish. Greenline TexMade posts of 95% post-consumer recycled PE and textile waste.

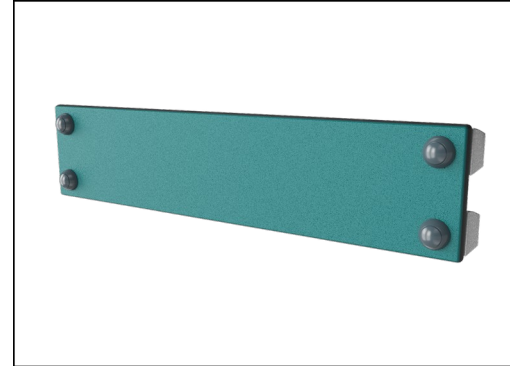

Panels of 19mm EcoCore™. EcoCore™ is a highly durable, eco-friendly material, which is not only recyclable after use but also consists of a core produced from 100% recycled material.

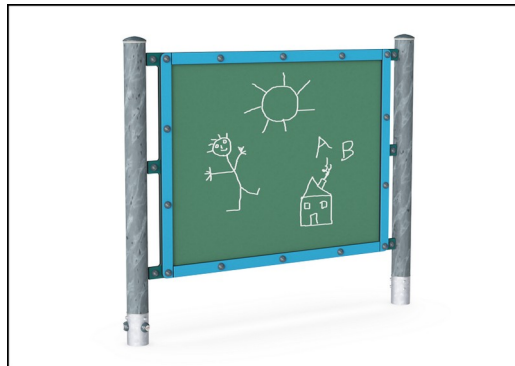

KOMPAN GreenLine versions are designed with ultimate environmentally friendly materials with the lowest possible CO2e emission factor such as EcoCore™ panels of 100% post consumer recycled ocean waste.

Item no. PCM001208-0902

### Installation Information

Max. fall height	0 cm
Safety surfacing area	12.3 m <sup>2</sup>
Total installation time	3.8
Excavation volume	0.05 m <sup>3</sup>
Concrete volume	0.00 m <sup>3</sup>
Footing depth (standard)	85 cm
Shipment weight	86 kg
Anchoring options	Surface ✓ In-ground ✓

### Warranty Information

EcoCore HDPE	Lifetime
Post	10 years
Spare Parts Guarantee	10 years



# Sustainability Data

PCM0012

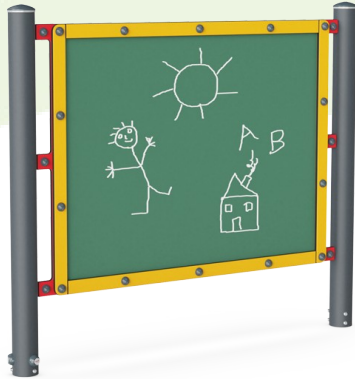

Cradle to Gate A1-A3	Total CO <sub>2</sub> emission	CO <sub>2</sub> e/kg	Recycled materials
	kg CO <sub>2</sub> e	kg CO <sub>2</sub> e/kg	%
PCM001208-0950	80.08	1.16	82.96
PCM001208-0902	95.25	1.56	76.62

The overall framework applied for these factors is the Environmental Product Declaration (EPD), which quantifies "environmental information on the life cycle of a product and enable comparisons between products fulfilling the same function" (ISO, 2006). This follows the structure and applies a Life-Cycle Assessment approach to the entire Product stage from raw material through manufacturing (A1-A3))

**Kompan A/S**  
C.F. Tietgens Boulevard 32C  
DK-5220 Odense SØ  
Denmark



## Verification of CO<sub>2</sub> calculation of: Themed play systems



Data version no. 2023-10-05

The CO<sub>2</sub> calculation and data are in compliance with the principles of a carbon footprint impact according to the GHG protocol (Greenhouse Gas Protocol), Scope 3, cradle to gate related to all individual components in the product category: "Themed play systems" represented by item no.: MSC641100-3717P.

(Scope 3 emissions include emission sources in the upstream and downstream value chain).

**Date: 30. October 2023 | Valid until: 30. October 2025**

Verified by:

Julie Marie Vejsgaard Larsen, LCA & EPD Consultant

Verification based on report: Validation of CO<sub>2</sub> calculation of 9 categories of Kompan product line, version 1.0, prepared by: Bureau Veritas HSE, Denmark: Julie M. V. Larsen.

**Publication date: 30. October 2023**

By Bureau Veritas HSE  
www.bureauveritas.dk  
+45 7731 1000



# Chalk Board, Large

PCM0012

\* Max fall height | \*\* Total height | \*\*\* Safety surfacing area

\* Max fall height | \*\* Total height

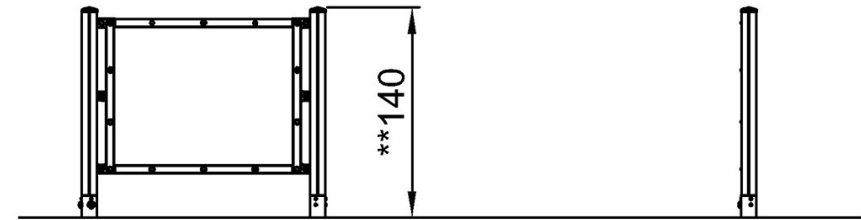
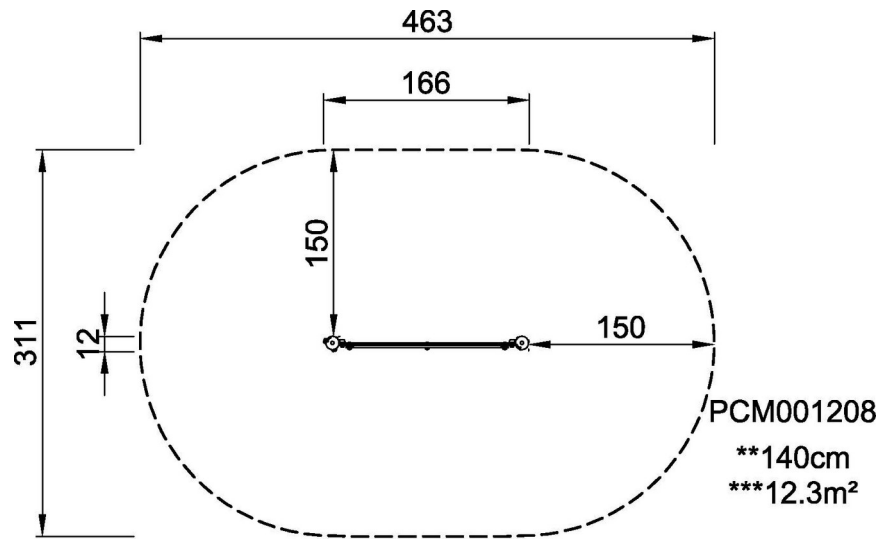

PCM001208  
1:100

[Click to see TOP VIEW](#)

[Click to see SIDE VIEW](#)