

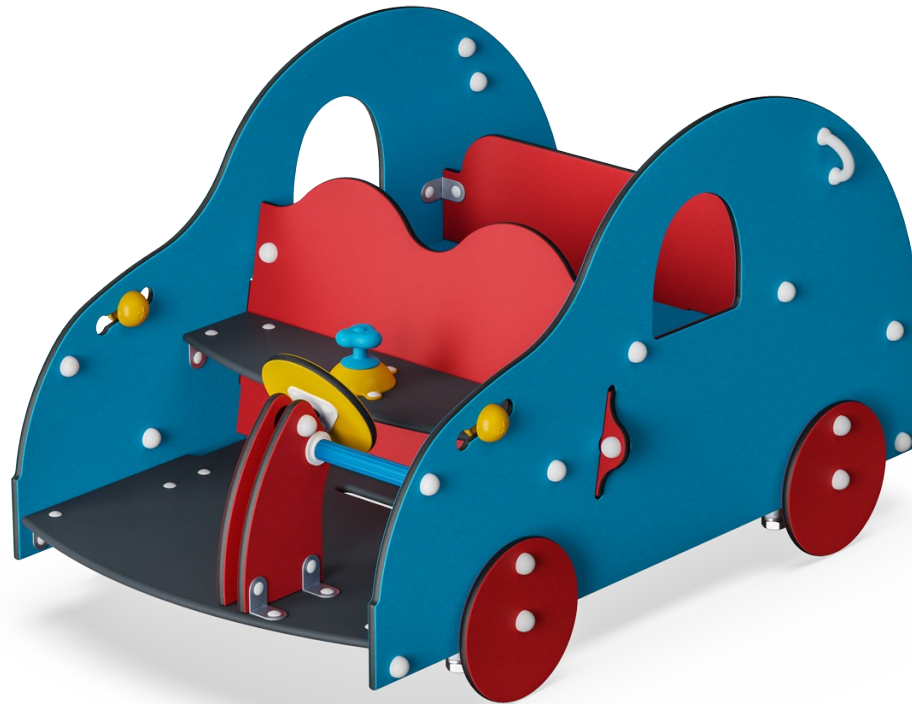

Mini Car

M531



Item no. M53170-3313P

General Product Information

| | |
|-----------------------|---|
| Dimensions LxWxH | 103x176x98 cm |
| Age group | 6m+ |
| Play capacity (users) | 6 |
| Colour options |  |

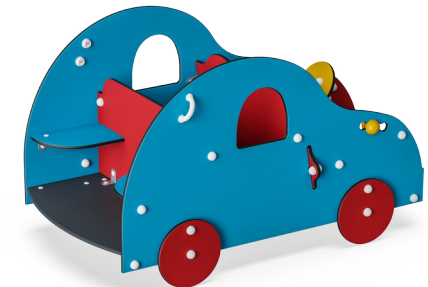
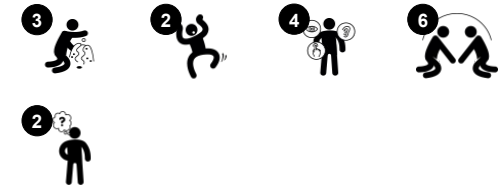

Where do you want to go? This friendly little car is spacious enough to hold six children. Perhaps a holiday trip, a journey to work or just visiting friends - whatever the destination, the Mini Car is ready to drive children anywhere they want to go. This little blue car is equipped with a steering wheel that makes an exciting sound when turned from side to side, and a

gear stick, as well as movable indicator lights made of strong synthetic material.



Mini Car

M531



Bench

Social-Emotional: gathering, cooperating or taking a break from play - all train social skills.

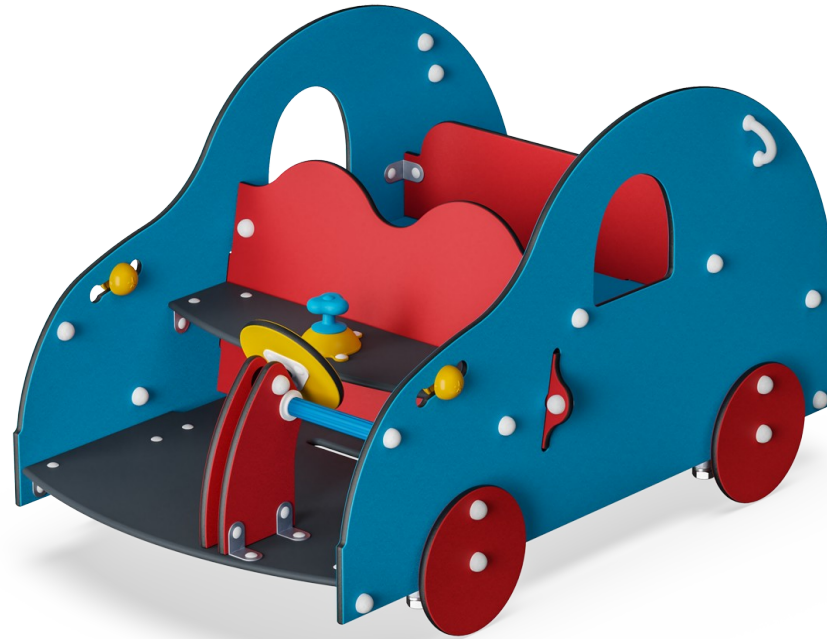

Play sphere

Social-Emotional: can be played from both sides, encouraging cooperation. **Cognitive:** cause and effect understanding. **Creative:** leave a mark and place the spheres at different positions.

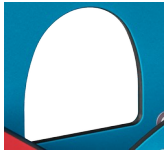

Window

Social-Emotional: invites interaction between sides and cooperative play.



Theme

Cognitive: suggests a theme and supports dramatic play, which stimulates language and communication skills.



Gear shift

Social-Emotional: cooperation, turn-taking, sharing. **Cognitive:** suggests a theme and supports dramatic play, which stimulates languages skills.



Turning wheel

Cognitive: the manipulative item stimulates cause and effect understanding.

Mini Car

M531

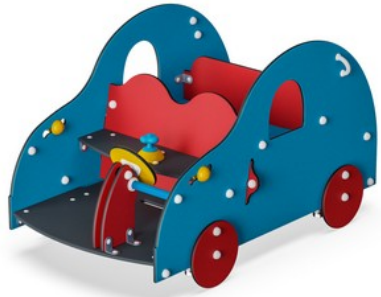

Panels of 19mm EcoCore™. EcoCore™ is a highly durable, eco friendly material, which is not only recyclable after use, but also consists of material produced from +95% recycled post consumer material from food packing waste.

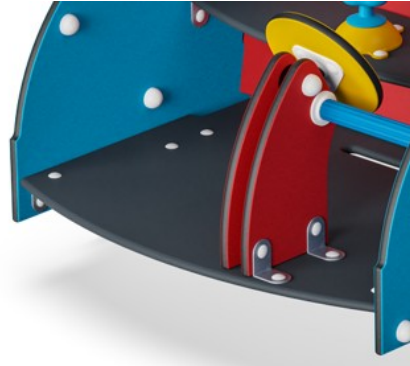

Foot support is made of HPL with a thickness of 17,8mm with a very high wearing strength and a unique KOMPAN nonskid surface texture.



Handle is made of polypropylene PP with excellent impact strength and usable within a large temperature span.

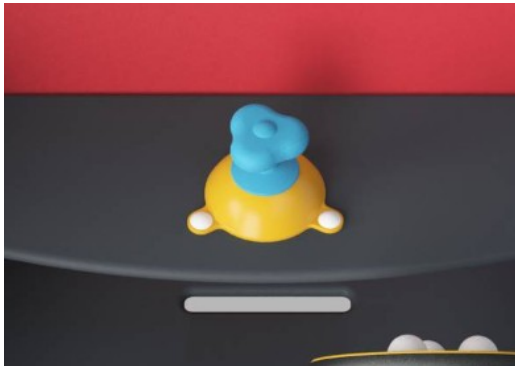

Gear shift is made of PP. PP has good wearing and impact resistance.

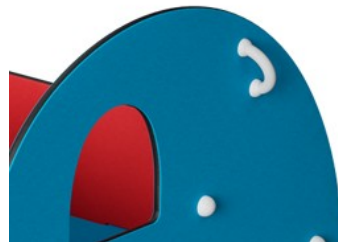

Handholds are made of injection moulded high quality nylon (PA6). PA6 has good wearing and impact strength.

Item no. M53170-3313P

Installation Information

| | |
|--------------------------|--------------------------|
| Max. fall height | 45 cm |
| Safety surfacing area | 17.3 m ² |
| Total installation time | 5.6 |
| Excavation volume | 0.15 m ³ |
| Concrete volume | 0.00 m ³ |
| Footing depth (standard) | 42 cm |
| Shipment weight | 215 kg |
| Anchoring options | In-ground ✓ Surface ✓ |

Warranty Information

| | |
|--------------------------|----------|
| EcoCore HDPE | Lifetime |
| Hot dip galvanised steel | Lifetime |
| HPL decks | 15 years |
| PE/PP components | 5 years |
| Spare parts guaranteed | 10 years |



Sustainability Data

M531

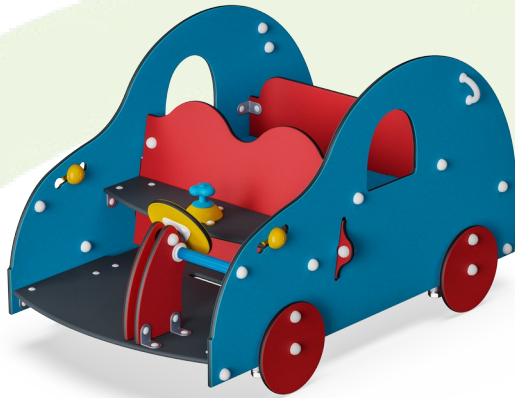

| Cradle to Gate A1-A3 | Total CO₂ emission | CO₂e/kg | Recycled materials |
|-----------------------------|--------------------------------------|---------------------------|---------------------------|
| | kg CO ₂ e | kg CO ₂ e/kg | % |
| M53170-3313P | 223.84 | 1.60 | 55.59 |

The overall framework applied for these factors is the Environmental Product Declaration (EPD), which quantifies "environmental information on the life cycle of a product and enable comparisons between products fulfilling the same function" (ISO, 2006). This follows the structure and applies a Life-Cycle Assessment approach to the entire Product stage from raw material through manufacturing (A1-A3))

Mini Car

M531

* Max fall height | ** Total height | *** Safety surfacing area

* Max fall height | ** Total height

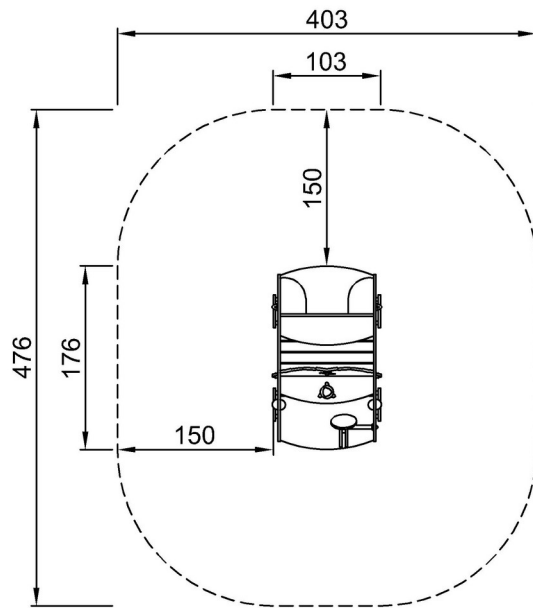

M53170P
*45cm
**98cm
***17.3m²



M53170P

[Click to see TOP VIEW](#)

[Click to see SIDE VIEW](#)