

Double Zipline, Sloped Space, 82 ft Long

M88101

Item no. M88101-3817

General Product Information

Dimensions LxWxH	109'0"x16'6"x9'9"
Age group	5 - 12
Play capacity (users)	2
Color options	●

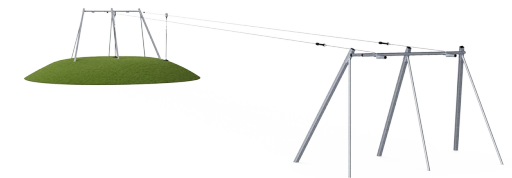
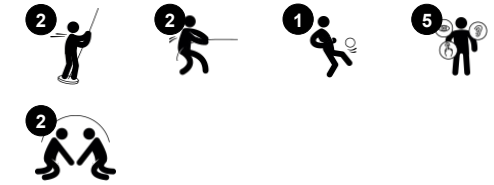
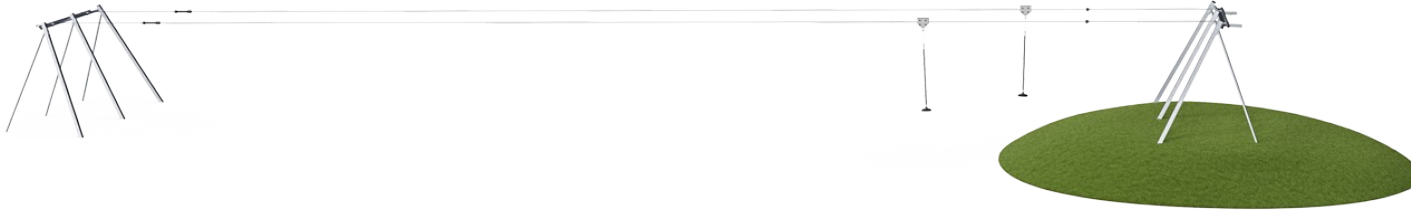

The Double Zipline is the ultimate social daredevil attraction. It will support social play again and again with children racing each other to the end and competing for speed as they go. And they will go, over and over. The reason for this strong holding power lies mainly in the immense thrill of gliding through the air. The feeling of weightlessness and the swooshing

through the air trains spatial awareness as well as the child's understanding of gravity, space and speed. This is necessary for real life, for example, in managing traffic safely. Social skills are practiced as children diligently hand back the seat to the next user in line. The running and pulling involved in this train the child's cardio endurance as well as upper body

muscles. All in all, the large zipline is an asset of play that unites generations and abilities with ways for almost everyone to use it.

Double Zipline, Sloped Space, 82 ft Long

M88101



Dino seat

Physical: the three divisions and chains of the seat provide efficient handholds for both standing and seated swinging. **Social-Emotional:** the possibility of children swinging together, legs hanging down, trains cooperation, sequencing and turn-taking when swinging.

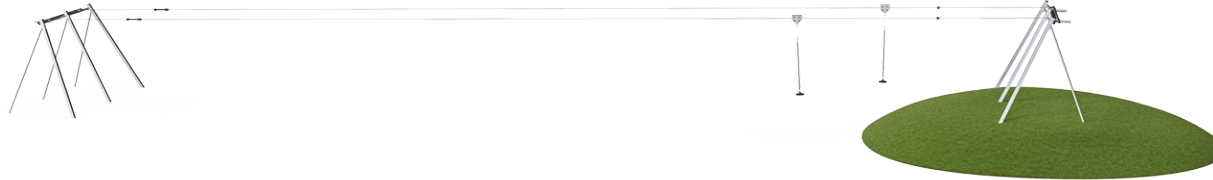

Long line

Physical: the lengthy glide through the air adds to the thrill and trains spatial awareness, trunk stability and upper-body muscles. All this helps support the child's physical self esteem, making e.g. positive risk taking easier.



PUR covered rope

Physical: firm grip when spinning and hanging from arms. Arm muscles developed when holding tight.



Double zipline

Social-Emotional: the possibility to glide with a companion or have friendly competitions supports turn taking and cooperation skills. **Cognitive:** the speed may differ between the two Ziplines. Figuring out the reason behind this (weight, speed, force etc.) trains logical thinking.

Double Zipline, Sloped Space, 82 ft Long

M88101



The steel surfaces are hot-dip galvanized inside and outside with lead-free zinc. The galvanization has excellent corrosion resistance in outside environments and requires minimal maintenance.



The special designed seat is made of a steel insert covered with a soft layer of silicon rubber. The seat is impact tested to fulfill all global playground standards and the rope has an ergonomic handhold.



The high-quality steel cable with a diameter of 12mm is designed for heavy usage of the cableway for many years. The starting point is indicated by a knob. At the stop point there is special designed spring device ensuring a softer stop of the puller.

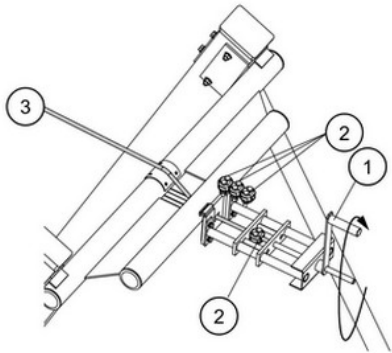

The steel cable 3 is tensioned by a special designed device. By turning the handle 1 the steel cable can be tensioned according to instruction in a safe way. After tensioning the cable is locked by three clamps 2. The tensioning device can also be used for adjustment during annual inspections.

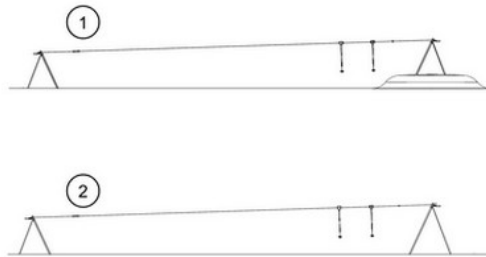

KOMPAN cableways are available for flat or natural sloped surroundings and for surface or in-ground installation. Further the cableways can be supplied with one or two cables for children to ride together in friendly competition.

Item no. M88101-3817	
Installation Information	
Max. fall height	6'11"
Safety surfacing area	2551ft ²
Total installation time	17.7
Excavation volume	15.39yd ³
Concrete volume	4.96yd ³
Footing depth (standard)	3'3"
Shipment weight	1437lbs
Anchoring options	In-ground ✓
Warranty Information	
Cable	10 Years
Hot dip galvanized steel	Lifetime
Movable parts	2 Years
Rubber seat	2 Years
Spare Parts Availability	10 Years

Elevated activities 0	Accessible elevated activities	Accessible ground level activities	Accessible ground level play types
Present	0	1	1
Required	0	1	1



Sustainability Data

M88101

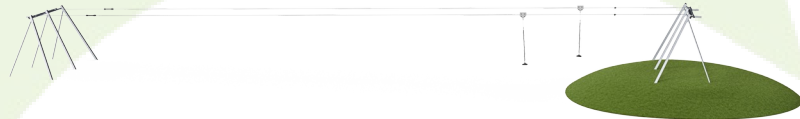

Cradle to Gate A1-A3	Total CO ₂ emission	CO ₂ e/kg	Recycled materials
	kg CO ₂ e	kg CO ₂ e/kg	%
M88101-3817	1,812.38	2.58	49.76

The overall framework applied for these factors is the Environmental Product Declaration (EPD), which quantifies "environmental information on the life cycle of a product and enable comparisons between products fulfilling the same function" (ISO, 2006). This follows the structure and applies a Life-Cycle Assessment approach to the entire Product stage from raw material through manufacturing (A1-A3))

Kompan A/S
 C.F. Tietgens Boulevard 32C
 DK-5220 Odense SØ
 Denmark



Verification of CO₂ calculation of: Freestanding play equipment



Data version no. 2023-10-05

The CO₂ calculation and data are in compliance with the principles of a carbon footprint impact according to the GHG protocol (Greenhouse Gas Protocol), Scope 3, cradle to gate related to all individual components in the product category: "Freestanding play equipment" represented by item no.: KSW92011-0910.

(Scope 3 emissions include emission sources in the upstream and downstream value chain).

Date: 30. October 2023 | Valid until: 30. October 2025

Verified by:

Julie Marie Vejsgaard Larsen, LCA & EPD Consultant

Verification based on report: Validation of CO₂ calculation of 9 categories of Kompan product line, version 1.0, prepared by: Bureau Veritas HSE, Denmark: Julie M. V. Larsen.

Publication date: 30. October 2023

By Bureau Veritas HSE
 www.bureauveritas.dk
 +45 7731 1000



Double Zipline, Sloped Space, 82 ft Long

M88101

* Max fall height | ** Total height | *** Safety surfacing area

* Max fall height | ** Total height

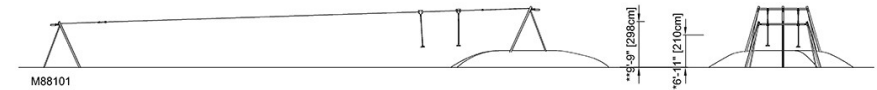
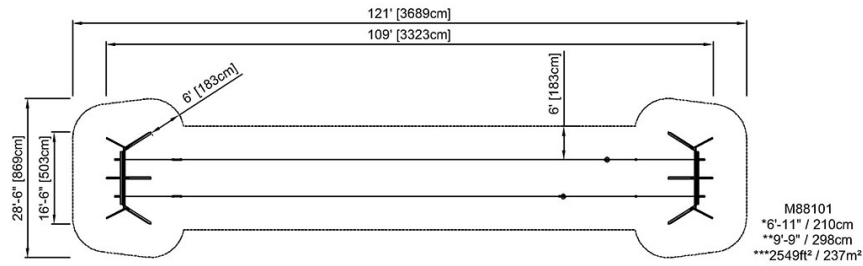

[Click to see TOP VIEW](#)

[Click to see SIDE VIEW](#)