

# Four-Mast Spacenet, Small

COR30304

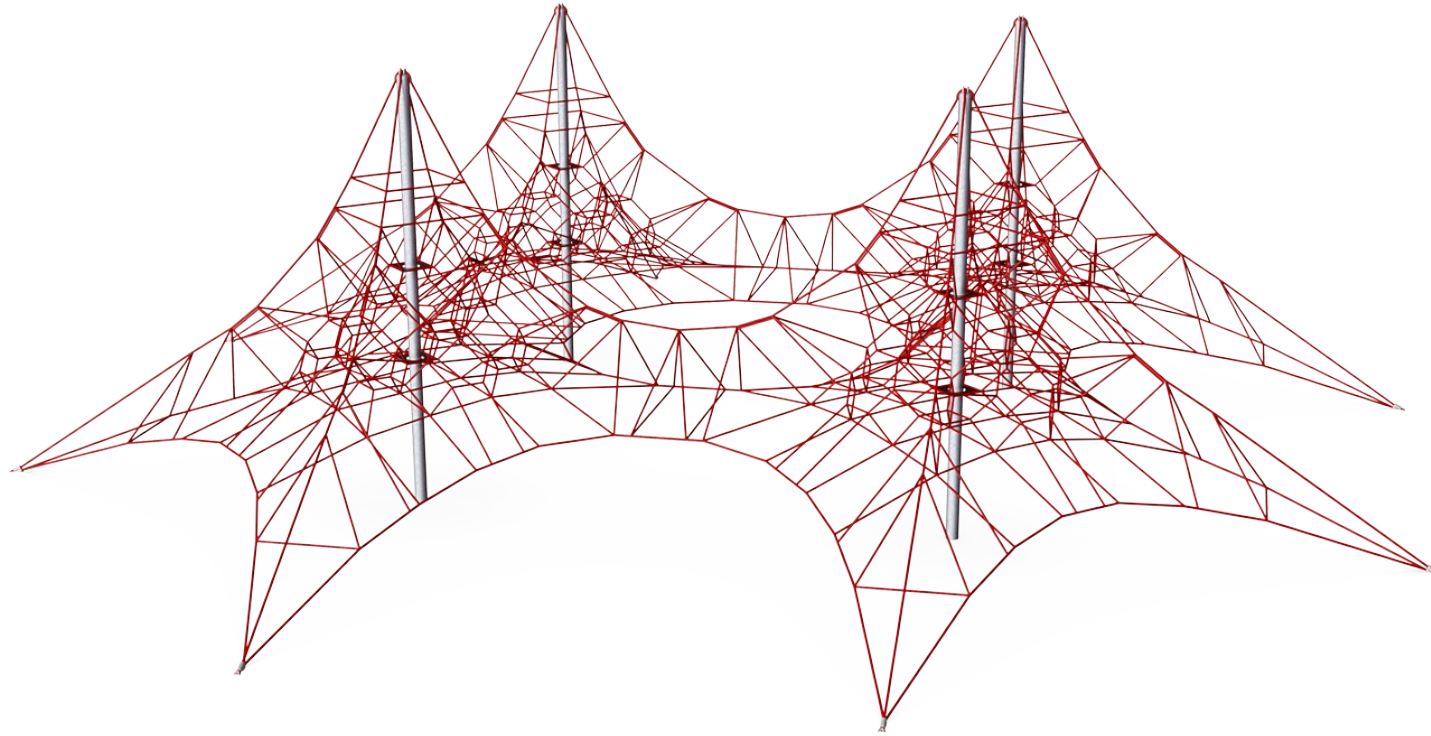

Item no. COR303041-1101	
<b>General Product Information</b>	
Dimensions LxWxH	1330x1330x393 cm
Age group	3+
Play capacity (users)	100
Colour options	

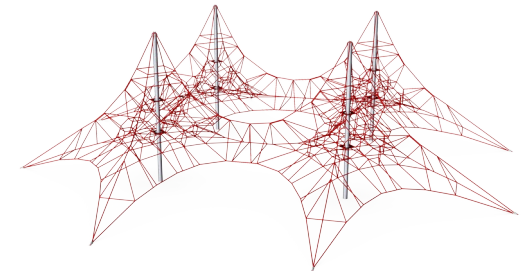
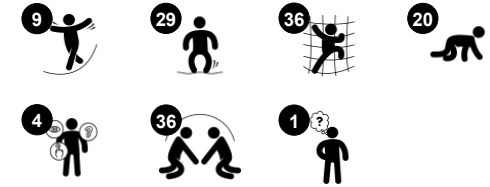

The 3.9m Four-Mast Spacenet stands out in any play area from its height and width. The feeling of achievement when having climbed to the top is phenomenal. The rope net is responsive to the movement of children climbing and crawling creating an element of thrill and making children want to come back again and again to have more of the bouncy,

climbing loops. Climbing the interdependent meshes of the transparent net is challenging and trains important motor skills such as balance and coordination. These motor skills are fundamental to sitting still or navigating traffic safely. Major muscle groups are used when children climb the Four-Mast Spacenet: arms push and pull, legs push, and the core

provides stability as the children cling onto the ropes. The Four-Mast Spacenet trains courage and self-regulation. These are important skills necessary for children's social-emotional development.

# Four-Mast Spacenet, Small

COR30304



## Mast

**Physical:** the slightly swaying mast stimulates children's muscles and motor skills when they hold tight climbing the net. **Social-Emotional:** children develop courage and self-regulation when climbing up high. This positively affects self-confidence.

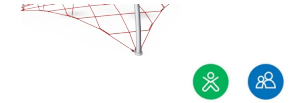
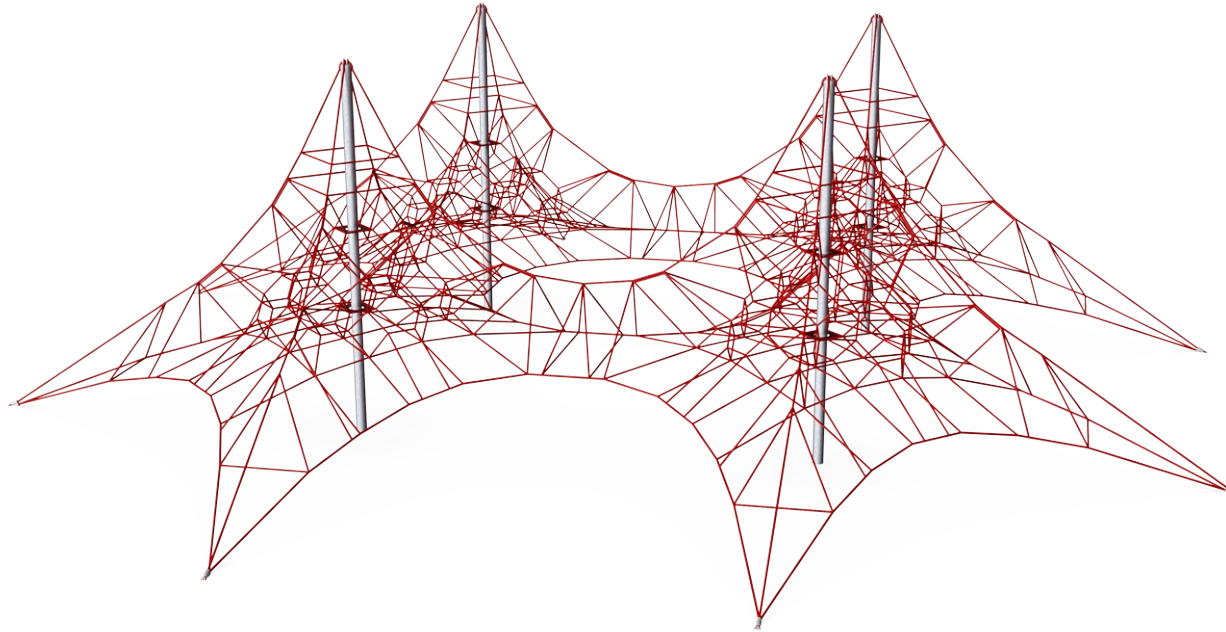

## Sturdy, lower rungs

**Physical:** the stiff bounce of the lower rung supports balance and coordination as well as strengthens bone density when jumping down. **Social-Emotional:** great meeting point allowing socialising.



## Highest rungs

**Physical:** spatial awareness is supported, arm muscles when holding tight. **Social-Emotional:** children develop courage, self-confidence, consideration and turn-taking, all important life skills.

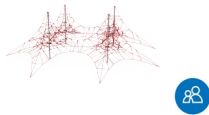

## Transparency

**Social-Emotional:** the transparency makes cooperation and communication possible, which are essential life skills for children to learn.

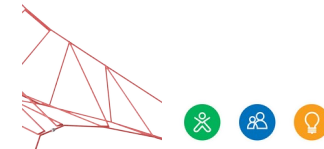

## Bouncy net meshes

**Physical:** agility, balance and coordination as well as spatial awareness are supported when bouncing, climbing and sitting in the net. **Social-Emotional:** the bouncing, swaying net appeals to empathy and cooperation. **Cognitive:** physical memory, logical thinking, concentration.



## Big meshes

**Physical:** the big meshes allow for climbing and crawling, supporting proprioception, cross coordination and spatial awareness. **Social-Emotional:** allow more children being seated together, sharing.

# Four-Mast Spacenet, Small

COR30304



Corocord ropes with 19mm+ diameter are known as a 'Hercules' rope type which is formed from galvanised six-stranded steel wires. Each strand is tightly wrapped with PES yarn, which is melted onto each individual strand. Ropes are highly wear-and vandalism-resistant and can be easily replaced on-site if needed.



Designed to allow the typical function of rope play structures to move Corocord 'S' clamps are used as universal connections in Corocord products. 8mm stainless steel rods with rounded edges are pressed around the ropes with a special hydraulic press, making them the ideal connector. Our clamps are safe, durable and vandalism-proof.



Safety is at the forefront of our designer's minds. That's why our spacenets' main bearing ropes are equipped with an additional safety feature. Should the main connections point fail, we have included an additional safety rope which prevents the structure from collapsing.



Corocord membranes consist of friction-proof rubberised material of conveyor belt quality with excellent UV resistance. Tested and compliant with REACH requirements for PAH. Embedded is a four-layered armouring made of woven polyester. The armouring and the two surface layers result in a total thickness of 7.5 mm.



In the centre of the net is the mast which is made of high-quality seamless steel and creates an oscillating support structure which is statically favourable and equalises the oscillations in the net. The masts are hot-dip galvanised as standard, with the design option of additional powder coating.



For installations using rubber surfacing the turnbuckle protectors are to be ordered separately.

Item no. COR303041-1101	
Installation Information	
Max. fall height	120 cm
Safety surfacing area	186.3 m <sup>2</sup>
Total installation time	31.3
Excavation volume	12.16 m <sup>3</sup>
Concrete volume	8.51 m <sup>3</sup>
Footing depth (standard)	110 cm
Shipment weight	1,174 kg
Anchoring options	In-ground ✓
Warranty Information	
Corocord (Hercules) Rope	10 years
Membrane	2 years
S-Clamps	10 years
Spare Parts Guarantee	10 years
Steel post HDG	Lifetime

**AS**  
**4685**  
compliant

# Sustainability Data

COR30304

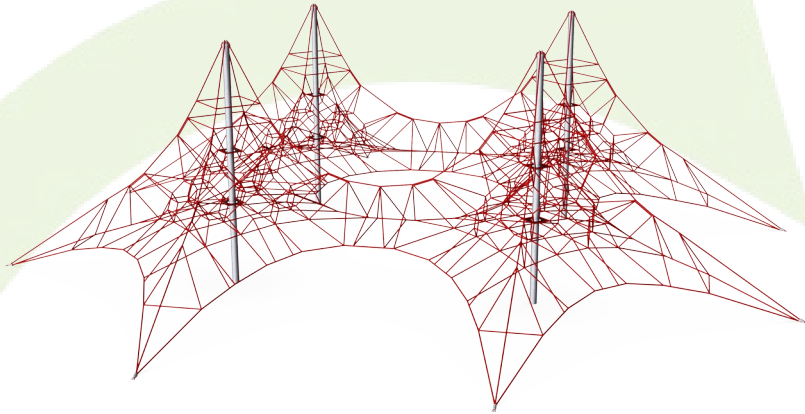

Cradle to Gate A1-A3	Total CO <sub>2</sub> emission	CO <sub>2</sub> e/kg	Recycled materials
	kg CO <sub>2</sub> e	kg CO <sub>2</sub> e/kg	%
<b>COR303041-1101</b>	3,079.10	3.16	54.75

The overall framework applied for these factors is the Environmental Product Declaration (EPD), which quantifies "environmental information on the life cycle of a product and enable comparisons between products fulfilling the same function" (ISO, 2006). This follows the structure and applies a Life-Cycle Assessment approach to the entire Product stage from raw material through manufacturing (A1-A3))

**Kompan A/S**  
 C.F. Tietgens Boulevard 32C  
 DK-5220 Odense SØ  
 Denmark



## Verification of CO<sub>2</sub> calculation of: Corocord



Data version no. 2023-10-05

The CO<sub>2</sub> calculation and data are in compliance with the principles of a carbon footprint impact according to the GHG protocol (Greenhouse Gas Protocol), Scope 3, cradle to gate related to all individual components in the product category: "Corocord" represented by item no.: COR314011-1101.

(Scope 3 emissions include emission sources in the upstream and downstream value chain).

**Date: 30. October 2023 | Valid until: 30. October 2025**

Verified by:

Julie Marie Vejsgaard Larsen, LCA & EPD Consultant

Verification based on report: Validation of CO<sub>2</sub> calculation of 9 categories of Kompan product line, version 1.0, prepared by: Bureau Veritas HSE, Denmark: Julie M. V. Larsen.

**Publication date: 30. October 2023**

By Bureau Veritas HSE  
 www.bureauveritas.dk  
 +45 7731 1000



# Four-Mast Spacenet, Small

COR30304

\* Max fall height | \*\* Total height | \*\*\* Safety surfacing area

\* Max fall height | \*\* Total height

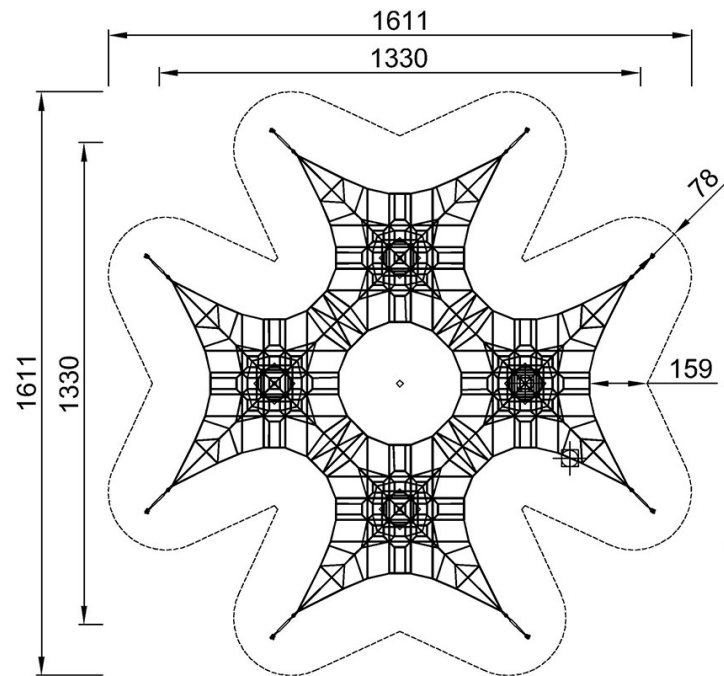

COR303041  
\*120cm  
\*\*393cm  
\*\*\*186.3m<sup>2</sup>

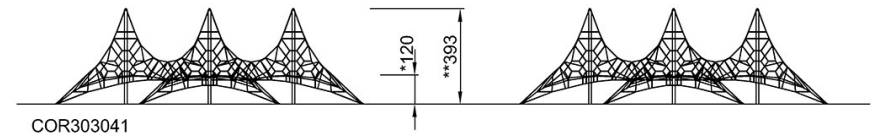

Attention! Foundation anchor blocks exceeds safety zone area. See installation instructions.

[Click to see TOP VIEW](#)

[Click to see SIDE VIEW](#)