



Double Cableway, flat ground, slide length 25m

NRO883



| | |
|------------------------------------|---|
| Item no. NRO883-1001 | |
| General Product Information | |
| Dimensions LxWxH | 3395x569x397 cm |
| Age group | 5 - 12 |
| Play capacity (users) | 2 |
| Colour options |   |



The Double Zipline is the ultimate social daredevil attraction. It will support social play again and again, with children racing each other to the end, comparing their speed as they go. And they will go, again and again. The reason for this solid holding power lies mainly in the immense thrill of gliding through the air. The feeling of weightlessness and swooshing

through the air trains spatial awareness as well as the child's understanding of gravity, space and speed. This is necessary for other skills such as managing street traffic safely. Social skills are developed as children diligently hand back the seat to the next user in line. The running and pulling involved in this trains the child's cardio as well as upper body muscles.

All in all, the large cableway is an asset of play that unites generations and abilities as there is some way for almost everyone to use it.

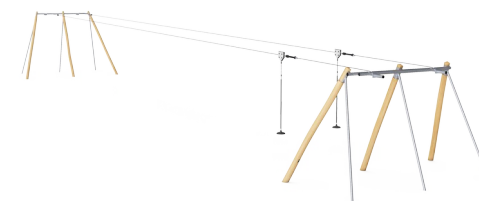

Double Cableway, flat ground, slide length 25m

NRO883



PUR covered rope

Physical: firm grip when spinning and hanging from arms. Arm muscles developed when holding tight.



Long line

Physical: the lengthy glide through the air adds to the thrill and trains spatial awareness, trunk stability and upper-body muscles. All this helps support the child's physical self esteem, making e.g. positive risk taking easier.



Dino seat

Physical: the three divisions and chains of the seat provide efficient handholds for both standing and seated swinging. **Social-Emotional:** the possibility of children swinging together, legs hanging down, trains cooperation, sequencing and turn-taking when swinging.



Double zipline

Social-Emotional: the possibility to glide with a companion or have friendly competitions supports turn taking and cooperation skills. **Cognitive:** the speed may differ between the two Ziplines. Figuring out the reason behind this (weight, speed, force etc.) trains logical thinking.

Double Cableway, flat ground, slide length 25m

NRO883



All Organic Robinia products by KOMPAN are made of Robinia wood from sustainable European sources. On request it can be supplied as FSC® Certified (FSC® C004450).



The steel surfaces are hot dip galvanised inside and outside with lead free zinc. The galvanisation has excellent corrosion resistance in outside environments and requires low maintenance.



The special designed seat is made of a stainless-steel insert covered with a soft layer of PUR rubber. The seat is impact tested to fulfill all global playground standards and the rope has an ergonomic handhold of a 100cm long moulded on PUR rubber handle.



The high-quality steel cable with a diameter of 12mm is designed for heavy usage of the cableway for many years. The starting point is indicated by a knob. At the stop point there is special designed spring device ensuring a softer stop of the puller.

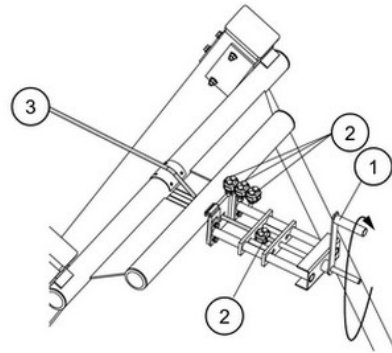

The steel cable 3 is tensioned by a special designed device. By turning the handle 1 the steel cable can be tensioned according to instruction in a safe way. After tensioning the cable is locked by three clamps 2. The tensioning device can also be used for adjustment during annual inspections.

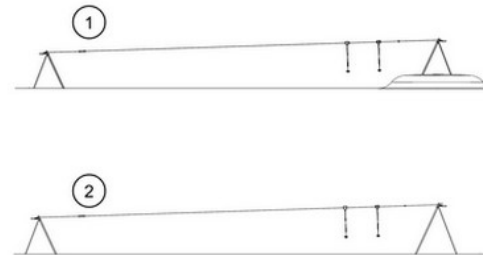

KOMPAN cableways are available for flat or natural sloped surroundings and for surface or in-ground installation. Further the cableways can be supplied with one or two cables for children to ride together in friendly competition. For flat surroundings a starting mound or platform is needed to use the cableway.

| Item no. NRO883-1001 | |
|--------------------------|----------------------|
| Installation Information | |
| Max. fall height | 100 cm |
| Safety surfacing area | 219.2 m ² |
| Total installation time | 20.8 |
| Excavation volume | 9.47 m ³ |
| Concrete volume | 4.03 m ³ |
| Footing depth (standard) | 100 cm |
| Shipment weight | 966 kg |
| Anchoring options | In-ground ✓ |
| Warranty Information | |
| Cable | 10 years |
| Movable parts | 2 years |
| PUR components | 10 years |
| Robinia wood | 15 years |
| Spare parts guaranteed | 10 years |

| Elevated activities 0 | Accessible elevated activities | Accessible ground level activities | Accessible ground level play types |
|-----------------------|--------------------------------|------------------------------------|------------------------------------|
| Present | 0 | 1 | 1 |
| Required | 0 | 1 | 1 |



Sustainability Data

NRO883

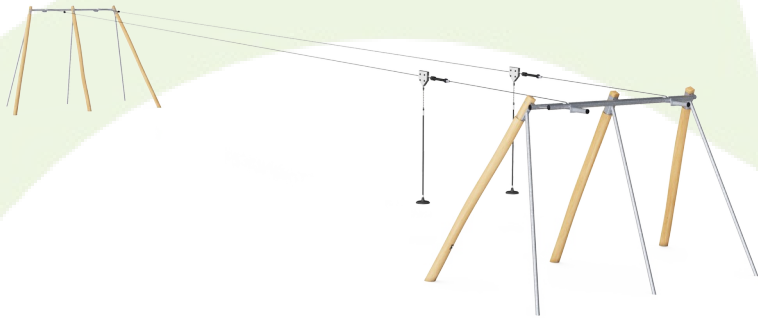

| Cradle to Gate A1-A3 | Total CO ₂ emission | CO ₂ e/kg | Recycled materials |
|----------------------|--------------------------------|-------------------------|--------------------|
| | kg CO ₂ e | kg CO ₂ e/kg | % |
| NRO883-1001 | 1,117.74 | 1.33 | 24.41 |

The overall framework applied for these factors is the Environmental Product Declaration (EPD), which quantifies "environmental information on the life cycle of a product and enable comparisons between products fulfilling the same function" (ISO, 2006). This follows the structure and applies a Life-Cycle Assessment approach to the entire Product stage from raw material through manufacturing (A1-A3))

Kompan A/S
 C.F. Tietgens Boulevard 32C
 DK-5220 Odense SØ
 Denmark



Verification of CO₂ calculation of: Nature play



Data version no. 2023-10-05

The CO₂ calculation and data are in compliance with the principles of a carbon footprint impact according to the GHG protocol (Greenhouse Gas Protocol), Scope 3, cradle to gate related to all individual components in the product category: "Nature play" represented by item no.: NRO409-0621.

(Scope 3 emissions include emission sources in the upstream and downstream value chain).

Date: 30. October 2023 | Valid until: 30. October 2025

Verified by:

Julie Marie Vejsgaard Larsen, LCA & EPD Consultant

Verification based on report: Validation of CO₂ calculation of 9 categories of Kompan product line, version 1.0, prepared by: Bureau Veritas HSE, Denmark: Julie M. V. Larsen.

Publication date: 30. October 2023

By Bureau Veritas HSE
 www.bureauveritas.dk
 +45 7731 1000



Double Cableway, flat ground, slide length 25m

NRO883

* Max fall height | ** Total height | *** Safety surfacing area

* Max fall height | ** Total height

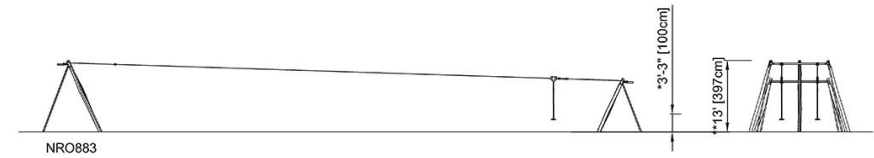
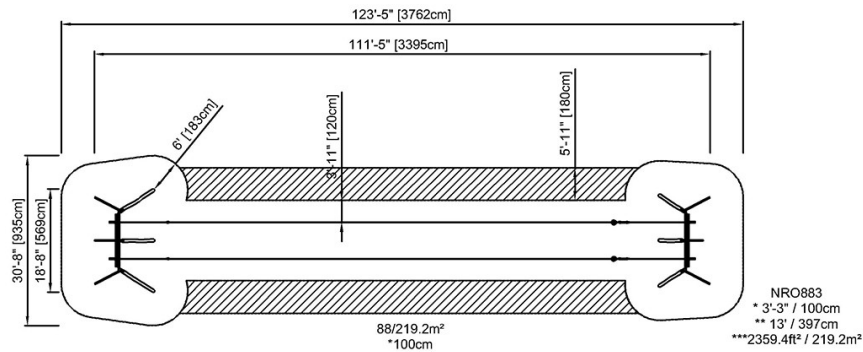

[Click to see TOP VIEW](#)

[Click to see SIDE VIEW](#)