

# Tractor with Slide

PCM51021



Item no. PCM51021-0903

## General Product Information

Dimensions LxWxH	549x297x293 cm
Age group	2+
Play capacity (users)	18
Colour options	  

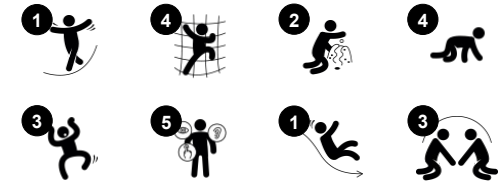

The Tractor is an appealing attractor for dramatic and physical play for younger children. The rich variety of climb, crawl and slide activities attracts and ensures physical activity that trains important motor skills and major muscles. On the platform, a gear shift, a steering wheel and side mirrors add to the feeling of driving a beastly big Tractor. On

ground level, multiple varied climbs up and crawls through holes to under the platform ensures ample encouragement to climb and crawl. This trains cross-body coordination which builds body confidence and ultimately stimulate the cross-modal perception which adds to supports to for instance reading skills. Dramatic play is the favorite play type for

younger children. Apart from building an understanding of the world, dramatic play also trains language and communication skills intensely. In the case of the Tractor, storytelling themes of farming, driving and building will be put to play.

# Tractor with Slide

PCM51021



## Gear shift

**Social-Emotional:** cooperation, turn-taking, sharing. **Cognitive:** suggests a theme and supports dramatic play, which stimulates languages skills.



## Side mirror

**Cognitive:** understanding of individuality and self expression. Stimulates dramatic play and thus language and communication development.



## Turning wheel

**Cognitive:** the manipulative item stimulates cause and effect understanding.



## Slide

**Physical:** sliding develops spatial awareness and a sense of balance. Furthermore, the core muscles are trained when sitting upright going down. **Social-Emotional:** empathy stimulated by turn-taking. **Cognitive:** young children develop their understanding of space, speed and distances when sliding down quickly.



## Pipe ladder

**Physical:** cross coordination and eye-hand coordination are supported when children climb the ladder. The climbing also supports leg and arm muscles. **Social-Emotional:** learning about turn taking and cooperation.



## Crawl-through hole

**Physical:** the hole allows for climbing and crawling through, developing cross coordination, proprioception and spatial awareness. **Social-Emotional:** cooperation and turn-taking when passing one another. **Cognitive:** understanding space, shape and measures when seeing if the body can fit through the hole.



## Rock climber

**Physical:** supports cross coordination and leg, arm and hand strength. **Social-Emotional:** the inclination makes climbing feel secure, especially for younger children.

# Tractor with Slide

PCM51021



Panels of 19mm EcoCore™. EcoCore™ is a highly durable, eco friendly material, which is not only recyclable after use, but also consists of material produced from +95% recycled post consumer material from food packing waste.



Main posts with hot dip galvanised steel footing are pre-galvanised inside and outside with powder coated top finish.



All decks are supported by unique designed low-carbon aluminum profiles with multiple attachment options. The grey colored molded decks are made of 75% post-consumer waste PP material with a non-skid pattern and texture surface.

Item no. PCM51021-0903

### Installation Information

Max. fall height	118 cm
Safety surfacing area	37.1 m <sup>2</sup>
Total installation time	28.9
Excavation volume	1.04 m <sup>3</sup>
Concrete volume	0.05 m <sup>3</sup>
Footing depth (standard)	90 cm
Shipment weight	916 kg
Anchoring options	In-ground ✓ Surface ✓

### Warranty Information

EcoCore HDPE	Lifetime
Hollow PE parts	10 years
Post	10 years
PP Decks	10 years
Spare parts guaranteed	10 years

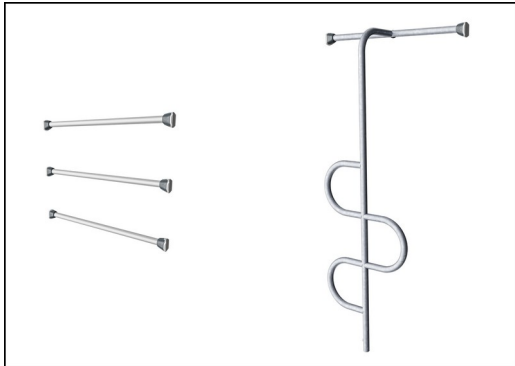

The steel surfaces are hot dip galvanized inside and outside with lead free zinc. The galvanization has excellent corrosion resistance in outside environments and requires low maintenance.



The slides are available in either molded PE made from 33% recycled post-consumer materials in different colors or in full AISI304 stainless steel with a thickness of 2mm.



Gear shift is made of PP. PP has good wearing and impact resistance.



# Sustainability Data

PCM51021



Cradle to Gate A1-A3	Total CO <sub>2</sub> emission	CO <sub>2</sub> e/kg	Recycled materials
	kg CO <sub>2</sub> e	kg CO <sub>2</sub> e/kg	%
<b>PCM51021-0903</b>	1,160.78	1.77	68.82

The overall framework applied for these factors is the Environmental Product Declaration (EPD), which quantifies "environmental information on the life cycle of a product and enable comparisons between products fulfilling the same function" (ISO, 2006). This follows the structure and applies a Life-Cycle Assessment approach to the entire Product stage from raw material through manufacturing (A1-A3))

**Kompan A/S**  
 C.F. Tietgens Boulevard 32C  
 DK-5220 Odense SØ  
 Denmark



## Verification of CO<sub>2</sub> calculation of: Play systems



Data version no. 2023-10-05

The CO<sub>2</sub> calculation and data are in compliance with the principles of a carbon footprint impact according to the GHG protocol (Greenhouse Gas Protocol), Scope 3, cradle to gate related to all individual components in the product category: "Play systems" represented by item no.: PCM200321-0950.

(Scope 3 emissions include emission sources in the upstream and downstream value chain).

**Date: 30. October 2023 | Valid until: 30. October 2025**

Verified by:

Julie Marie Vejsgaard Larsen, LCA & EPD Consultant

Verification based on report: Validation of CO<sub>2</sub> calculation of 9 categories of Kompan product line, version 1.0, prepared by: Bureau Veritas HSE, Denmark: Julie M. V. Larsen.

**Publication date: 30. October 2023**

By Bureau Veritas HSE  
 www.bureauveritas.dk  
 +45 7731 1000



# Tractor with Slide

PCM51021

\* Max fall height | \*\* Total height | \*\*\* Safety surfacing area

\* Max fall height | \*\* Total height

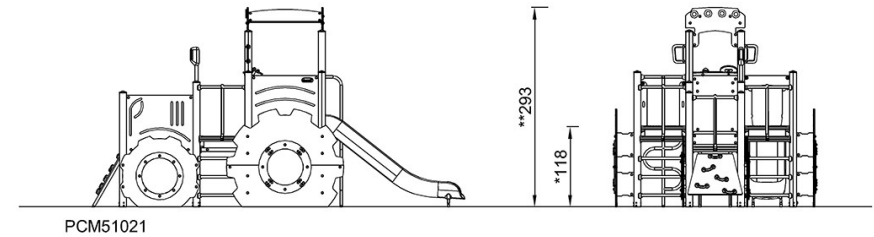
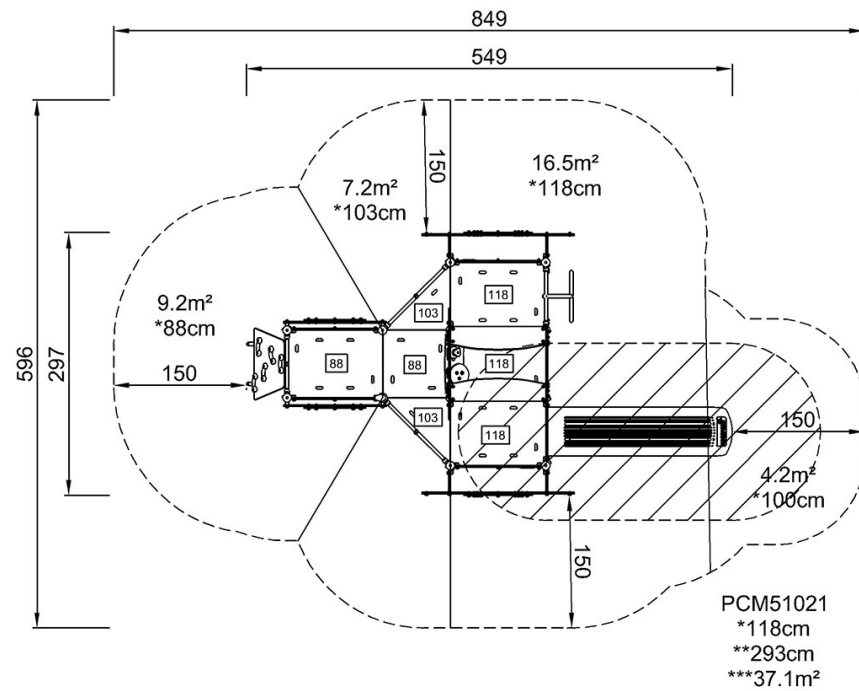

[Click to see TOP VIEW](#)

[Click to see SIDE VIEW](#)