

**433

*224

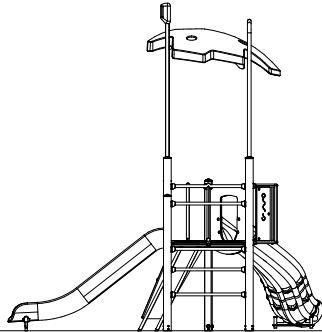

PCE112122
1:100