

Hideaway Tree

PCM52821

KOMPAN
Let's play



The Hideaway Tree offers a richness of play events which attract children to play over and over. The beautiful tree offers varied climbing, dramatic and social play options: children can access the platform with play panels and treehouse either by taking the stairs or the climbing wall. The platform offers numerous tactile details in panels, which train young

children's logical thinking skills and inspire dramatic play. Climbing up here is a favourite play activity. Climbing supports children's cross-coordination skills and builds fundamental movement skills that positively affect cross-modal perception and learning. Gliding down the fireman's pole is a great thrill, and it trains children's sense of balance and

space, as well as their muscles. Under the play platform a hammock invites socialising and offers a gently swaying break from climbing, for individual play or social play.

产品编号 PCM52821-0901

产品信息概览

长宽高尺寸	526x437x420 cm
适用年龄段	2+
容纳人数	21
颜色选择	●

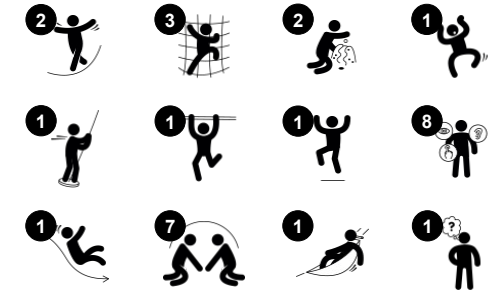

Hideaway Tree

PCM52821



摇摆座椅

身体素质：摇摆时的协调性和平衡感。**社交情感：**和朋友见面，轻轻地前后推朋友，轮流玩耍。**认知能力：**让幼儿理解因果关系。



游戏主题

认知能力：鼓励戏剧游戏，刺激儿童语言和交流能力的发展。



滑梯

身体素质：玩滑梯可以培养空间感和平衡感。此外，在直立向下坐时，核心肌肉也能得到锻炼。**社交情感：**轮流玩耍时可激发同理心。**认知能力：**幼儿在快速滑下时可训练对空间、速度和距离的理解。

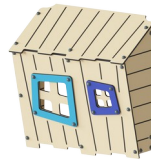

Tree House

社交情感： offers a great meeting point to be together with friends. The height adds a feeling of achievement to meet friends here.



Bats and Spider panel

社交情感： invites cooperation due to the two-sidedness. **认知能力：** children can leave their mark, placing the bats in different positions. **认知能力：** the tangible theme stimulates language and communication skills.

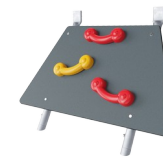

攀爬墙

身体素质： 训练交叉协调能力以及腿部、手臂和手部力量。**社交情感：** 对年幼的孩子来说，绳网的倾斜度让攀爬更具安全感。



Fireman's pole

身体素质： 当下降时，协调得到支持，同时也锻炼了手臂和核心肌肉。着地时会增强骨密度，这对于儿童早期生活中的骨骼建设至关重要。**社交情感：** 训练轮流意识和风险意识。**认知能力：** 幼儿在快速滑下时可训练对空间、速度和距离的理解。

Hideaway Tree

PCM52821



19 毫米 EcoCore™ 面板。EcoCore™ 是一种高度耐用、环保的材料，不仅在使用后可回收利用，而且还包含由 100 % 食品包装可循环材料制成的芯。



Main posts with hot dip galvanized steel footing are available in different materials: Pre-galvanized inside and outside with powder coated top finish steel posts. Lead free aluminum with color anodized top finish. TexMade posts of 95% post-consumer recycled PE and textile waste.



所有平台底板均由独特设计的低碳铝型材支撑，并具有多种加配选择。灰色模制平台底板由 75% 消费后的海洋可循环 PP 材料制成，具有防滑图案和表面纹理。

产品编号 PCM52821-0901

安装信息

最大跌落高度	118 cm
安全面积	34.9 m ²
安装总时长	34.1
开挖量	0.74 m ³
混凝土使用量	0.02 m ³
标准入地深度	90 cm
运输重量	1,348 kg
固定选项	地表 ✓ 入地 ✓

质保信息

EcoCore HDPE	终身质保
立柱	10 年
PP 板	10 年
承保零部件	10 年
不锈钢零件	终身质保

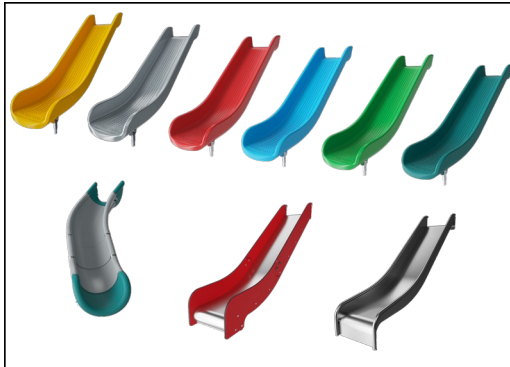

载玻片可以选择六种不同的颜色和树形材料：直的或弯曲的一体式成型 PE 载玻片。结合 EcoCore™ 侧面和不锈钢。全不锈钢一体式设计，更多防破坏解决方案。

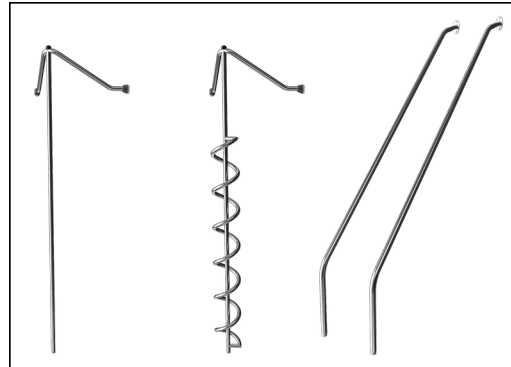

不锈钢游戏活动部件由优质不锈钢制成。在制造后使用酸洗工艺对钢进行清洁，以确保光滑和清洁的顺滑表面。



KOMPAN 环保系列产品采用终极环保材料设计，具有最低可能性的二氧化碳排放当量系数。TexMade 立柱，100% 消费后的海洋可循环材料制成的 EcoCore™ 面板和模制 PP 平台底板。

Sustainability Data

PCM52821



从原材料到成品

CO₂ 排放总量

kg CO₂e

CO₂ 排放量 / 千克

kg CO₂e/kg

回收的原料

%

PCM52821-0901

1,396.82

1.46

75.15

这些因素采用的总体框架为环保产品声明 (EPD), 该声明可量化“产品生命周期的环保信息, 并对相同功能的产品进行对比” (ISO, 2006)。在遵循该框架的同时, 对从原材料到制造的整个产品阶段 (A1-A3) 应用生命周期评估法。

Kompan A/S

C.F. Tietgens Boulevard 32C
DK-5220 Odense SØ
Denmark



Verification of CO₂ calculation of: Play systems



Data version no. 2023-10-05

The CO₂ calculation and data are in compliance with the principles of a carbon footprint impact according to the GHG protocol (Greenhouse Gas Protocol), Scope 3, cradle to gate related to all individual components in the product category: "Play systems" represented by item no.: PCM200321-0950.

(Scope 3 emissions include emission sources in the upstream and downstream value chain).

Date: 30. October 2023 | Valid until: 30. October 2025

Verified by:

Julie Marie Vejsgaard Larsen, LCA & EPD Consultant

Verification based on report: Validation of CO₂ calculation of 9 categories of Kompan product line, version 1.0, prepared by: Bureau Veritas HSE, Denmark: Julie M. V. Larsen.

Publication date: 30. October 2023

By Bureau Veritas HSE
www.bureauveritas.dk
+45 7731 1000



Hideaway Tree

PCM52821

最大跌落高度 | 总高度 | 安全区域

最大跌落高度 | 总高度

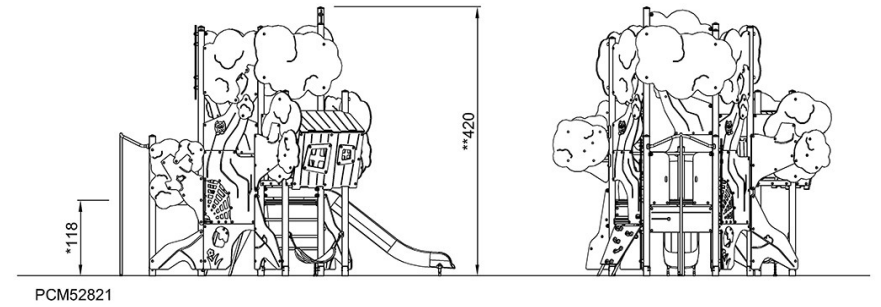
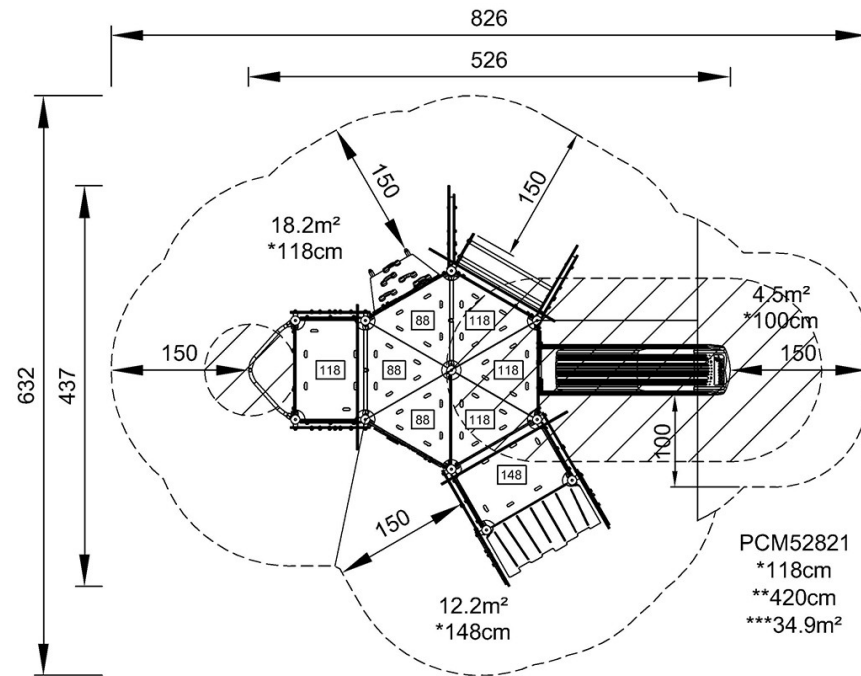

[点击查看俯视图](#)

[点击查看侧面图](#)