

Home & Rescue

MSC6401

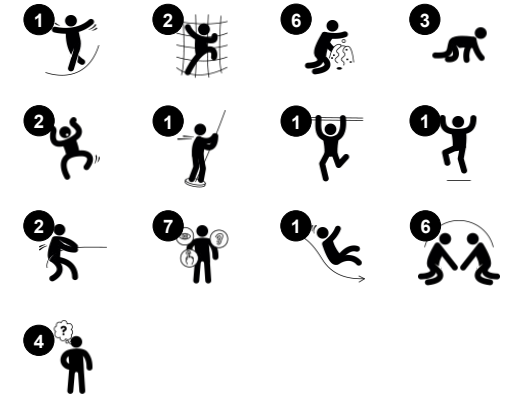

Item no. MSC640100-3717P	
General Product Information	
Dimensions LxWxH	348x425x285 cm
Age group	2+
Play capacity (users)	17
Colour options	●



The Home & Rescue themes appeal to children's urge for dramatic play stories. Thanks to the two-sided panels, themes, and varied accesses: curved and inclined, the Home & Rescue challenge a wide user group. The curved climbing wall, crawl through tyre, and inclined climbing net, train motor skills such as cross-coordination in their own fun

ways. This influences the brain's ability to read and write and builds up body confidence, making children more secure in moving through the world. The Home & Rescue can be played with on all sides. From the upper-level, tactile details encourage communication with the outside and the under-deck den invites a break with friends. Here children meet, greet and

play, making friends for life.

Home & Rescue

MSC6401



Fireman's pole

Physical: supports coordination, arm and core muscles. Landing strengthens bone density. **Social-Emotional:** turn-taking and risk-taking. **Cognitive:** young children develop their understanding of space, speed and distances when gliding down fast.



Crawl-through hole

Physical: the hole allows for climbing and crawling through, developing cross coordination, proprioception and spatial awareness. **Social-Emotional:** cooperation and turn-taking when passing one another. **Cognitive:** understanding space, shape and measures when seeing if the body can fit through the hole.

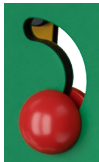

Play sphere

Social-Emotional: can be played from both sides, encouraging cooperation. **Cognitive:** cause and effect understanding. **Creative:** leave a mark and place the spheres at different positions.



Curved climbing wall

Physical: children develop their cross-body coordination, proprioception and leg, arm and hand strength. Climbing on a curved surface challenges muscles.



Climbing net

Physical: hand-eye coordination, cross coordination and proprioception are trained. These are fundamental for judging the body in time and space.



Den

Physical: crawling through the possible openings trains spatial awareness. **Social-Emotional:** the enclosed space invites social play for two or three children.



Slide

Physical: develops spatial awareness, sense of balance and trains core muscles when sitting upright going down. **Social-Emotional:** empathy stimulated by turn-taking. **Cognitive:** young children develop their understanding of space, speed and distances when sliding down.

Home & Rescue

MSC6401



Panels of 19mm EcoCore™. EcoCore™ is a highly durable, eco-friendly material, which is not only recyclable after use but also consists of a core produced from 100% recycled material.

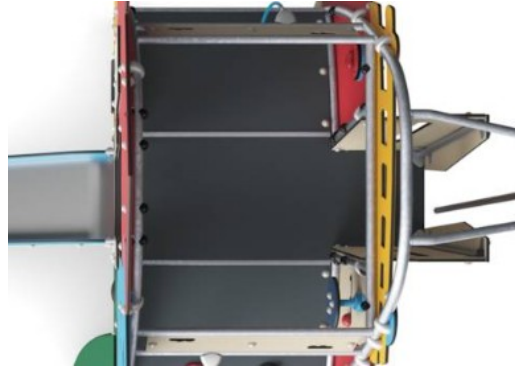

All floors are made from high-pressure laminate HPL with a thickness 17.8mm and non-skid surface texture. KOMPAN HPL is high wearing and suitable for all climates.

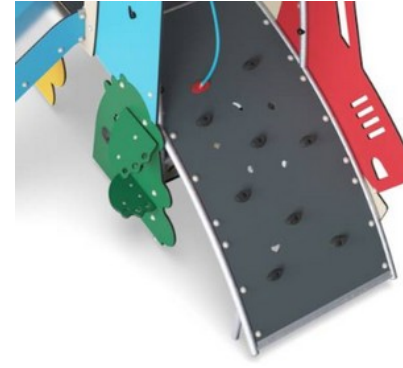

The curved climbing wall is made of Ekogrip® panel that consists of a 15mm thick PE base with 3 mm top-layer of soft rubber with a non-skid effect.

Item no. MSC640100-3717P

Installation Information

Max. fall height	133 cm
Safety surfacing area	32.0 m ²
Total installation time	23.3
Excavation volume	0.83 m ³
Concrete volume	0.00 m ³
Footing depth (standard)	90 cm
Shipment weight	723 kg
Anchoring options	In-ground ✓ Surface ✓

Warranty Information

EcoCore HDPE	Lifetime
Galvanised Steel	Lifetime
HPL Decks	15 years
Ropes & Nets	10 years
Spare Parts Guarantee	10 years



The slide is made of combined EcoCore™ sides and stainless steel slide bed t=2mm.

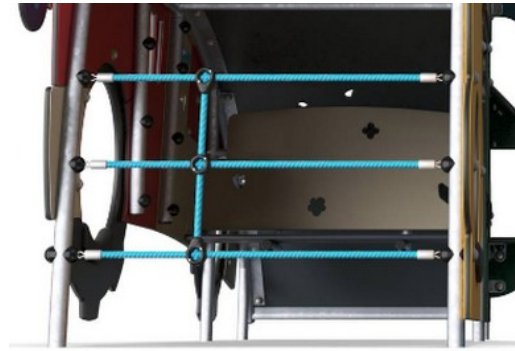

Climbing nets are made of UV-stabilised PP rope with inner steel cable reinforcement. The rope is induction treated to obtain maximum fixation between steel and rope, which provides excellent wear and tear resistance. All rope connectors are made of 100% recyclable PA material.



The steel surfaces are hot-dip galvanised inside and outside with lead-free zinc. The galvanisation has excellent corrosion resistance in outside environments and requires low maintenance.



Sustainability Data

MSC6401



Cradle to Gate A1-A3	Total CO ₂ emission	CO ₂ e/kg	Recycled materials
	kg CO ₂ e	kg CO ₂ e/kg	%
MSC640100-3717P	1,232.53	2.23	59.11

The overall framework applied for these factors is the Environmental Product Declaration (EPD), which quantifies "environmental information on the life cycle of a product and enable comparisons between products fulfilling the same function" (ISO, 2006). This follows the structure and applies a Life-Cycle Assessment approach to the entire Product stage from raw material through manufacturing (A1-A3))

Kompan A/S
 C.F. Tietgens Boulevard 32C
 DK-5220 Odense SØ
 Denmark



Verification of CO₂ calculation of: Themed play systems



Data version no. 2023-10-05

The CO₂ calculation and data are in compliance with the principles of a carbon footprint impact according to the GHG protocol (Greenhouse Gas Protocol), Scope 3, cradle to gate related to all individual components in the product category: "Themed play systems" represented by item no.: MSC641100-3717P.

(Scope 3 emissions include emission sources in the upstream and downstream value chain).

Date: 30. October 2023 | Valid until: 30. October 2025

Verified by:

Julie Marie Vejsgaard Larsen, LCA & EPD Consultant

Verification based on report: Validation of CO₂ calculation of 9 categories of Kompan product line, version 1.0, prepared by: Bureau Veritas HSE, Denmark: Julie M. V. Larsen.

Publication date: 30. October 2023

By Bureau Veritas HSE
 www.bureauveritas.dk
 +45 7731 1000



Home & Rescue

MSC6401

* Max fall height | ** Total height | *** Safety surfacing area

* Max fall height | ** Total height

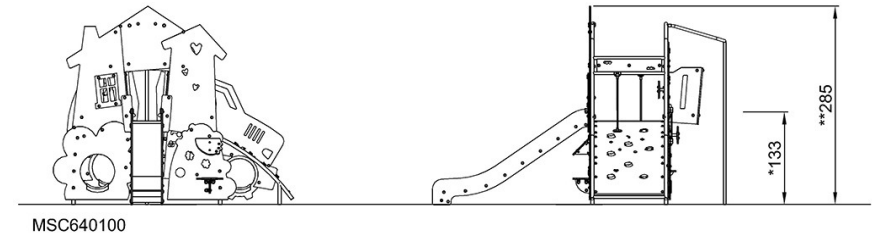
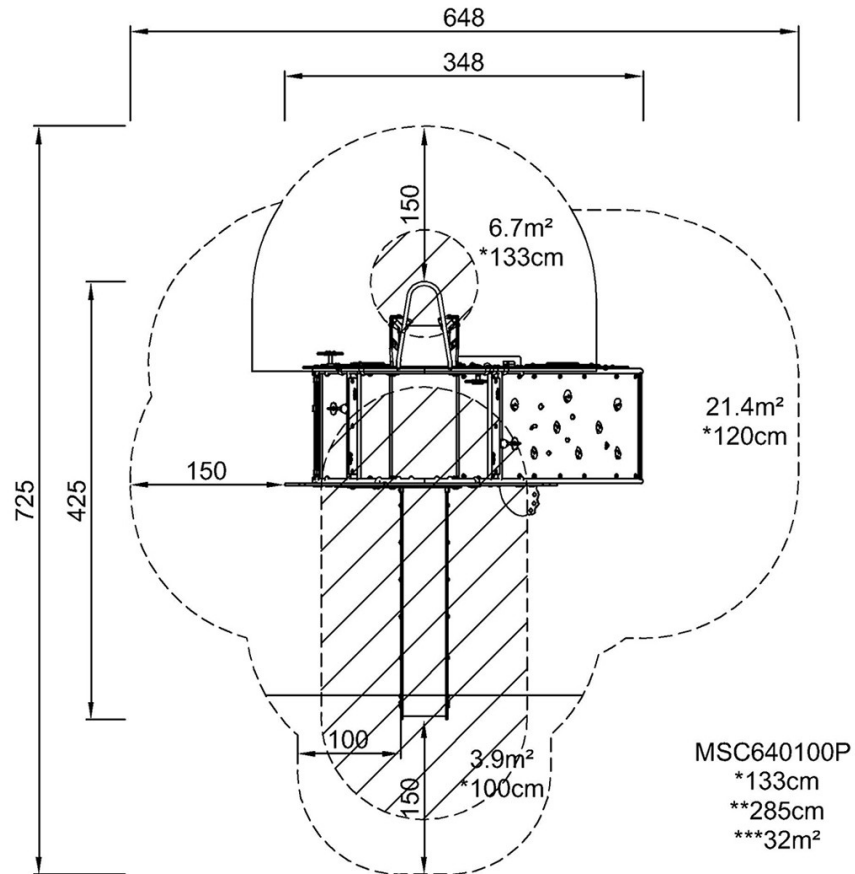

[Click to see TOP VIEW](#)

[Click to see SIDE VIEW](#)