

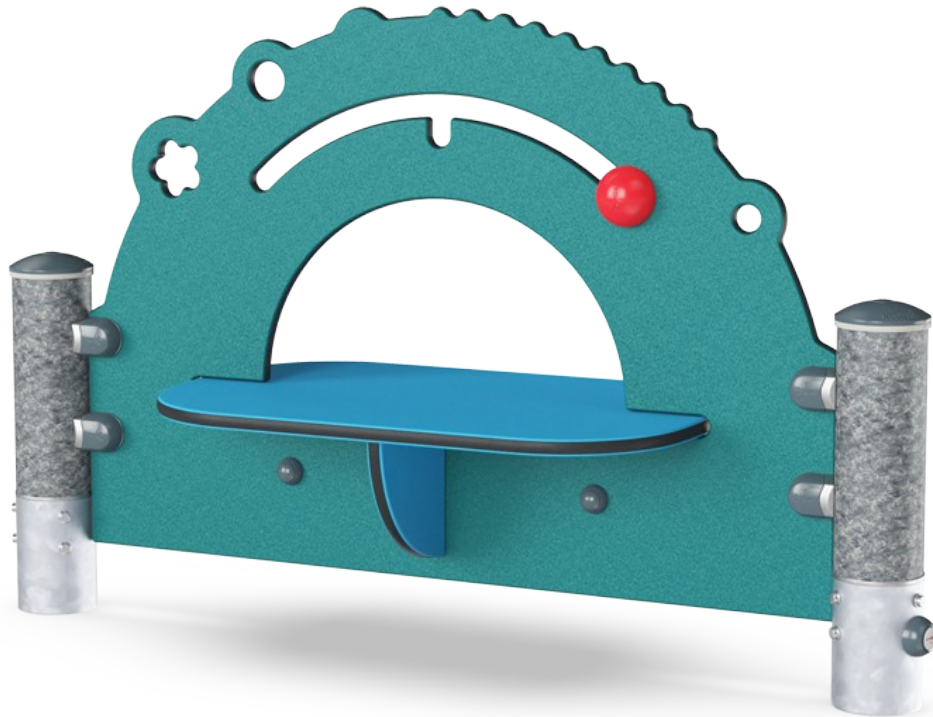

# Talk & Tumble Counter

PCM000121



Item no. PCM000121-0650	
<b>General Product Information</b>	
Dimensions LxWxH	121x42x77 cm
Age group	6m+
Play capacity (users)	4
Colour options	



The Play Counter is full of WOW for young children: Loaded with play activities that will keep them playing. The scale is perfectly suited to the play of young children. The height of the openings and panels support e.g. the first steps, as the infant gets good grip support thanks to the holes and openings. The desk with opening supports social games such as

peek-a-boo. These games stimulate children socially as well as cognitively as they begin to understand that people and objects still exist when out of sight. The sphere is bright and runs in a groove. When the young child uses it there is an understanding of cause and effect. As the sphere moves on both sides, children will discover theory of mind and that others

may have other intentions than they do. This encourages cooperation and taking turns.

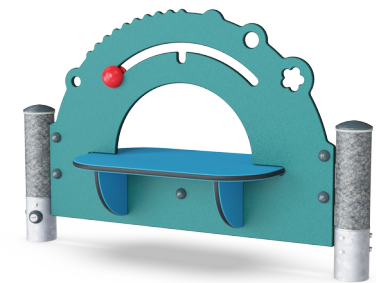

# Talk & Tumble Counter

PCM000121



## Play sphere

**Social-Emotional:** can be played from both sides, encouraging cooperation. **Cognitive:** cause and effect understanding. **Creative:** leave a mark and place the spheres at different positions.

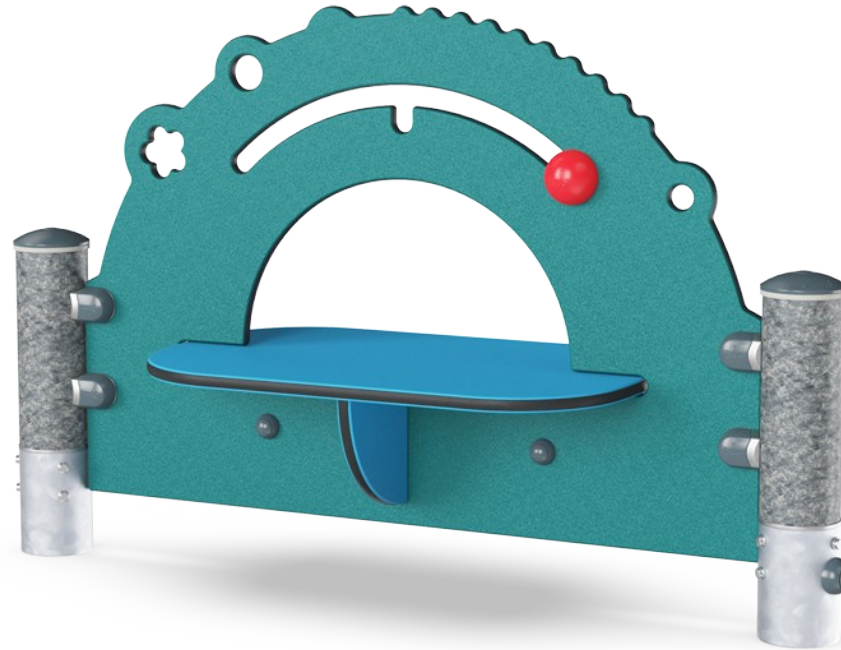

## Desk

**Social-Emotional:** fine meeting place and a space creator. Sharing and cooperation from both sides create a social scenario that supports communication and cooperation.



## Two sides

**Social-Emotional:** invites cooperation and communication. The low height and the transparency of the panel makes interaction possible between the two sides.

# Talk & Tumble Counter

PCM000121

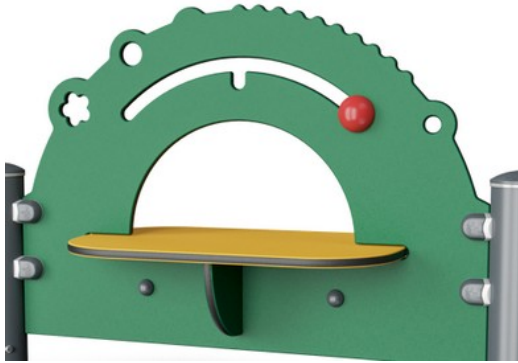

Panels of 19mm EcoCore™. EcoCore™ is a highly durable, eco friendly material, which is not only recyclable after use, but also consists of material produced from +95% recycled post consumer material from food packing waste.



Main posts with hot dip galvanized steel footing are available in different materials: Pressure impregnated pine wood posts. Pre-galvanized inside and outside with powder coated top finish steel posts. Lead free aluminum with color anodized top finish. Greenline TexMade posts of 95% post-consumer recycled PE and textile waste.

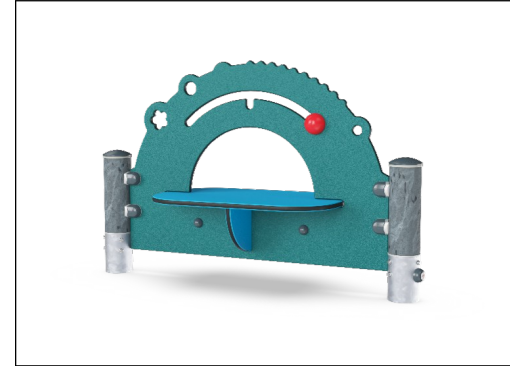

KOMPAN GreenLine versions are designed with ultimate environmentally friendly materials with lowest possible CO2e emission factor such as EcoCore™ panels of +95% post consumer recycled ocean waste.

Item no. PCM000121-0650

### Installation Information

Max. fall height	0 cm
Safety surfacing area	11.3 m <sup>2</sup>
Total installation time	2.8
Excavation volume	0.05 m <sup>3</sup>
Concrete volume	0.00 m <sup>3</sup>
Footing depth (standard)	60 cm
Shipment weight	42 kg
Anchoring options	In-ground ✓ Surface ✓

### Warranty Information

EcoCore HDPE	Lifetime
Post	10 years
Spare parts guaranteed	10 years



# Sustainability Data

PCM000121

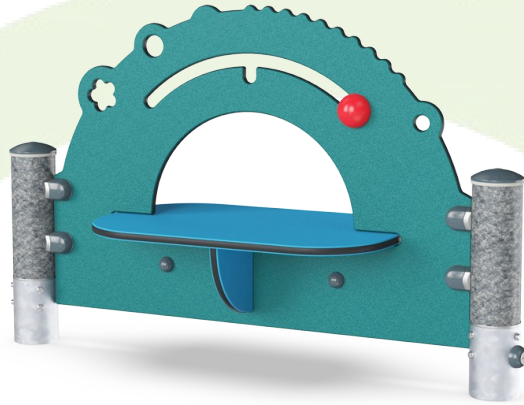

Cradle to Gate A1-A3	Total CO <sub>2</sub> emission	CO <sub>2</sub> e/kg	Recycled materials
	kg CO <sub>2</sub> e	kg CO <sub>2</sub> e/kg	%
PCM000121-0650	38.57	1.30	80.60
PCM000121-0601	46.45	1.69	73.89

The overall framework applied for these factors is the Environmental Product Declaration (EPD), which quantifies "environmental information on the life cycle of a product and enable comparisons between products fulfilling the same function" (ISO, 2006). This follows the structure and applies a Life-Cycle Assessment approach to the entire Product stage from raw material through manufacturing (A1-A3))

**Kompan A/S**  
 C.F. Tietgens Boulevard 32C  
 DK-5220 Odense SØ  
 Denmark



## Verification of CO<sub>2</sub> calculation of: Themed play systems



Data version no. 2023-10-05

The CO<sub>2</sub> calculation and data are in compliance with the principles of a carbon footprint impact according to the GHG protocol (Greenhouse Gas Protocol), Scope 3, cradle to gate related to all individual components in the product category: "Themed play systems" represented by item no.: MSC641100-3717P.

(Scope 3 emissions include emission sources in the upstream and downstream value chain).

**Date: 30. October 2023 | Valid until: 30. October 2025**

Verified by:

Julie Marie Vejsgaard Larsen, LCA & EPD Consultant

Verification based on report: Validation of CO<sub>2</sub> calculation of 9 categories of Kompan product line, version 1.0, prepared by: Bureau Veritas HSE, Denmark: Julie M. V. Larsen.

**Publication date: 30. October 2023**

By Bureau Veritas HSE  
 www.bureauveritas.dk  
 +45 7731 1000



# Talk & Tumble Counter

PCM000121

\* Max fall height | \*\* Total height | \*\*\* Safety surfacing area

\* Max fall height | \*\* Total height

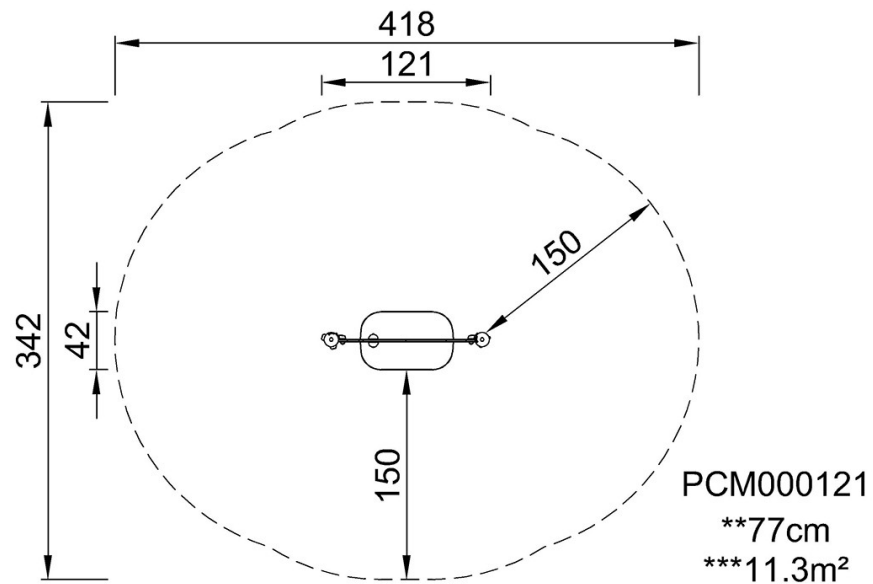

PCM000121

[Click to see TOP VIEW](#)

[Click to see SIDE VIEW](#)