

Howler Trail

CRP251101

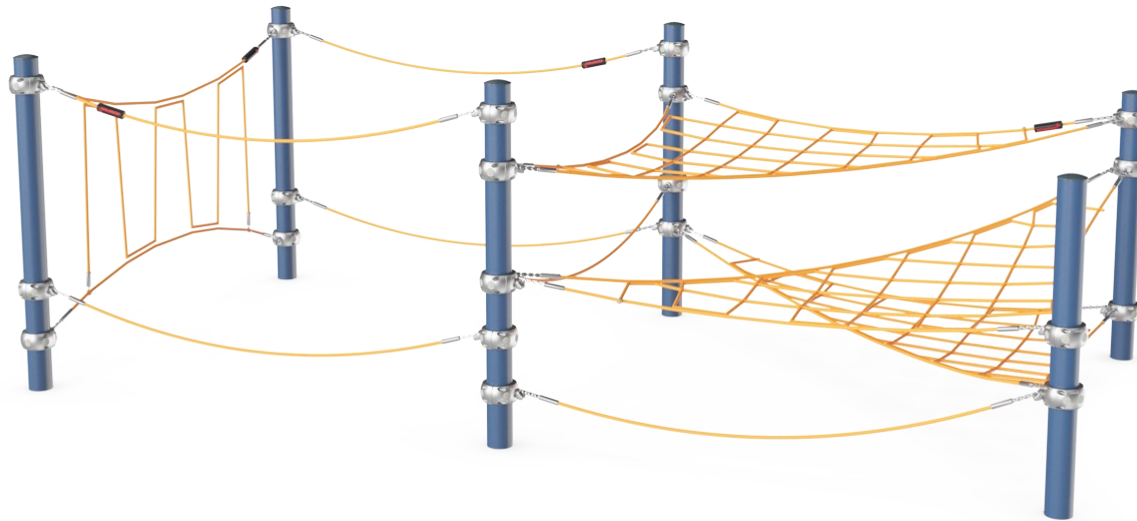

Item no. CRP251101-0903

General Product Information

Dimensions LxWxH	606x314x197 cm
Age group	6+
Play capacity (users)	24
Colour options	

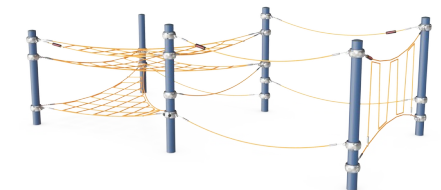
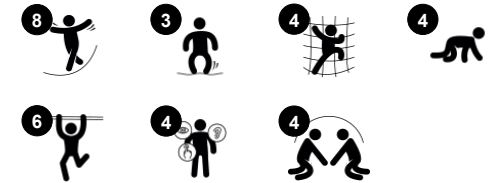

Children respond with curiosity and engagement to the Howler Trail, which offers climbing opportunities that test and strengthen agility, balance and coordination. These skills are necessary for overall physical fitness, and they inspire the good feelings related to being physically active and setting goals to meet and accomplish. The trail offers both high speed

loop of play as well as socialization and friendship-building activities. The carefully designed structure permits many children to play at once, encouraging them to navigate through the trail as they make space for each other to reach the top or navigate around. All in all, the Howler Trail inspires children to delight in the playground activities.



Data is subject to change without prior notice.

Howler Trail

CRP251101

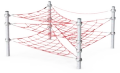

Spix's Trail

Physical: children develop cross-body coordination and sense of balance when balancing on and climbing the nets. **Social-Emotional:** the big meshes allow for more children being seated or lying together.

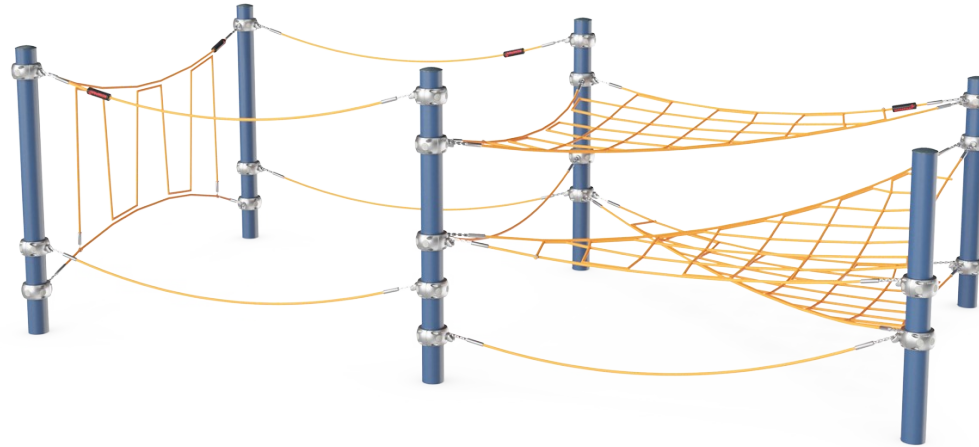

Tightrope

Physical: children train cross-body coordination and muscle strength. The big meshes allow for climbing and crawling through, training proprioception and spatial awareness. **Social-Emotional:** the big meshes allow for more children being seated together, sharing.



Balancing ropes

Physical: holding onto the swaying upper rope when balancing on the swaying lower rope makes excellent training of the sense of balance and trunk muscles. These abilities are fundamental for being able to sit still. **Social-Emotional:** there is room for more than one and cooperating with friends on walking over the swaying ropes is a true cooperation task that requires teamwork and tolerance.

Howler Trail

CRP251101



Ropes of UV-stabilized PES rope strands with inner steel cable reinforcement. The polyester yarn is made from +95% post-consumer materials and is inductively melted onto each strand.



Corocord 'S' clamps are used as universal connections in Corocord products. 8mm stainless steel rods with rounded edges are pressed around the ropes with a special hydraulic press, making them the ideal connector: safe, durable and vandalism-proof, all while allowing the typical movement of rope play structures.



Corocord smart clamps are carefully designed in every detail to ensure superior flexibility in high quality aluminum material. The smart clamps are attached around the posts with four steel bolts. Not used attachment points are closed with PA caps.



Colored steel components have a base of hot dip galvanization and a powder coated top finish. This provides an ultimate corrosion resistance in all climates around the world. Other steel surfaces are hot dip galvanized inside and outside with lead free zinc.

Item no. CRP251101-0903

Installation Information

Max. fall height	150 cm
Safety surfacing area	52.8 m ²
Total installation time	14.7
Excavation volume	10.58 m ³
Concrete volume	5.88 m ³
Footing depth (standard)	90 cm
Shipment weight	660 kg
Anchoring options	Surface ✓ In-ground ✓

Warranty Information

Aluminium clamps	10 years
Hot dip galvanised steel	Lifetime
Painted toplayer	10 years
Ropes & nets	10 years
Spare parts guaranteed	10 years



Sustainability Data

CRP251101

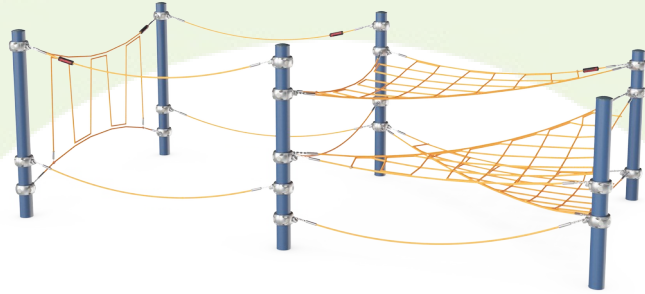

Cradle to Gate A1-A3	Total CO ₂ emission	CO ₂ e/kg	Recycled materials
	kg CO ₂ e	kg CO ₂ e/kg	%
CRP251101-0903	1,494.53	3.53	45.93

The overall framework applied for these factors is the Environmental Product Declaration (EPD), which quantifies "environmental information on the life cycle of a product and enable comparisons between products fulfilling the same function" (ISO, 2006). This follows the structure and applies a Life-Cycle Assessment approach to the entire Product stage from raw material through manufacturing (A1-A3))

Kompan A/S
 C.F. Tietgens Boulevard 32C
 DK-5220 Odense SØ
 Denmark



Verification of CO₂ calculation of: Corocord



Data version no. 2023-10-05

The CO₂ calculation and data are in compliance with the principles of a carbon footprint impact according to the GHG protocol (Greenhouse Gas Protocol), Scope 3, cradle to gate related to all individual components in the product category: "Corocord" represented by item no.: COR314011-1101.

(Scope 3 emissions include emission sources in the upstream and downstream value chain).

Date: 30. October 2023 | Valid until: 30. October 2025

Verified by:

Julie Marie Vejsgaard Larsen, LCA & EPD Consultant

Verification based on report: Validation of CO₂ calculation of 9 categories of Kompan product line, version 1.0, prepared by: Bureau Veritas HSE, Denmark: Julie M. V. Larsen.

Publication date: 30. October 2023

By Bureau Veritas HSE
 www.bureauveritas.dk
 +45 7731 1000



Howler Trail

CRP251101

* Max fall height | ** Total height | *** Safety surfacing area

* Max fall height | ** Total height

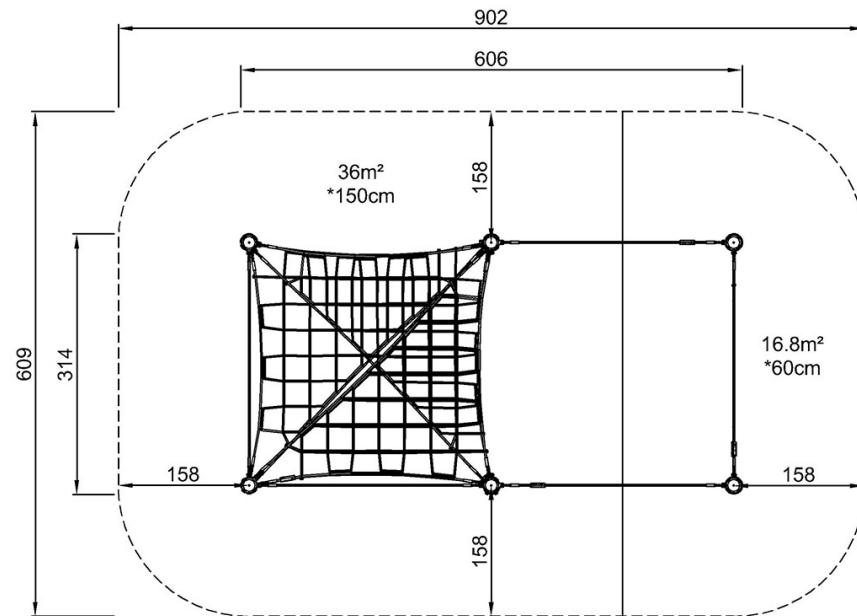

CRP251101
*150cm
**197cm
***52.8m²

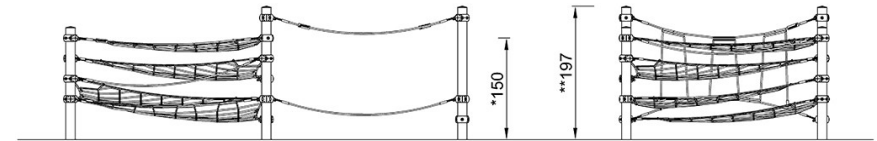

CRP251101

[Click to see TOP VIEW](#)

[Click to see SIDE VIEW](#)