

Cloud Climber

MSC5401



Item no. MSC540100-3417P

General Product Information

Dimensions LxWxH	165x76x125 cm
Age group	1+
Play capacity (users)	2
Color options	

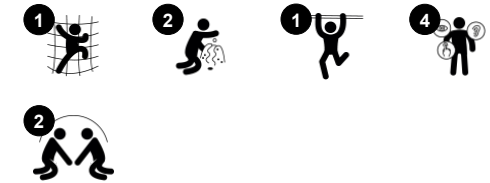

Wow! The cloud climber is hugely attractive to the active toddler. The cute design encourages toddlers to reach for the clouds, and develop their emerging physical skills. Graduated challenge in toddler play is built in. The youngest children enjoy pulling themselves up and cruising around the structure to play with their parents and friends, having a short rest at

the yellow seat in between. Older toddlers will have a go at climbing. These activities support gross motor development and cross-coordination. This is important in the development of reading skills, as these depend on cross-modal perception, developed in for instance climbing movement. The structure is loaded with the kind of play that keeps toddlers

occupied – lots of things to touch and move, and a transparent design that supports social play.



Cloud Climber

MSC5401

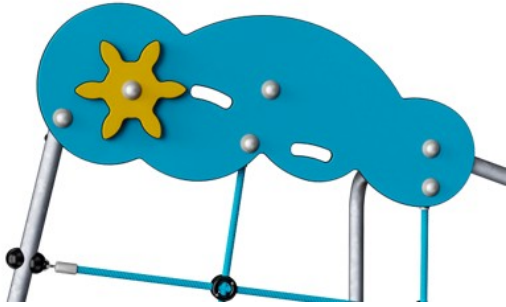

Panels of 19mm EcoCore™. EcoCore™ is a highly durable, eco friendly material, which is not only recyclable after use, but also consists of material produced from +95% recycled post consumer material from food packing waste.

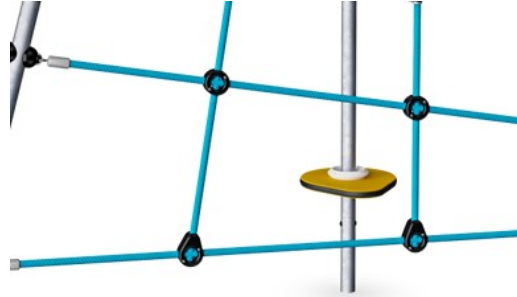

Nets and ropes are made of UV-stabilised PA with inner steel cable reinforcement. The rope is induction treated in order to create a strong connection between steel and rope which leads to good wear resistance.



The steel support posts are hot dip galvanised inside and outside with lead free zinc. The galvanisation has excellent corrosion resistance in outside environments and requires low maintenance.

Item no. MSC540100-3417P

Installation Information

Max. fall height	72 cm
Safety surfacing area	13.5 m ²
Total installation time	3.2
Excavation volume	0.13 m ³
Concrete volume	0.00 m ³
Footing depth (standard)	60 cm
Shipment weight	28 kg
Anchoring options	In-ground ✓ Surface ✓



Sustainability Data

MSC5401

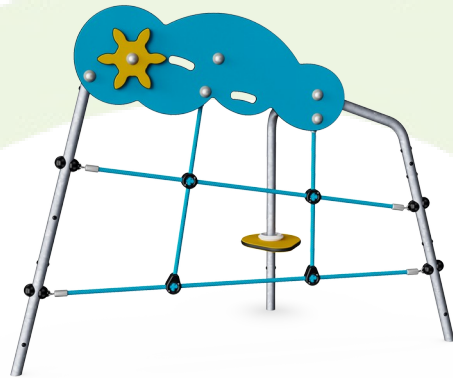

Cradle to Gate A1-A3	Total CO ₂ emission	CO ₂ e/kg	Recycled materials
	kg CO ₂ e	kg CO ₂ e/kg	%
MSC540100-3417P	74.20	2.97	52.50

The overall framework applied for these factors is the Environmental Product Declaration (EPD), which quantifies "environmental information on the life cycle of a product and enable comparisons between products fulfilling the same function" (ISO, 2006). This follows the structure and applies a Life-Cycle Assessment approach to the entire Product stage from raw material through manufacturing (A1-A3))

Kompan A/S
 C.F. Tietgens Boulevard 32C
 DK-5220 Odense SØ
 Denmark



Verification of CO₂ calculation of: Themed play systems

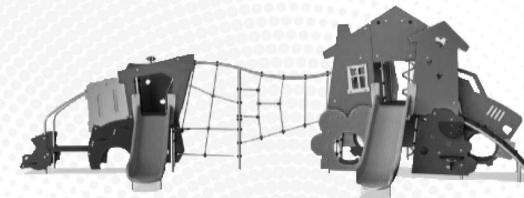

Data version no. 2023-10-05

The CO₂ calculation and data are in compliance with the principles of a carbon footprint impact according to the GHG protocol (Greenhouse Gas Protocol), Scope 3, cradle to gate related to all individual components in the product category: "Themed play systems" represented by item no.: MSC641100-3717P.

(Scope 3 emissions include emission sources in the upstream and downstream value chain).

Date: 30. October 2023 | Valid until: 30. October 2025

Verified by:

Julie Marie Vejsgaard Larsen, LCA & EPD Consultant

Verification based on report: Validation of CO₂ calculation of 9 categories of Kompan product line, version 1.0, prepared by: Bureau Veritas HSE, Denmark: Julie M. V. Larsen.

Publication date: 30. October 2023

By Bureau Veritas HSE
 www.bureauveritas.dk
 +45 7731 1000



Cloud Climber

MSC5401

* Max fall height | ** Total height | *** Safety surfacing area

* Max fall height | ** Total height

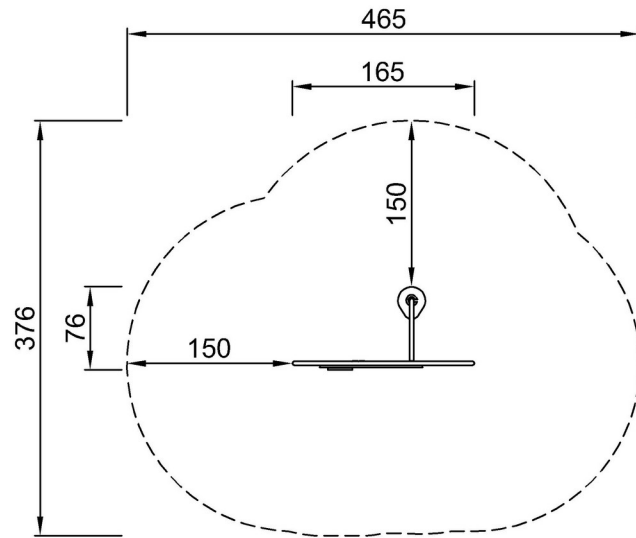

MSC540100P
*72cm
**125cm
***13.5m²

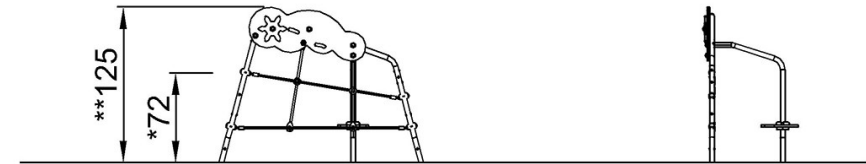

MSC540100P

[Click to see TOP VIEW](#)

[Click to see SIDE VIEW](#)