

Small Rope Play Tower

COR29500

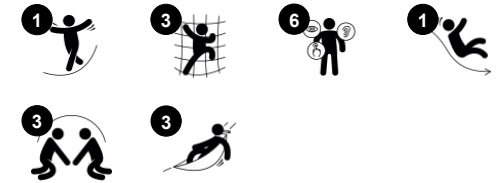

Item no. COR295001-1103	
General Product Information	
Dimensions LxWxH	784x243x650 cm
Age group	5+
Play capacity (users)	13
Colour options	



The Rope Play Tower has the WOW factor. This inspiring play structure will encourage hours of challenge and thrilling reward from active play. The challenging climb up to the platform of the play tower is rewarded by a view of the environment and a thrilling slide down to start the climb again. Climbing on the Rope Play Tower is challenging, it trains the

motor skills' ABCs: Agility, Balance and Coordination. Its impressive presence on the playground will also attract children to stay and play, which will support their physical skills and encourage a positive attitude toward a healthy lifestyle. The structure will allow many children to play, which encourages socialization and turn-taking skills, that support healthy

emotional development and a sense of community.



Small Rope Play Tower

COR29500



Height

Social-Emotional: children develop courage and self-regulation when being up high. This positively affects self-confidence.



Climbing net

Physical: the inclined net supports the upward climbing movement of the body. Cross-coordination, spatial awareness and physical strength are trained, due to big steps when wanting to climb up fast. **Social-Emotional:** the big meshes allow for more children being seated together, sharing.



Slide

Physical: sliding develops spatial awareness and a sense of balance. Furthermore, the core muscles are trained when sitting upright going down. **Social-Emotional:** empathy stimulated by turn-taking.



Platform

Social-Emotional: Important life skills like courage, self-confidence, consideration and turn-taking are built.

Small Rope Play Tower

COR29500



Ropes of UV-stabilized PES rope strands with inner steel cable reinforcement. The polyester yarn is made from +95% post-consumer materials and is inductively melted onto each strand. The ropes are highly wear-and vandalism-resistant and can be replaced at site if needed.



Corocord 'S' clamps are used as universal connections in Corocord products. 8mm stainless steel rods with rounded edges are pressed around the ropes with a special hydraulic press, making them the ideal connector: safe, durable and vandalism-proof, all while allowing the typical movement of rope play structures.



Corocord aluminium clamps are used as connectors between steel posts and rope. Two aluminium castings are bolted together. The height of the clamps is thus variable.



Corocord membranes consist of friction-proof rubberized material of conveyor belt quality with excellent UV resistance. Tested and compliant with REACH requirements for PAH. Embedded is a four-layered armoring made of woven polyester. The armoring and the two surface layers result in a total thickness of 7.5 mm.



The metal parts are made of high quality steel, hot dip galvanised inside and outside with leadfree zinc. On the outside, there is an additional layer of powder coating. This ensures both excellent corrosion resistance and colourful design expression.

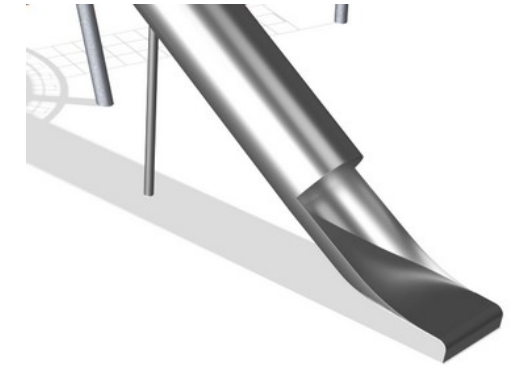

The stainless steel components are made of high quality stainless steel in compliance with global playground standards. The steel is glass blasted after manufacturing to ensure a smooth gliding surface.

Item no. COR295001-1103	
Installation Information	
Max. fall height	270 cm
Safety surfacing area	45.3 m ²
Total installation time	42.9
Excavation volume	8.08 m ³
Concrete volume	5.10 m ³
Footing depth (standard)	110 cm
Shipment weight	1,734 kg
Anchoring options	In-ground ✓
Warranty Information	
Corocord rope	10 years
Hot dip galvanised steel	Lifetime
Membrane	2 years
S-Clamps	10 years
Spare parts guaranteed	10 years



Sustainability Data

COR29500



Cradle to Gate A1-A3	Total CO ₂ emission	CO ₂ e/kg	Recycled materials
	kg CO ₂ e	kg CO ₂ e/kg	%
COR295001-1103	4,423.44	2.93	52.52

The overall framework applied for these factors is the Environmental Product Declaration (EPD), which quantifies "environmental information on the life cycle of a product and enable comparisons between products fulfilling the same function" (ISO, 2006). This follows the structure and applies a Life-Cycle Assessment approach to the entire Product stage from raw material through manufacturing (A1-A3))

Kompan A/S
 C.F. Tietgens Boulevard 32C
 DK-5220 Odense SØ
 Denmark



Verification of CO₂ calculation of: Corocord



Data version no. 2023-10-05

The CO₂ calculation and data are in compliance with the principles of a carbon footprint impact according to the GHG protocol (Greenhouse Gas Protocol), Scope 3, cradle to gate related to all individual components in the product category: "Corocord" represented by item no.: COR314011-1101.

(Scope 3 emissions include emission sources in the upstream and downstream value chain).

Date: 30. October 2023 | Valid until: 30. October 2025

Verified by:

Julie Marie Vejsgaard Larsen, LCA & EPD Consultant

Verification based on report: Validation of CO₂ calculation of 9 categories of Kompan product line, version 1.0, prepared by: Bureau Veritas HSE, Denmark: Julie M. V. Larsen.

Publication date: 30. October 2023

By Bureau Veritas HSE
 www.bureauveritas.dk
 +45 7731 1000



Small Rope Play Tower

COR29500

* Max fall height | ** Total height | *** Safety surfacing area

* Max fall height | ** Total height

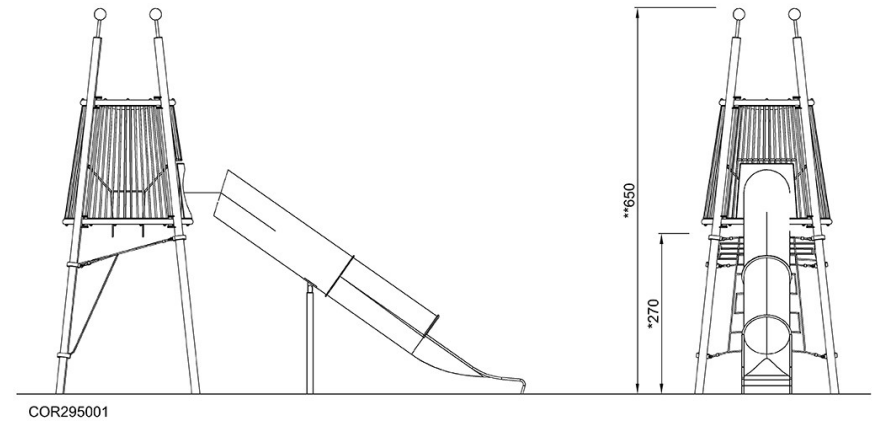
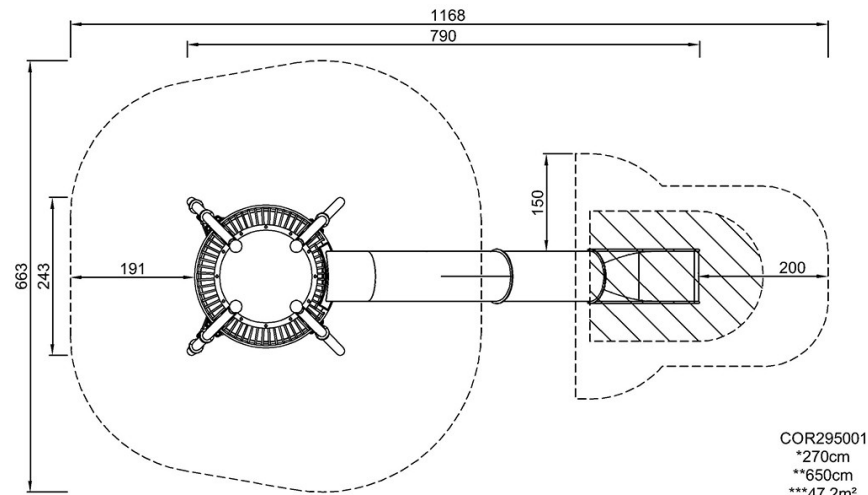

[Click to see TOP VIEW](#)

[Click to see SIDE VIEW](#)