

Three Towers with Net & Bridge

PCM300821

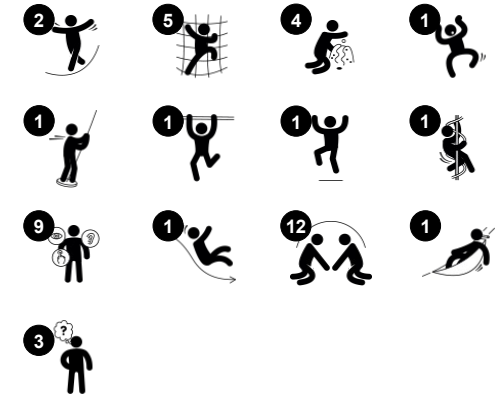

Item no. PCM300821-0602	
General Product Information	
Dimensions LxWxH	363x567x306 cm
Age group	2+
Play capacity (users)	28
Colour options	



This fantastic play tower has three towers and multiple ways to enter that will encourage children to be active, supporting the development of their muscles as well as social skills. The play panels are designed to support cognitive skills as well as emotional awareness in play, essential for early development. The net bridge provides a connection between play

activities and encourages movement. It also provides a challenge along with the opportunity for children to assess risk and feel the sense of accomplishment when they work toward mastering the physical activities. Navigating the nets also supports the development of cross-coordination, a skill that enhances physical as well as cognitive development. Sliding down

the slide or gliding down the Fireman's Pole to the ground supports posture and balance, all important skills for young children, and great fun!

Three Towers with Net & Bridge

PCM300821



Talk tube
Social-Emotional: encourages communication and social interaction.
Cognitive: evokes curiosity and stimulates an understanding of cause and effect and object permanence: objects and persons exist also when out of sight.



Faces panel
Social-Emotional: spurs group play and conversations with its two-sidedness.
Cognitive: stimulates theory of mind: that others may have different feelings. Stimulates the understanding of symbols and facial expressions as symbols for emotions.



Climbing net
Physical: children develop cross-body coordination and muscle strength when climbing. The big meshes allow for climbing and crawling through, supporting proprioception and spatial awareness. **Social-Emotional:** the big meshes allow for more children to sit together and talk.



Fireman's pole
Physical: coordination is supported when going down, as well as arm and core muscles. Landing strengthens bone density, which is built for life in early childhood. **Social-Emotional:** turn-taking and risk-taking. **Cognitive:** young children develop their understanding of space, speed and distances when gliding down fast.



Net bridge, inclined
Physical: walking the open net up or downwards develops balance, spatial awareness and cross coordination. **Social-Emotional:** interaction with children outside, socializing. Cooperation and consideration, e.g. when passing others.



Balcony
Social-Emotional: the balcony invites meetings and interaction with people on ground level. **Cognitive:** invites dramatic play and performance, which stimulates language development.



Slide
Physical: sliding develops spatial awareness and a sense of balance. Furthermore, the core muscles are trained when sitting upright going down. **Social-Emotional:** empathy stimulated by turn-taking. **Cognitive:** young children develop their understanding of space, speed and distances when sliding down quickly.

Three Towers with Net & Bridge

PCM300821



Panels of 19mm EcoCore™. EcoCore™ is a highly durable, eco friendly material, which is not only recyclable after use, but is also produced from +95% recycled post consumer material from food packing waste. Wooden panels of impregnated and brown painted pine wood with vertical steel profiles.



Main posts with hot dip galvanized steel footing are available in different materials: Pressure impregnated pine wood posts. Pre-galvanized inside and outside with powder coated top finish steel posts. Lead free aluminum with color anodized top finish. Greenline TexMade posts of 95% post-consumer recycled PE and textile waste.



All decks are supported by unique designed low-carbon aluminum profiles with multiple attachment options. The grey colored molded decks are made of 75% post-consumer waste PP material with a non-skid pattern and texture surface.

Item no. PCM300821-0602

Installation Information

Max. fall height	118 cm
Safety surfacing area	41.9 m ²
Total installation time	26.2
Excavation volume	0.67 m ³
Concrete volume	0.00 m ³
Footing depth (standard)	60 cm
Shipment weight	756 kg
Anchoring options	In-ground ✓ Surface ✓

Warranty Information

EcoCore HDPE	Lifetime
Post	10 years
PP Decks	10 years
Ropes & nets	10 years
Spare parts guaranteed	10 years

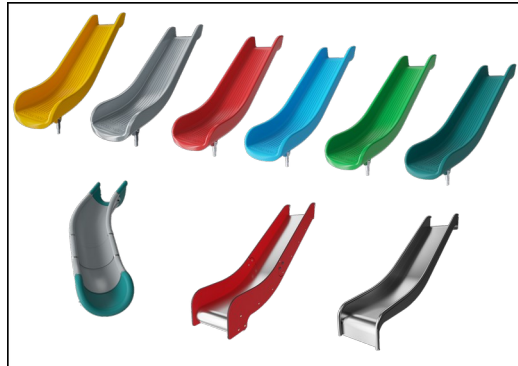

The slides can be chosen in six different colors and three materials: Straight or curved one-piece molded PE slides, made from 33% recycled post-consumer materials in different colours. Combined EcoCore™ sides and stainless-steel. Full stainless steel in one piece design for more vandalism proof solutions.

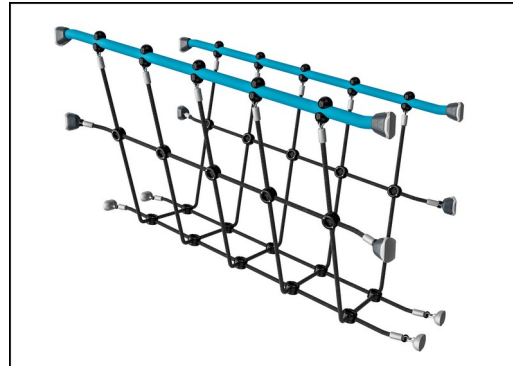

Nets and ropes are made of UV-stabilised PA with inner steel cable reinforcement. The rope is induction treated in order to create a strong connection between steel and rope which leads to good wear resistance.



KOMPAN GreenLine versions are designed with ultimate environmentally friendly materials with lowest possible CO2e emission factor. TexMade post, EcoCore™ panels of 95% post-consumer recycled waste and molded PP decks.



Sustainability Data

PCM300821



Cradle to Gate A1-A3	Total CO ₂ emission	CO ₂ e/kg	Recycled materials
	kg CO ₂ e	kg CO ₂ e/kg	%
PCM300821-0651	1,096.00	1.75	70.18
PCM300821-0602	1,510.77	2.83	51.98

The overall framework applied for these factors is the Environmental Product Declaration (EPD), which quantifies "environmental information on the life cycle of a product and enable comparisons between products fulfilling the same function" (ISO, 2006). This follows the structure and applies a Life-Cycle Assessment approach to the entire Product stage from raw material through manufacturing (A1-A3))

Kompan A/S
C.F. Tietgens Boulevard 32C
DK-5220 Odense SØ
Denmark



Verification of CO₂ calculation of: Play systems



Data version no. 2023-10-05

The CO₂ calculation and data are in compliance with the principles of a carbon footprint impact according to the GHG protocol (Greenhouse Gas Protocol), Scope 3, cradle to gate related to all individual components in the product category: "Play systems" represented by item no.: PCM200321-0950.

(Scope 3 emissions include emission sources in the upstream and downstream value chain).

Date: 30. October 2023 | Valid until: 30. October 2025

Verified by:

Julie Marie Vejsgaard Larsen, LCA & EPD Consultant

Verification based on report: Validation of CO₂ calculation of 9 categories of Kompan product line, version 1.0, prepared by: Bureau Veritas HSE, Denmark: Julie M. V. Larsen.

Publication date: 30. October 2023

By Bureau Veritas HSE
www.bureauveritas.dk
+45 7731 1000



Three Towers with Net & Bridge

PCM300821

* Max fall height | ** Total height | *** Safety surfacing area

* Max fall height | ** Total height

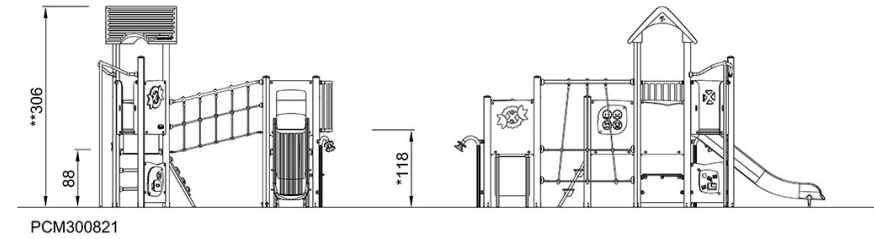
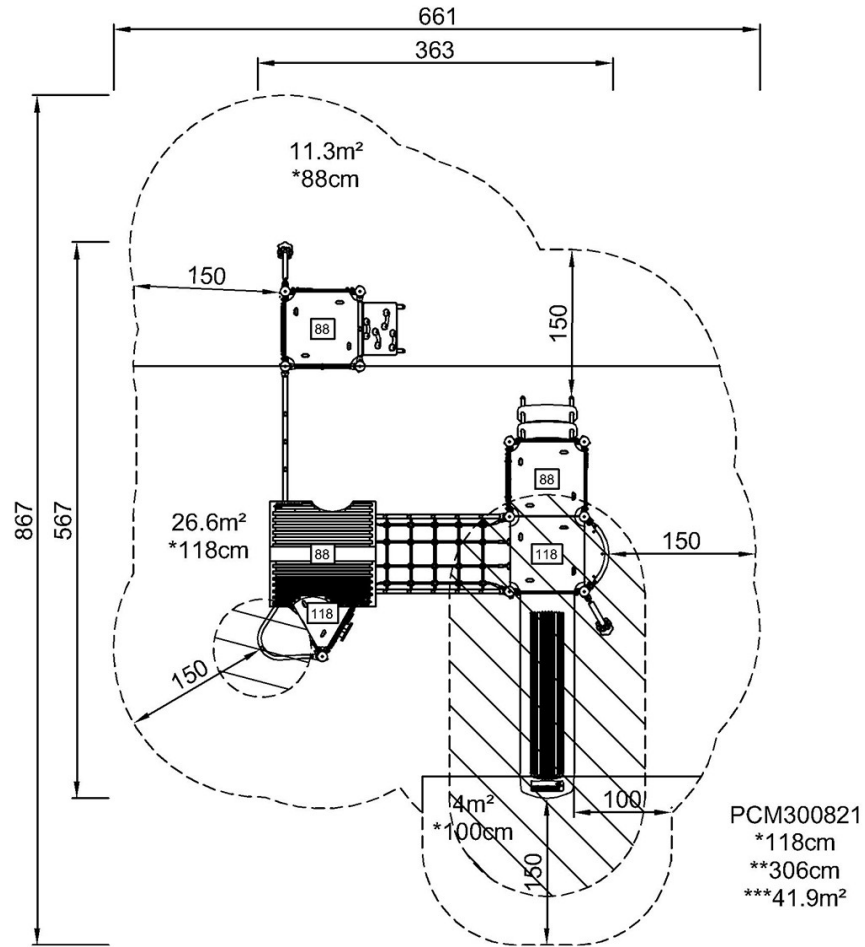

[Click to see TOP VIEW](#)

[Click to see SIDE VIEW](#)