

# Mini Car

M531

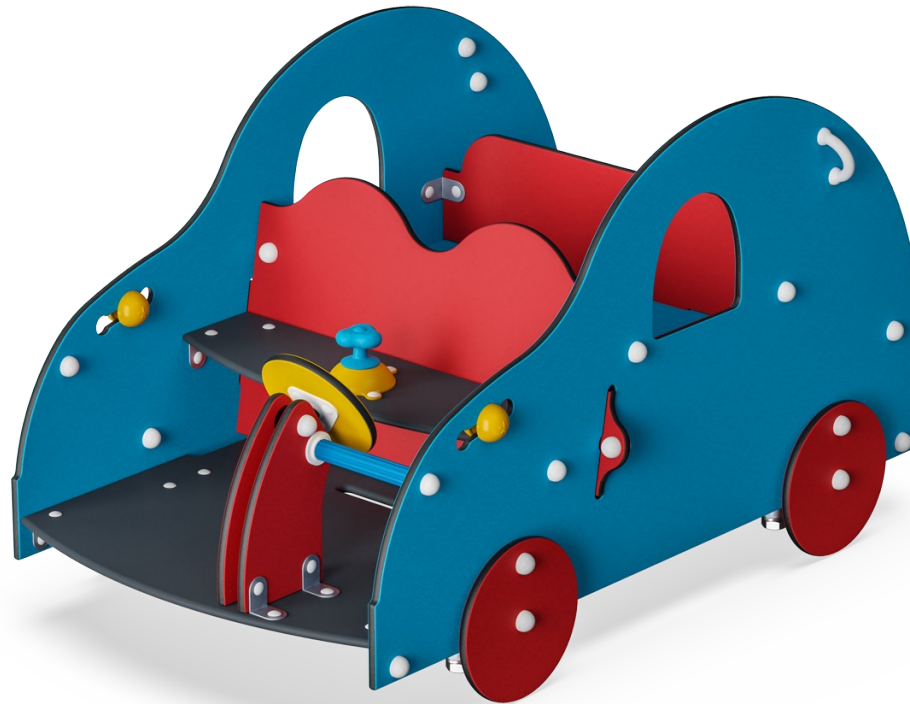

Item no. M53170-3313P	
<b>General Product Information</b>	
Dimensions LxWxH	103x176x98 cm
Age group	1+
Play capacity (users)	6
Colour options	

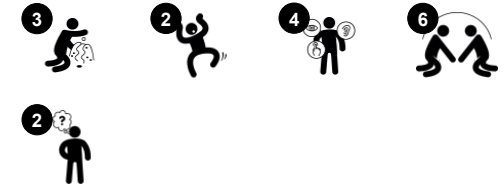

The Mini Car signals play loud and clear and attracts infants and toddlers again and again. The cute rounded shapes and the vibrant colours attract. And the manipulative steering wheel, gear and yellow headlight spheres can be handled and turned again and again. The car has three compartments, two of which are relatively open to the front and rear directions.

They both offer ample seating, and the rear also features two tinkering tables. The themes of traffic and cars are well-known to toddlers. They take a starting point in the toddlers' near world and open the scope of going into the wider world. Dramatic play scenarios such as visiting family are played out repeatedly in the Mini Car. This is an important contribution to

the development of language skills and literacy.

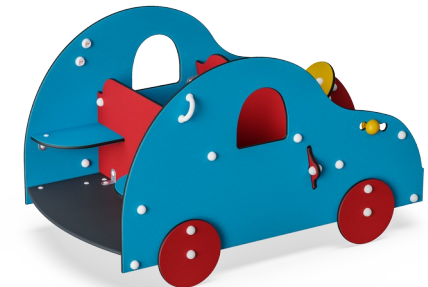

# Mini Car

M531



## Bench

**Social-Emotional:** gathering, cooperating or taking a break from play - all train social skills.



## Window

**Social-Emotional:** invites interaction between sides and cooperative play.



## Theme

**Cognitive:** suggests a theme and supports dramatic play, which stimulates language and communication skills.

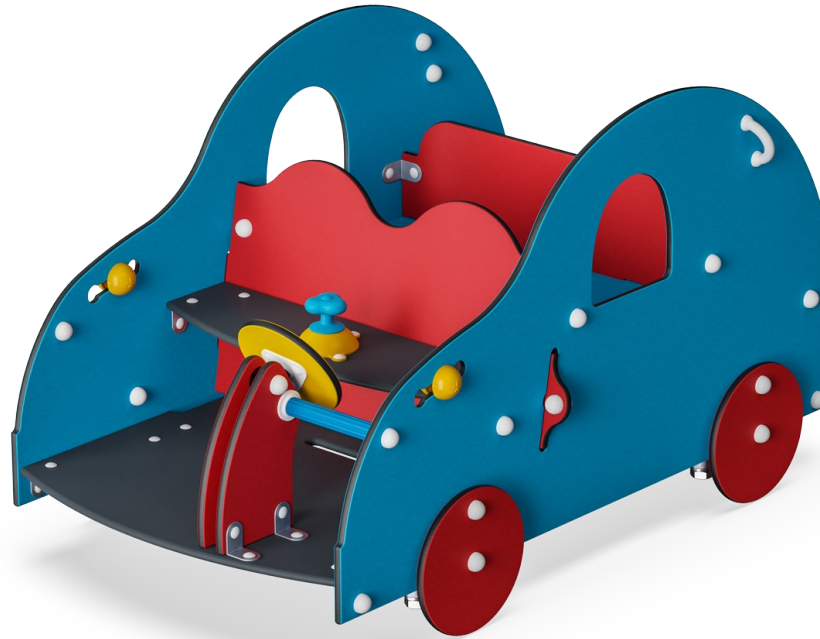

## Gear shift

**Social-Emotional:** cooperation, turn-taking, sharing. **Cognitive:** suggests a theme and supports dramatic play, which stimulates languages skills.



## Turning wheel

**Cognitive:** the manipulative item stimulates cause and effect understanding.



## Play sphere

**Social-Emotional:** can be played from both sides, encouraging cooperation. **Cognitive:** cause and effect understanding. **Creative:** leave a mark and place the spheres at different positions.

# Mini Car

M531



Panels of 19mm EcoCore™. EcoCore™ is a highly durable, eco friendly material, which is not only recyclable after use, but also consists of material produced from +95% recycled post consumer material from food packing waste.

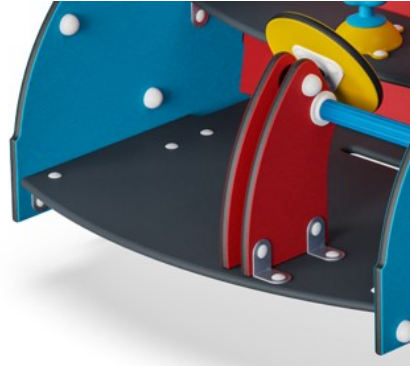

Foot support is made of HPL with a thickness of 17,8mm with a very high wearing strength and a unique KOMPAN nonskid surface texture.



Handle is made of polypropylene PP with excellent impact strength and usable within a large temperature span.

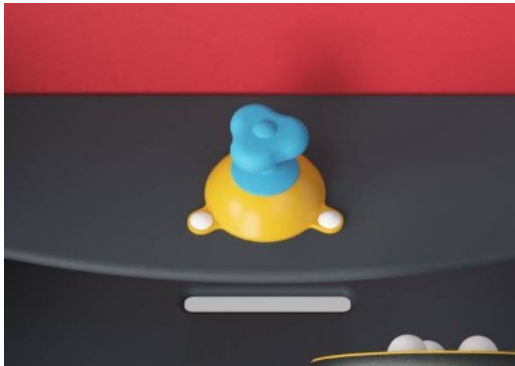

Gear shift is made of PP. PP has good wearing and impact resistance.

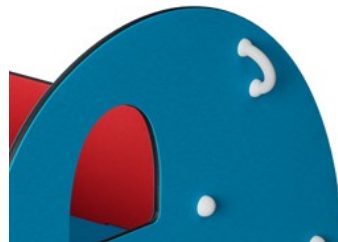

Handholds are made of injection moulded high quality nylon (PA6). PA6 has good wearing and impact strength.

Item no. M53170-3313P

### Installation Information

Max. fall height	45 cm
Safety surfacing area	17.3 m <sup>2</sup>
Total installation time	5.6
Excavation volume	0.15 m <sup>3</sup>
Concrete volume	0.00 m <sup>3</sup>
Footing depth (standard)	42 cm
Shipment weight	215 kg
Anchoring options	In-ground ✓ Surface ✓

### Warranty Information

EcoCore HDPE	Lifetime
Hot dip galvanised steel	Lifetime
HPL decks	15 years
PE/PP components	5 years
Spare parts guaranteed	10 years



# Sustainability Data

M531

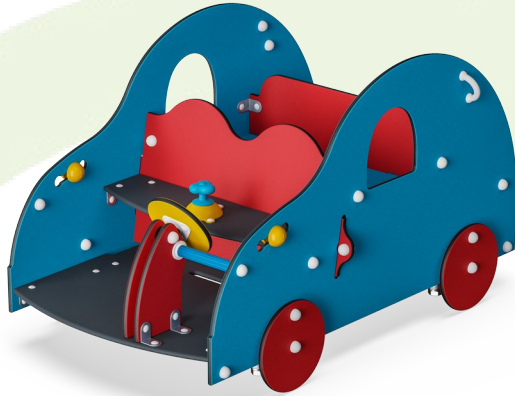

<b>Cradle to Gate A1-A3</b>	<b>Total CO<sub>2</sub> emission</b>	<b>CO<sub>2</sub>e/kg</b>	<b>Recycled materials</b>
	kg CO <sub>2</sub> e	kg CO <sub>2</sub> e/kg	%
<b>M53170-3313P</b>	223.84	1.60	55.59

The overall framework applied for these factors is the Environmental Product Declaration (EPD), which quantifies "environmental information on the life cycle of a product and enable comparisons between products fulfilling the same function" (ISO, 2006). This follows the structure and applies a Life-Cycle Assessment approach to the entire Product stage from raw material through manufacturing (A1-A3))

# Mini Car

M531

\* Max fall height | \*\* Total height | \*\*\* Safety surfacing area

\* Max fall height | \*\* Total height

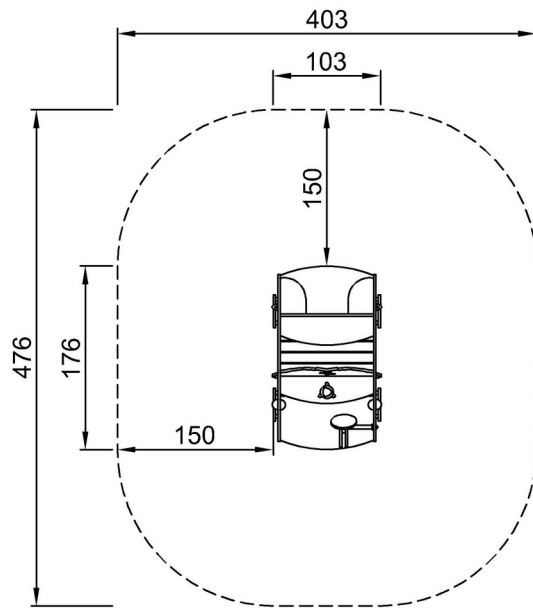

M53170P  
\*45cm  
\*\*98cm  
\*\*\*17.3m<sup>2</sup>



M53170P

[Click to see TOP VIEW](#)

[Click to see SIDE VIEW](#)