

Double Tower with Banister Bars

KPL2015

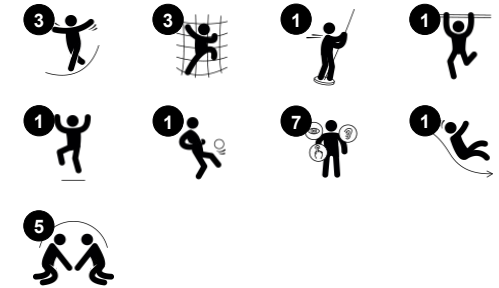

Item no. KPL201511-0902	
General Product Information	
Dimensions LxWxH	408x438x346 cm
Age group	6+
Play capacity (users)	14
Colour options	● ●



The Double Tower With Banister Bars offers highly attractive play variation to make children play for a long time. The access points have varied difficulty and thrill levels, as well as the egresses: The fireman's pole is for more seasoned players, training risk-taking and proprioception. For children who want to play it safer, the slide section allows for high-paced,

cardio and balance packed looping. The bridge invites thrilling balance training with friends, encouraging cooperation and consideration of others. It also trains the senses of balance and space, important for managing the world securely. On ground level a play panel creates a gathering corner to meet with friends. The balance of more thrilling and more well-known

play activities makes this a versatile challenge for most children. They will meet, turn-take and cooperate in play, building up important socio-emotional skills and friendships.

Double Tower with Banister Bars

KPL2015



Net bridge, inclined

Physical: walking the open net up or downwards develops balance, spatial awareness and cross coordination. **Social-Emotional:** interaction with children outside, socializing. Cooperation and consideration, e.g. when passing others.



Climbing pole

Physical: cross coordination and muscle strength are trained. **Social-Emotional:** turn-taking and cooperation.

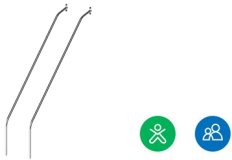

Banister bars

Physical: coordination is supported when going down, as well as arm and core muscles. Landing strengthens bone density, which is built for life in childhood. **Social-Emotional:** turn-taking and risk-taking.

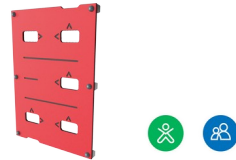

Climbing wall

Physical: develops children's cross coordination, eye-hand coordination, and muscle strength when climbing. **Social-Emotional:** two-sided climb invites cooperation.



Slide

Physical: sliding develops spatial awareness and a sense of balance. Furthermore, the core muscles are trained when sitting upright going down. **Social-Emotional:** empathy stimulated by turn-taking.



Maze panel

Social-Emotional: communication and cooperation exploring the maze with friends. **Cognitive:** stimulates memory when memorizing maze routes.

Double Tower with Banister Bars

KPL2015



Panels of 19mm EcoCore™. EcoCore™ is a highly durable, eco friendly material, which is not only recyclable after use, but also consists of material produced from +95% recycled post consumer material from food packing waste.

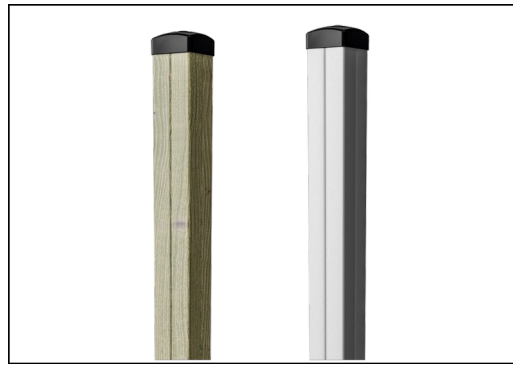

The main tower posts of either pine wood or aluminium are all equipped with hot dip galvanised steel footings. The steel footings elevates the posts 20mm from ground level to avoid contact with surfacing material.

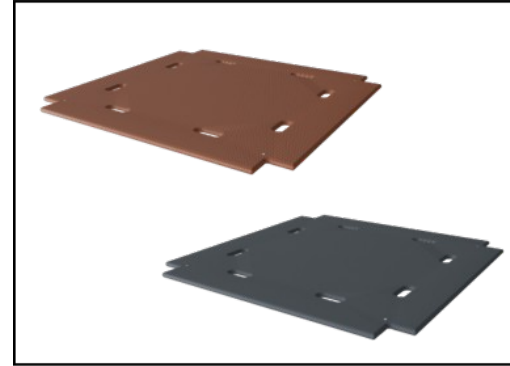

Floors and panel activities are available in two types of material: Waterproof plywood decks thickness 21.5mm from pine and alder wood with anti-slip film on both sides. High Pressure Laminate HPL thickness 17.8mm with slip resistant surface texture according to EN 438-6.

Item no. KPL201511-0902

Installation Information

Max. fall height	209 cm
Safety surfacing area	42.5 m ²
Total installation time	12.5
Excavation volume	1.43 m ³
Concrete volume	0.50 m ³
Footing depth (standard)	90 cm
Shipment weight	414 kg
Anchoring options	In-ground ✓ Surface ✓

Warranty Information

Aluminum	15 years
EcoCore HDPE	Lifetime
Pinewood	10 years
Ropes & nets	10 years
Spare parts guaranteed	10 years

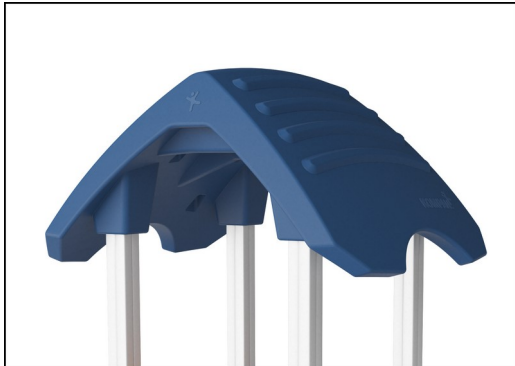

The large hollow components are made of 100% recyclable PE. The roof displayed is moulded in one piece with minimum 5,5mm wall thickness to ensure high durability in all climates around the world.

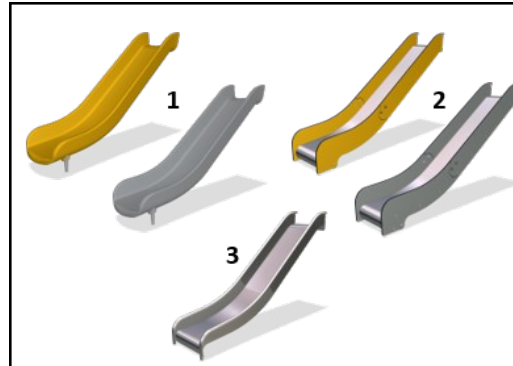

Slides are available in three different materials: moulded on piece PE slides made from 33% post-consumer materials, Combined EcoCore™ sides and stainless steel slide bed t=2mm. Full stainless steel AISI304 t=2mm.



Climbing nets are made of UV-stabilised PP rope with inner steel cable reinforcement. The rope is induction treated to obtain maximum fixation between steel and rope which provides excellent wear and tear resistance. All rope connectors are made of 100% recyclable PA material.



Sustainability Data

KPL2015



Cradle to Gate A1-A3	Total CO ₂ emission	CO ₂ e/kg	Recycled materials
	kg CO ₂ e	kg CO ₂ e/kg	%
KPL201511-0902	538.55	1.65	33.34

The overall framework applied for these factors is the Environmental Product Declaration (EPD), which quantifies "environmental information on the life cycle of a product and enable comparisons between products fulfilling the same function" (ISO, 2006). This follows the structure and applies a Life-Cycle Assessment approach to the entire Product stage from raw material through manufacturing (A1-A3))

Kompan A/S
 C.F. Tietgens Boulevard 32C
 DK-5220 Odense SØ
 Denmark



Verification of CO₂ calculation of: Play systems



Data version no. 2023-10-05

The CO₂ calculation and data are in compliance with the principles of a carbon footprint impact according to the GHG protocol (Greenhouse Gas Protocol), Scope 3, cradle to gate related to all individual components in the product category: "Play systems" represented by item no.: PCM200321-0950.

(Scope 3 emissions include emission sources in the upstream and downstream value chain).

Date: 30. October 2023 | Valid until: 30. October 2025

Verified by:

Julie Marie Vejsgaard Larsen, LCA & EPD Consultant

Verification based on report: Validation of CO₂ calculation of 9 categories of Kompan product line, version 1.0, prepared by: Bureau Veritas HSE, Denmark: Julie M. V. Larsen.

Publication date: 30. October 2023

By Bureau Veritas HSE
 www.bureauveritas.dk
 +45 7731 1000



Double Tower with Banister Bars

KPL2015

* Max fall height | ** Total height | *** Safety surfacing area

* Max fall height | ** Total height

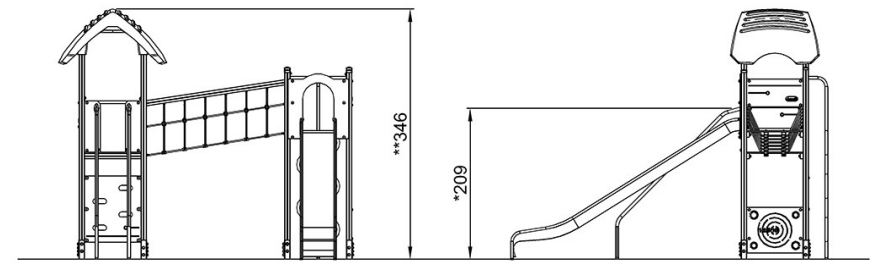
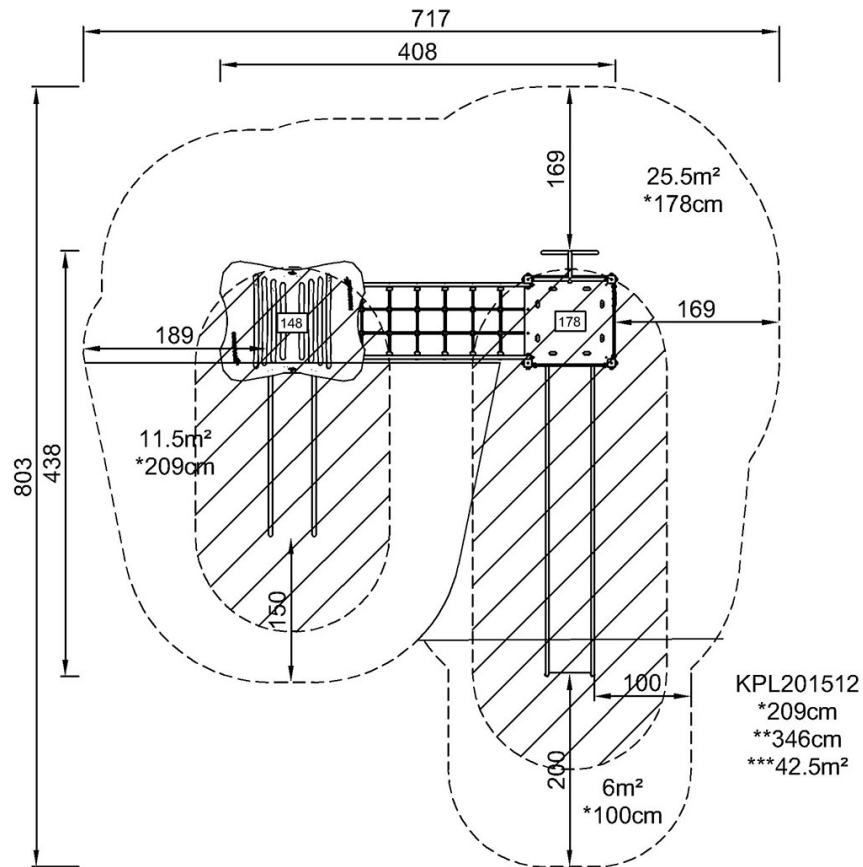

KPL201512

[Click to see TOP VIEW](#)

[Click to see SIDE VIEW](#)