

Net Tower with ADA Stairs

MSC6419

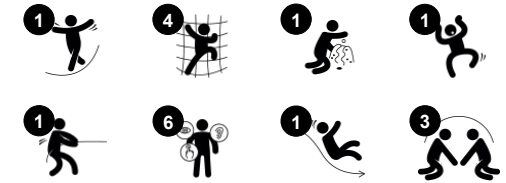

Item no. MSC641900-3717P	
General Product Information	
Dimensions LxWxH	611x260x234 cm
Age group	2+
Play capacity (users)	12
Colour options	



This incredible net tower with ADA stairs attracts children with its red flag and multiple play options. The transparent net alone invites for intense, varied climbing and crawling through. Or, just for being seated on a rung, enjoying the bounce created by climbing friends. Climbing and crawling the Net Tower, as well as being fun, trains children's cross-

coordination and spatial awareness, which are both fundamental motor skills. They help children manage their bodies and the world confidently. The tower adds to play with is great climbing wall and outlook post. The slide adds a thrilling ride back to the ground and it additionally trains the sense of balance. The ADA stairway makes the Net Tower accessible

for all and also adds a meeting and rest point for all. Here all children can meet and make friends during play.



Net Tower with ADA Stairs

MSC6419

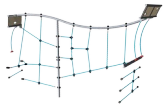

Climbing net

Physical: children develop cross-body coordination and muscle strength. The asymmetry of the net challenges the children's climbing.



Slide

Physical: sliding develops spatial awareness and a sense of balance. Furthermore, the core muscles are trained when sitting upright going down. **Social-Emotional:** empathy stimulated by turn-taking. **Cognitive:** young children develop their understanding of space, speed and distances when sliding down quickly.



Binoculars

Cognitive: the binoculars set a tangible theme and thus spur dramatic play. Dramatic play is a great trainer of language and communication skills. **Creative:** the binoculars can be turned in all directions. Looking through them gives a new perspective on the world.



Accessible stairway

Physical: climbing the accessible stairway is for all and supports cross coordination as well as arm and leg muscles. For young children, walking stairs and alternating feet is developed. **Social-Emotional:** room for active breaks and adult helpers. An inclusive space.

Net Tower with ADA Stairs

MSC6419

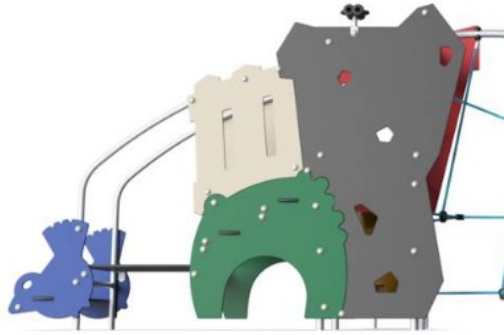

Panels of 19mm EcoCore™. EcoCore™ is a highly durable, eco friendly material, which is not only recyclable after use, but also consists of material produced from +95% recycled post consumer material from food packing waste.



All floors are made of High-Pressure Laminate HPL with a thickness 17.8mm and non skid surface texture according to EN 438-6. KOMPAN HPL has high wearing strength to ensure long lifetime in all climates.



Molded PE slides made with 33% post-consumer materials in different colors in one-piece design with a wall thickness of minimum 5mm. The PE is tested for UV stability and has excellent impact strength and it is usable within a large temperature span.

Item no. MSC641900-3717P

Installation Information

Max. fall height	193 cm
Safety surfacing area	38.9 m ²
Total installation time	14.0
Excavation volume	0.89 m ³
Concrete volume	0.09 m ³
Footing depth (standard)	90 cm
Shipment weight	413 kg
Anchoring options	In-ground ✓ Surface ✓

Warranty Information

EcoCore HDPE	Lifetime
Hot dip galvanised steel	Lifetime
HPL decks	15 years
Ropes & nets	10 years
Spare parts guaranteed	10 years

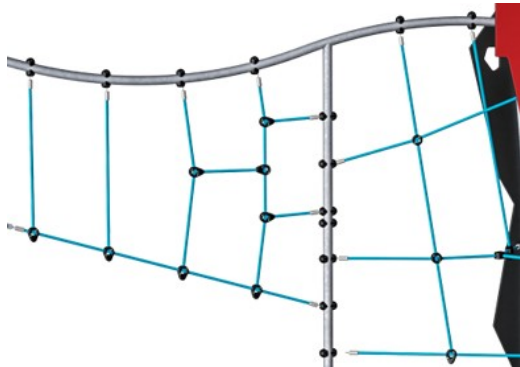

Ropes are made of UV-stabilized PP rope strands with inner steel cable reinforcement. Horizontal ropes are PUR coated to obtain good wear and tear resistance.



The steel surfaces are hot dip galvanised inside and outside with lead free zinc. The galvanisation has excellent corrosion resistance in outside environments and requires low maintenance.

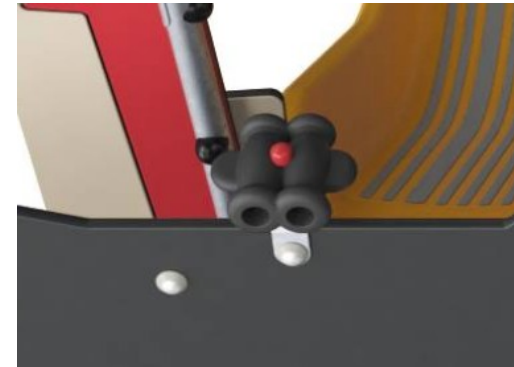

Binoculars are made of PUR. All components retain their properties in the temperature range of -30°C to 60°C. Material is UV stabilised.



Sustainability Data

MSC6419

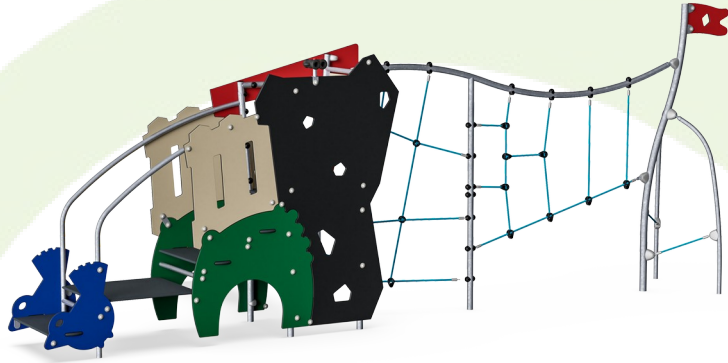

Cradle to Gate A1-A3	Total CO ₂ emission	CO ₂ e/kg	Recycled materials
	kg CO ₂ e	kg CO ₂ e/kg	%
MSC641900-3717P	791.17	2.37	48.56

The overall framework applied for these factors is the Environmental Product Declaration (EPD), which quantifies "environmental information on the life cycle of a product and enable comparisons between products fulfilling the same function" (ISO, 2006). This follows the structure and applies a Life-Cycle Assessment approach to the entire Product stage from raw material through manufacturing (A1-A3))

Kompan A/S
 C.F. Tietgens Boulevard 32C
 DK-5220 Odense SØ
 Denmark



Verification of CO₂ calculation of: Themed play systems



Data version no. 2023-10-05

The CO₂ calculation and data are in compliance with the principles of a carbon footprint impact according to the GHG protocol (Greenhouse Gas Protocol), Scope 3, cradle to gate related to all individual components in the product category: "Themed play systems" represented by item no.: MSC641100-3717P.

(Scope 3 emissions include emission sources in the upstream and downstream value chain).

Date: 30. October 2023 | Valid until: 30. October 2025

Verified by:

Julie Marie Vejsgaard Larsen, LCA & EPD Consultant

Verification based on report: Validation of CO₂ calculation of 9 categories of Kompan product line, version 1.0, prepared by: Bureau Veritas HSE, Denmark: Julie M. V. Larsen.

Publication date: 30. October 2023

By Bureau Veritas HSE
 www.bureauveritas.dk
 +45 7731 1000



Net Tower with ADA Stairs

MSC6419

* Max fall height | ** Total height | *** Safety surfacing area

* Max fall height | ** Total height

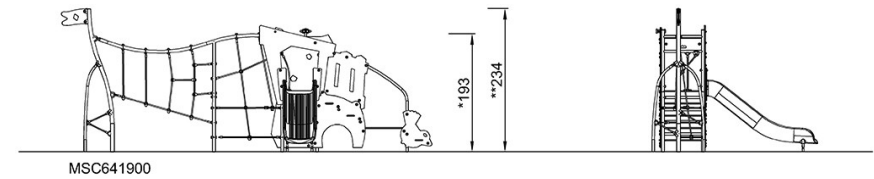
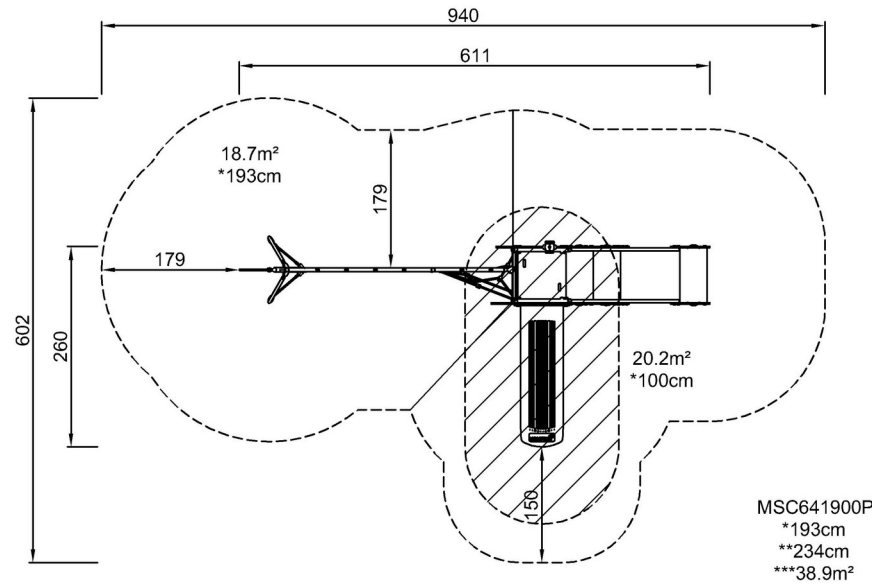

[Click to see TOP VIEW](#)

[Click to see SIDE VIEW](#)