

House Slide

MSC5402

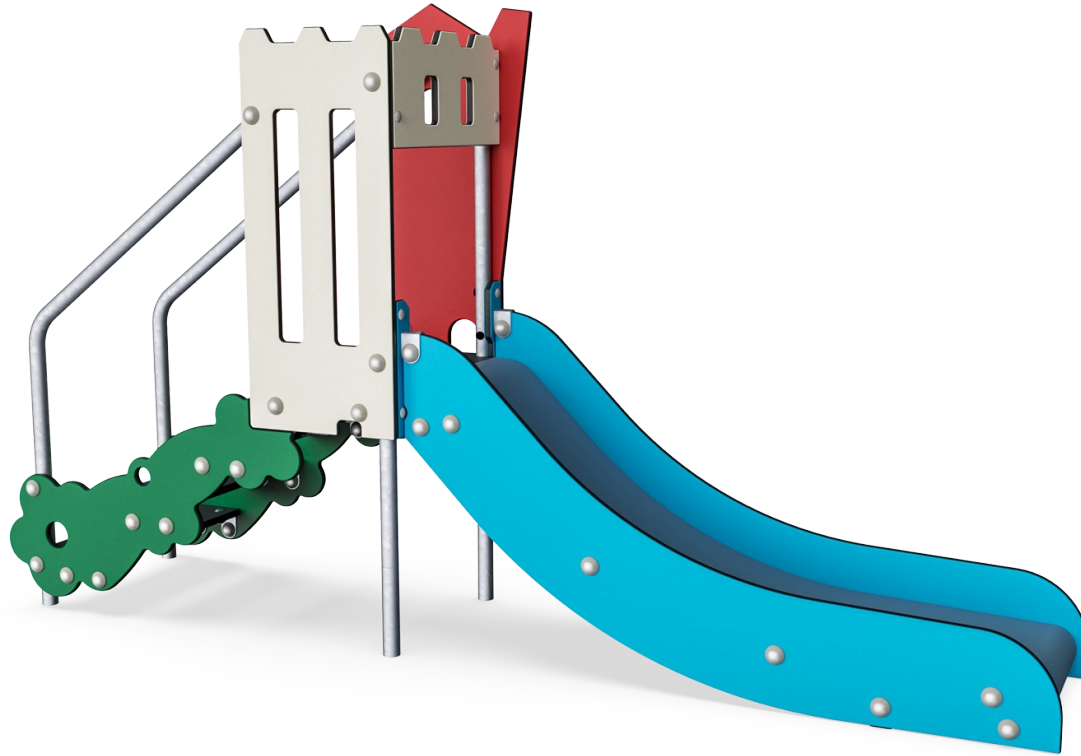

The House Slide is a favorite playground activity that attracts children to being active and playful in a thrilling way. The House Slide delights children and encourages them to be brave and enthusiastic on the playground, for hours of fun and active play. When children slide, they train their core muscles, sitting upright while sliding down. This stimulates their

trunk stability, important for avoiding back and neck pains – a growing problem in children due to sedentary lifestyles. Sliding additionally trains the child's sense of balance and spatial understanding. These skills are important in navigating the world securely. They are the fundament of all motor skills and thus a fundament in physical confidence in the child.

The house theme adds imagination to the climb and function as a story-telling prop, supporting language.

Item no. MSC540201-3417P	
General Product Information	
Dimensions LxWxH	244x55x142 cm
Age group	1+
Play capacity (users)	2
Color options	

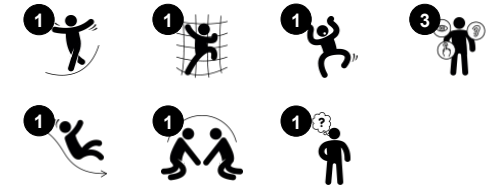

House Slide

MSC5402



Slide

Physical: sliding develops spatial awareness and a sense of balance. Furthermore, the core muscles are trained when sitting upright going down. **Social-Emotional:** empathy stimulated by turn-taking. **Cognitive:** young children develop their understanding of space, speed and distances when sliding down quickly.



Theme

Cognitive: suggests a theme and supports dramatic play, which stimulates language and communication skills.



Stairway

Physical: climbing the stairs supports cross coordination as well as arm and leg muscles. **Social-Emotional:** room for active breaks and adult helpers.

House Slide

MSC5402



Panels of 19mm EcoCore™. EcoCore™ is a highly durable, eco friendly material, which is not only recyclable after use, but also consists of material produced from +95% recycled post consumer material from food packing waste.

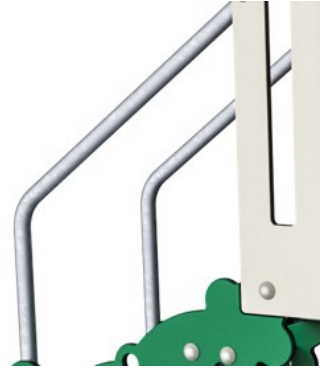

The steel surfaces are hot dip galvanised inside and outside with lead free zinc. The galvanisation has excellent corrosion resistance in outside environments and requires low maintenance.

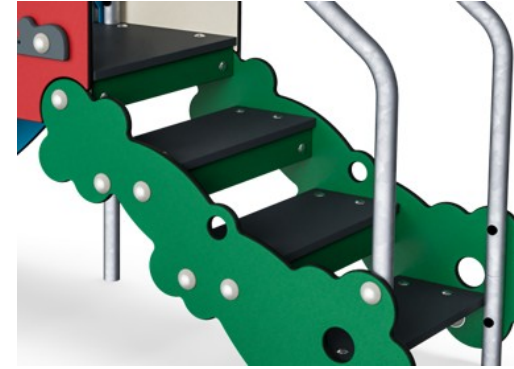

Steps are made of HPL with a thickness of 17,8mm with a very high wearing strength and a unique KOMPAN nonskid surface texture.

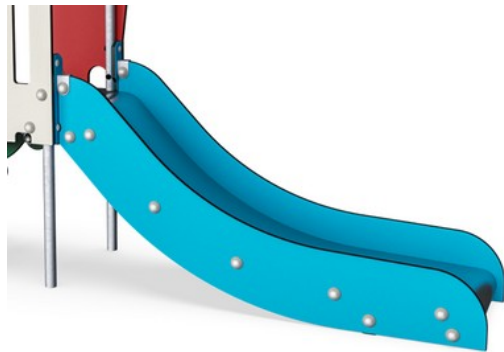

The slide bed can be chosen in different materials: Straight moulded PE or stainless steel slide bed t=2mm. Sides of the slides are made of EcoCore™.

Item no. MSC540201-3417P	
Installation Information	
Max. fall height	100 cm
Safety surfacing area	15.6 m ²
Total installation time	6.6
Excavation volume	0.17 m ³
Concrete volume	0.00 m ³
Footing depth (standard)	60 cm
Shipment weight	134 kg
Anchoring options	In-ground ✓ Surface ✓
Warranty Information	
EcoCore HDPE	Lifetime
Hot dip galvanised steel	Lifetime
PE slide	10 years
Spare parts guaranteed	10 years



Sustainability Data

MSC5402

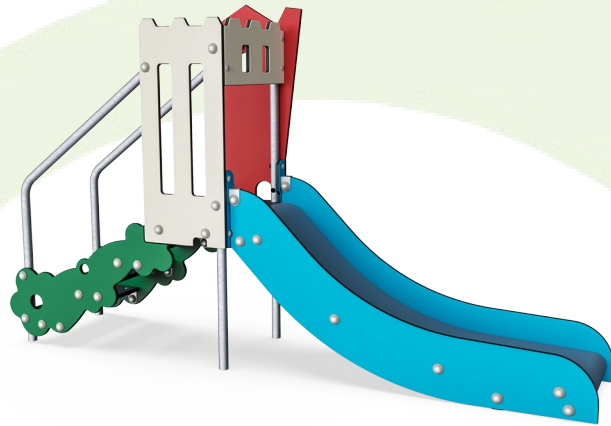

Cradle to Gate A1-A3	Total CO ₂ emission	CO ₂ e/kg	Recycled materials
	kg CO ₂ e	kg CO ₂ e/kg	%
MSC540201-3417P	164.84	2.06	57.06

The overall framework applied for these factors is the Environmental Product Declaration (EPD), which quantifies "environmental information on the life cycle of a product and enable comparisons between products fulfilling the same function" (ISO, 2006). This follows the structure and applies a Life-Cycle Assessment approach to the entire Product stage from raw material through manufacturing (A1-A3))

Kompan A/S
 C.F. Tietgens Boulevard 32C
 DK-5220 Odense SØ
 Denmark



Verification of CO₂ calculation of: Themed play systems



Data version no. 2023-10-05

The CO₂ calculation and data are in compliance with the principles of a carbon footprint impact according to the GHG protocol (Greenhouse Gas Protocol), Scope 3, cradle to gate related to all individual components in the product category: "Themed play systems" represented by item no.: MSC641100-3717P.

(Scope 3 emissions include emission sources in the upstream and downstream value chain).

Date: 30. October 2023 | Valid until: 30. October 2025

Verified by:

Julie Marie Vejsgaard Larsen, LCA & EPD Consultant

Verification based on report: Validation of CO₂ calculation of 9 categories of Kompan product line, version 1.0, prepared by: Bureau Veritas HSE, Denmark: Julie M. V. Larsen.

Publication date: 30. October 2023

By Bureau Veritas HSE
 www.bureauveritas.dk
 +45 7731 1000



House Slide

MSC5402

* Max fall height | ** Total height | *** Safety surfacing area

* Max fall height | ** Total height

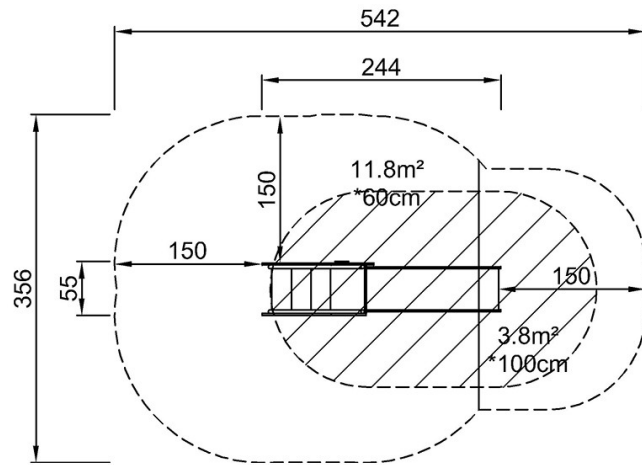

MSC540201P
*100cm
**142cm
***15.6m²

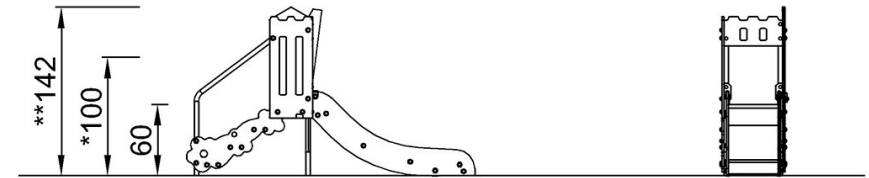

MSC540201

[Click to see TOP VIEW](#)

[Click to see SIDE VIEW](#)