

Stairs & Ramp

FSW229



Item no. FSW22900-0902

General Product Information

Dimensions LxWxH 101x415x163 cm

Age group 13+

Play capacity (users) 2

Colour options 



See KOMPAN Fit app for more



The stair and ramp resembles some common everyday obstacles. Walking on an inclining slope and overcoming stairs. The simplest use is just walking back and forth on the module, but with variations in the task, specific skills can be trained. For example focusing on balance by walking without hand support or focusing on strength and mobility by

deliberately using as long steps as possible. The stairs are available in two different versions: normal stairs or steep stairs. These can also be used for simple effective exercises like step-ups and lunges. The ability to walk safely on an inclining or declining slope is very important for the elderly. If body posture is not correctly aligned with the surface, the risk of falling is

increased. With support from the rails, this skill can be trained in a safe environment.

Stairs & Ramp

FSW229



The Four-steps are 900x280mm and have a height of 171mm.



The ramp is mounted under a 15 degree angle and has a length of 2300mm. The ramp is made from 5mm aluminium plate with an anti-slip pattern.

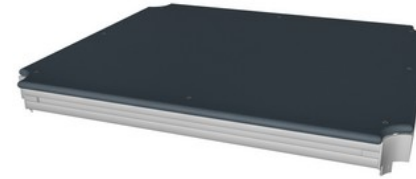

All decks are supported by unique designed aluminium profiles with multiple attachment options by usage of pressure moulded aluminum connectors. The HPL decks with a thickness of 17.8mm with a very high wearing strength and a unique KOMPAN nonskid surface texture.

Item no. FSW22900-0902

Installation Information

Max. fall height	69 cm
Safety surfacing area	15.3 m ²
Total installation time	11.4
Excavation volume	0.39 m ³
Concrete volume	0.12 m ³
Footing depth (standard)	90 cm
Shipment weight	398 kg
Anchoring options	In-ground ✓ Surface ✓

Warranty Information

EcoCore HDPE	Lifetime
Hot dip galvanised steel	Lifetime
HPL decks	15 years
Post	10 years
Spare parts guaranteed	10 years



The railing height is 930mm and the distance between the railing is 900mm. The material used for the railing is hot-dip galvanised steel ø38 mm, a great diameter for a good grip and wrist support.



The information sign is made of a PA6 (Polyamide) and shows the most relevant exercise and a QR code. When scanned the QR code will link to an animated illustration of the exercise and offers the possibility of downloading the KOMPAN sport & fitness App, which will provide a large amount of exercises and workouts.



Posts are made of Ø101.6 x 2mm, pre-galvanized carbon steel and powder coated, a great protection to all conditions.



Sustainability Data

FSW229



Cradle to Gate A1-A3	Total CO ₂ emission	CO ₂ e/kg	Recycled materials
	kg CO ₂ e	kg CO ₂ e/kg	%
FSW22900-0902	935.23	3.58	39.08

The overall framework applied for these factors is the Environmental Product Declaration (EPD), which quantifies "environmental information on the life cycle of a product and enable comparisons between products fulfilling the same function" (ISO, 2006). This follows the structure and applies a Life-Cycle Assessment approach to the entire Product stage from raw material through manufacturing (A1-A3))

Kompan A/S
C.F. Tietgens Boulevard 32C
DK-5220 Odense SØ
Denmark



Verification of CO₂ calculation of: Fitness



Data version no. 2023-10-05

The CO₂ calculation and data are in compliance with the principles of a carbon footprint impact according to the GHG protocol (Greenhouse Gas Protocol), Scope 3, cradle to gate related to all individual components in the product category: "Fitness" represented by item no.: FAZ10100-0900.

(Scope 3 emissions include emission sources in the upstream and downstream value chain).

Date: 30. October 2023 | Valid until: 30. October 2025

Verified by:

Julie Marie Vejsgaard Larsen, LCA & EPD Consultant

Verification based on report: Validation of CO₂ calculation of 9 categories of Kompan product line, version 1.0, prepared by: Bureau Veritas HSE, Denmark: Julie M. V. Larsen.

Publication date: 30. October 2023

By Bureau Veritas HSE
www.bureauveritas.dk
+45 7731 1000



Stairs & Ramp

FSW229

* Max fall height | ** Total height | *** Safety surfacing area

* Max fall height | ** Total height

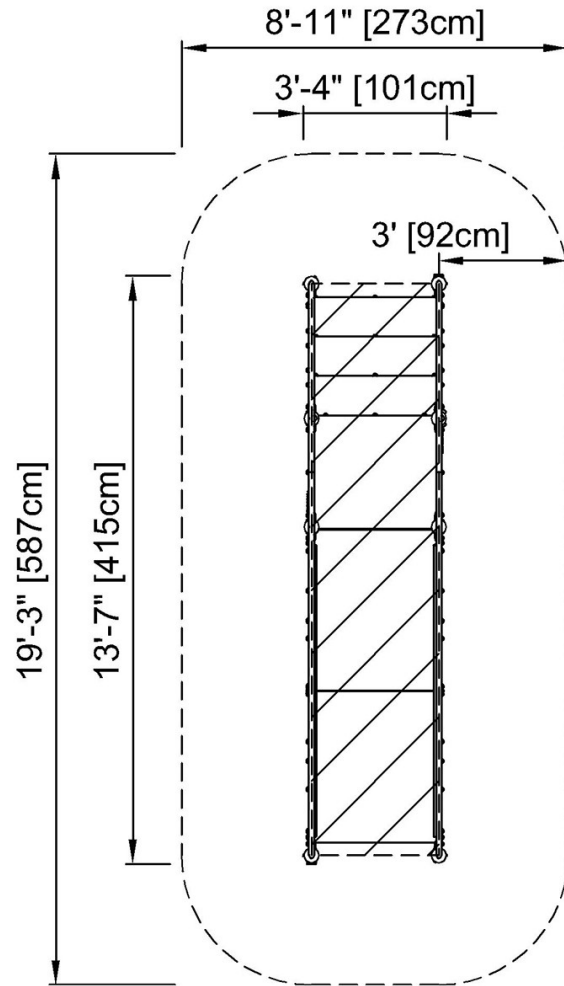

FSW22900
* 2'-3" / 69cm
** 5'-4" / 163cm
*** 165ft² / 15.3m²

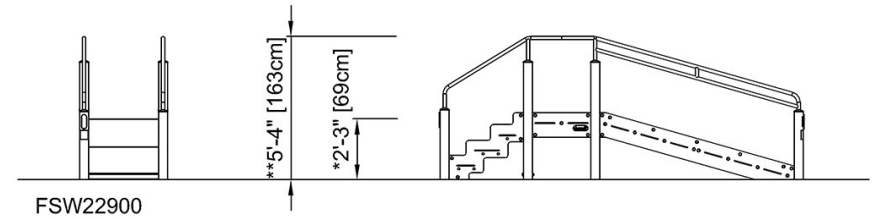

[Click to see TOP VIEW](#)

[Click to see SIDE VIEW](#)