

Butterfly, Physical

COR17510

Item no. COR175101-0403

General Product Information

Dimensions LxWxH	685x571x308 cm
Age group	5+
Play capacity (users)	22
Color options	

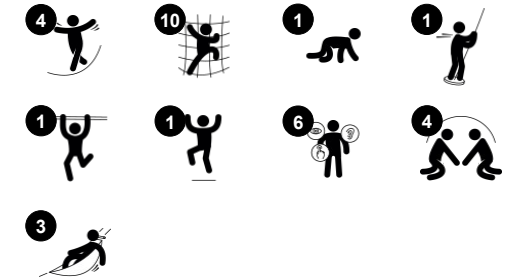

The elegantly curved Butterfly is a statement for climbing. With its twisted climbs, the Butterfly invites climbing try-outs again and again. Thanks to the transparency of the Butterfly nets, the children can see each other and communicate across the wings. And there are lots to talk about and try out: the twisted nets stimulate clever climbing and balancing

techniques, which stimulate the child's cross-coordination and proprioception, both important for precise movements and ultimately for moving confidently through the world. The visible heights add thrill. There are faster and slower ways across and up into the Butterfly: curved climbers add fast access to the top frame, and banister bars offer a fast glide to the

ground. At ground level, balance disks suspended in ropes add swaying balancing movements, standing or seated. The sense of balance is crucial to train, as it is fundamental for body control and concentration.

Butterfly, Physical

COR17510

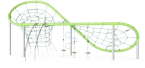

Large climbing net

Physical: the connected nets make climbers feel the movements of the other climbers, adding a dimension of fun and demanding concentration. All muscle groups are trained, as well as cross coordination. **Social-Emotional:** room for breaks for many and support cooperation and turn-taking skills.



Climbing pole

Physical: cross coordination and muscle strength are trained. **Social-Emotional:** turn-taking and cooperation.



Vertical climbing funnel

Physical: develops cross coordination and trains major muscles when climbing up or down. **Social-Emotional:** socializing and friendly competition when climbing up and down with friends.



Banister bars

Physical: coordination is supported when going down, as well as arm and core muscles. Landing strengthens bone density, which is built for life in childhood. **Social-Emotional:** turn-taking and risk-taking.



Ropes with rubber discs

Physical: children develop cross-body coordination and muscle strength when stepping onto the disc and climbing the rope. Their sense of balance is trained when swaying gently. The sense of balance is important for instance for being able to sit still. **Social-Emotional:** socializing and turn-taking when deciding who should sit here.

Butterfly, Physical

COR17510



Fully coloured EPDM rubber discs with smooth surface. The moulded EPDM surrounds a hot dip galvanised steel core that ensures both the stability of the discs and durable fixation to the rope.

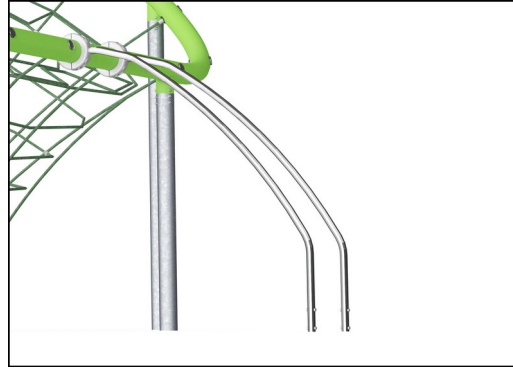

The stainless steel activities are made of high quality stainless steel. The steel is glass blasted after manufacturing to ensure a smooth gliding surface.

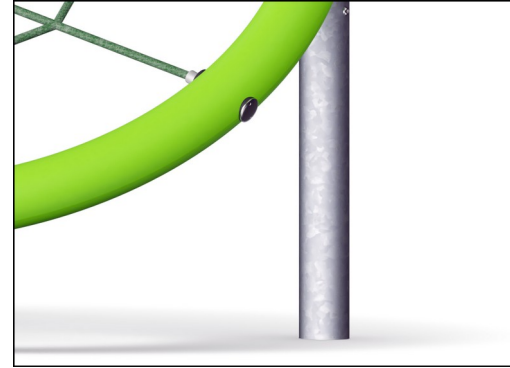

Colored steel components have a base of hot dip galvanization and a powder coated top finish. This provides an ultimate corrosion resistance in all climates around the world. Other steel surfaces are hot dip galvanized inside and outside with lead free zinc.



Ropes of UV-stabilized PES rope strands with inner steel cable reinforcement. The polyester yarn is made from +95% post-consumer materials and is inductively melted onto each strand. The ropes are highly wear- and vandalism-resistant and can be replaced at site if needed.



Corocord 'S' clamps are used as universal connections in Corocord products. 8mm stainless steel rods with rounded edges are pressed around the ropes with a special hydraulic press, making them the ideal connector: safe, durable and vandalism-proof, all while allowing the typical movement of rope play structures.



The rope is fixed to the large steel pipe by a unique KOMPAN designed tightening solution. It consists of inner and outer nylon (PA6) bushings that guides the rope to an outside threaded aluminum part that tighten the rope.

Item no. COR175101-0403

Installation Information

Max. fall height	300 cm
Safety surfacing area	58.8 m ²
Total installation time	22.0
Excavation volume	16.80 m ³
Concrete volume	5.89 m ³
Footing depth (standard)	60 cm
Shipment weight	1,610 kg
Anchoring options	In-ground ✓

Warranty Information

Hot dip galvanised steel	Lifetime
Painted toplayer	10 years
Ropes & nets	10 years
Spare parts guaranteed	10 years
Stainless steel components	Lifetime



Sustainability Data

COR17510

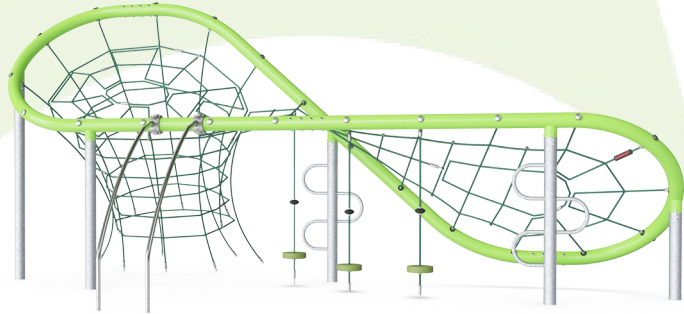

Cradle to Gate A1-A3	Total CO ₂ emission	CO ₂ e/kg	Recycled materials
	kg CO ₂ e	kg CO ₂ e/kg	%
COR175101-0403	2,935.54	2.79	49.57

The overall framework applied for these factors is the Environmental Product Declaration (EPD), which quantifies "environmental information on the life cycle of a product and enable comparisons between products fulfilling the same function" (ISO, 2006). This follows the structure and applies a Life-Cycle Assessment approach to the entire Product stage from raw material through manufacturing (A1-A3))

Kompan A/S
C.F. Tietgens Boulevard 32C
DK-5220 Odense SØ
Denmark



Verification of CO₂ calculation of: Corocord



Data version no. 2023-10-05

The CO₂ calculation and data are in compliance with the principles of a carbon footprint impact according to the GHG protocol (Greenhouse Gas Protocol), Scope 3, cradle to gate related to all individual components in the product category: "Corocord" represented by item no.: COR314011-1101.

(Scope 3 emissions include emission sources in the upstream and downstream value chain).

Date: 30. October 2023 | Valid until: 30. October 2025

Verified by:

Julie Marie Vejsgaard Larsen, LCA & EPD Consultant

Verification based on report: Validation of CO₂ calculation of 9 categories of Kompan product line, version 1.0, prepared by: Bureau Veritas HSE, Denmark: Julie M. V. Larsen.

Publication date: 30. October 2023

By Bureau Veritas HSE
www.bureauveritas.dk
+45 7731 1000



Butterfly, Physical

COR17510

* Max fall height | ** Total height | *** Safety surfacing area

* Max fall height | ** Total height

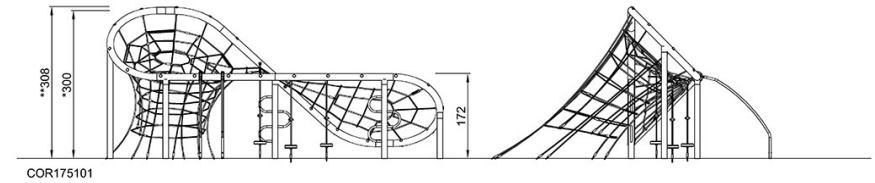
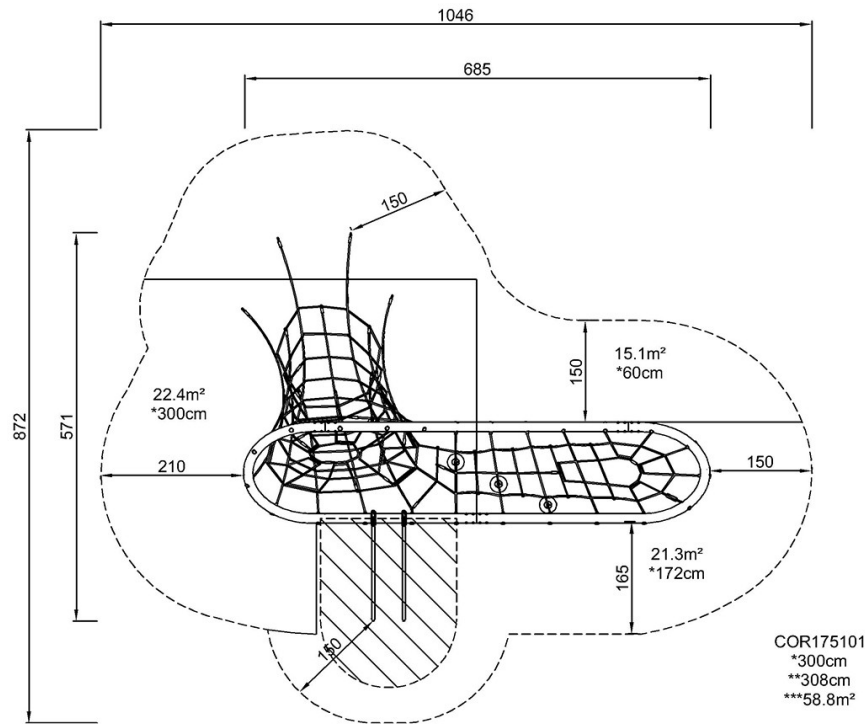

[Click to see TOP VIEW](#)

[Click to see SIDE VIEW](#)