

# Hideaway Tree

PCM52821

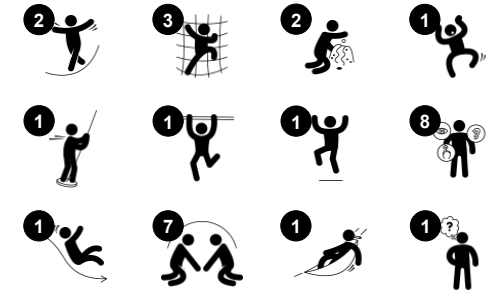

Item no. PCM52821-0901	
General Product Information	
Dimensions LxWxH	526x437x420 cm
Age group	2+
Play capacity (users)	21
Colour options	



The Hideaway Tree offers a richness of play events which attract children to play over and over. The beautiful tree offers varied climbing, dramatic and social play options: children can access the platform with play panels and treehouse either by taking the stairs or the climbing wall. The platform offers numerous tactile play details in panels, which train young

children's logical thinking skills and inspire dramatic play. Climbing up here is a favourite play activity. Climbing supports children's cross-coordination skills and builds fundamental movement skills that positively affect cross-modal perception and learning. Gliding down the fireman's pole is a great thrill, and it trains children's sense of balance and

space, as well as their muscles. Under the play platform a hammock invites socialising and offers a gently swaying break from climbing, for individual play or social play.



# Hideaway Tree

PCM52821



## Hammock

**Physical:** coordination and sense of balance when swaying. **Social-Emotional:** meeting, pushing friends gently back and forth, turn-taking. **Cognitive:** for toddlers cause and effect understanding.



## Theme

**Cognitive:** suggests a theme and supports dramatic play, which stimulates language and communication skills.



## Slide

**Physical:** sliding develops spatial awareness and a sense of balance. Furthermore, the core muscles are trained when sitting upright going down. **Social-Emotional:** empathy stimulated by turn-taking. **Cognitive:** young children develop their understanding of space, speed and distances when sliding down quickly.

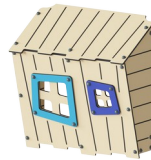

## Tree House

**Social-Emotional:** offers a great meeting point to be together with friends. The height adds a feeling of achievement to meet friends here.



## Bats and Spider panel

**Social-Emotional:** invites cooperation due to the two-sidedness. **Cognitive:** children can leave their mark, placing the bats in different positions. **Cognitive:** the tangle theme stimulates language and communication skills.

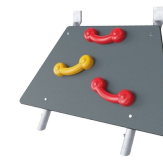

## Rock climber

**Physical:** supports cross coordination and leg, arm and hand strength. **Social-Emotional:** the inclination makes climbing feel secure, especially for younger children.



## Fireman's pole

**Physical:** coordination is supported when going down, as well as arm and core muscles. Landing strengthens bone density, which is built for life in early childhood. **Social-Emotional:** turn-taking and risk-taking. **Cognitive:** young children develop their understanding of space, speed and distances when gliding down fast.

# Hideaway Tree

PCM52821



Panels of 19mm EcoCore™. EcoCore™ is a highly durable, eco friendly material, which is not only recyclable after use, but also consists of material produced from +95% recycled post consumer material from food packing waste.



Main posts with hot dip galvanized steel footing are available in different materials: Pre-galvanized inside and outside with powder coated top finish steel posts. Lead free aluminum with color anodized top finish. TexMade posts of 95% post-consumer recycled PE and textile waste.



All decks are supported by unique designed low-carbon aluminum profiles with multiple attachment options. The grey colored molded decks are made of 75% post-consumer waste PP material with a non-skid pattern and texture surface.

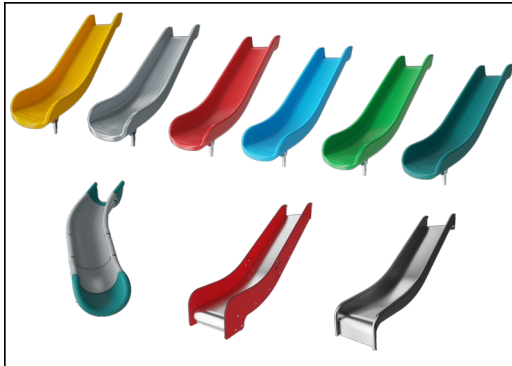

The slides can be chosen in six different colors and three materials: Straight or curved one-piece molded PE slides, made from 33% recycled post-consumer materials in different colours. Combined EcoCore™ sides and stainless-steel. Full stainless steel in one piece design for more vandalism proof solutions.

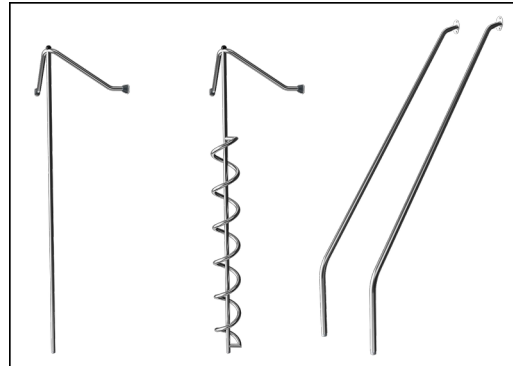

The stainless-steel activities are made of high-quality stainless steel. The steel is cleaned by a total pickling process after manufacturing to ensure a smooth and clean gliding surfaces.



KOMPAN GreenLine versions are designed with ultimate environmentally friendly materials with lowest possible CO2e emission factor. TexMade post, EcoCore™ panels of 95% post-consumer recycled waste and molded PP decks.

Item no. PCM52821-0901

### Installation Information

Max. fall height	118 cm
Safety surfacing area	34.9 m <sup>2</sup>
Total installation time	34.1
Excavation volume	0.74 m <sup>3</sup>
Concrete volume	0.02 m <sup>3</sup>
Footing depth (standard)	90 cm
Shipment weight	1,348 kg
Anchoring options	Surface ✓ In-ground ✓

### Warranty Information

EcoCore HDPE	Lifetime
Post	10 years
PP Decks	10 years
Spare parts guaranteed	10 years
Stainless steel components	Lifetime

# Sustainability Data

PCM52821



Cradle to Gate A1-A3	Total CO <sub>2</sub> emission	CO <sub>2</sub> e/kg	Recycled materials
	kg CO <sub>2</sub> e	kg CO <sub>2</sub> e/kg	%
<b>PCM52821-0901</b>	1,396.82	1.46	75.15

The overall framework applied for these factors is the Environmental Product Declaration (EPD), which quantifies "environmental information on the life cycle of a product and enable comparisons between products fulfilling the same function" (ISO, 2006). This follows the structure and applies a Life-Cycle Assessment approach to the entire Product stage from raw material through manufacturing (A1-A3))

**Kompan A/S**  
 C.F. Tietgens Boulevard 32C  
 DK-5220 Odense SØ  
 Denmark



## Verification of CO<sub>2</sub> calculation of: Play systems



Data version no. 2023-10-05

The CO<sub>2</sub> calculation and data are in compliance with the principles of a carbon footprint impact according to the GHG protocol (Greenhouse Gas Protocol), Scope 3, cradle to gate related to all individual components in the product category: "Play systems" represented by item no.: PCM200321-0950.

(Scope 3 emissions include emission sources in the upstream and downstream value chain).

**Date: 30. October 2023 | Valid until: 30. October 2025**

Verified by:

Julie Marie Vejsgaard Larsen, LCA & EPD Consultant

Verification based on report: Validation of CO<sub>2</sub> calculation of 9 categories of Kompan product line, version 1.0, prepared by: Bureau Veritas HSE, Denmark: Julie M. V. Larsen.

**Publication date: 30. October 2023**

By Bureau Veritas HSE  
 www.bureauveritas.dk  
 +45 7731 1000



# Hideaway Tree

PCM52821

\* Max fall height | \*\* Total height | \*\*\* Safety surfacing area

\* Max fall height | \*\* Total height

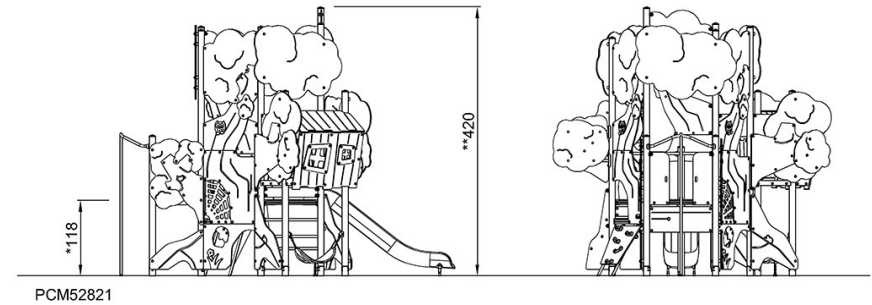
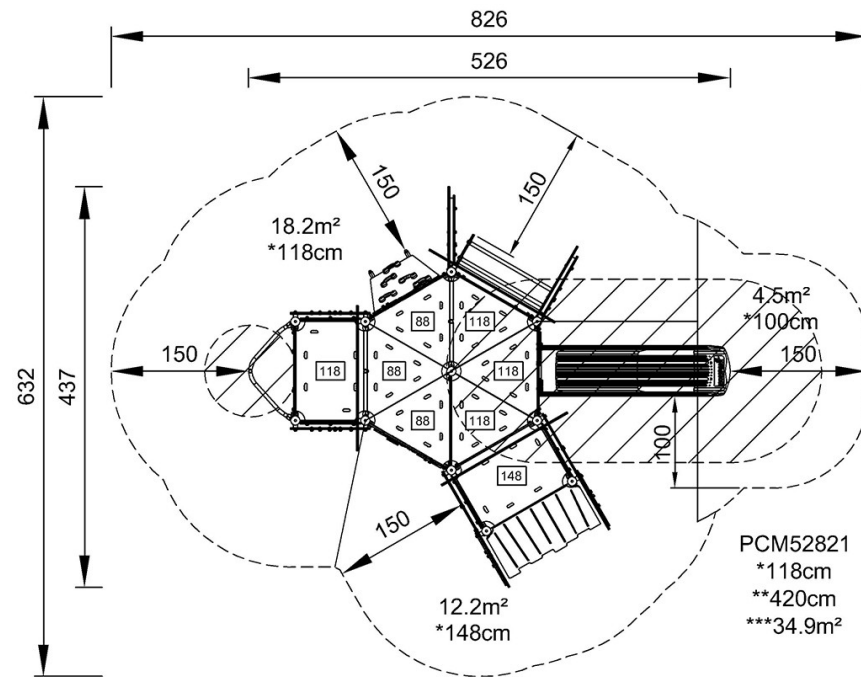

[Click to see TOP VIEW](#)

[Click to see SIDE VIEW](#)