

Play Panel 2 - Music, Classic

PCM003121

KOMPAN
Let's play

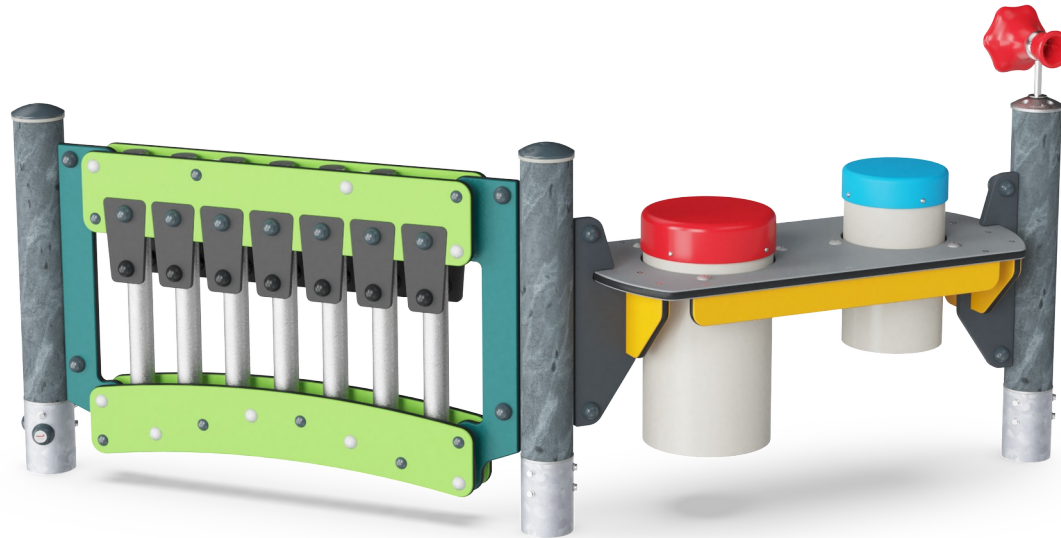

Item no. PCM003121-0950

General Product Information

Dimensions LxWxH	198x96x92 cm
Age group	6m - 5
Play capacity (users)	7
Colour options	



The Music Play Panel 2 attracts children immensely with its colorful combinations of rhythm, sounds and tones. They will come back again and again to be part of creative play, on their own or with friends and teachers. The music pipes offer sensory variations with a tonal sound outcome. Children train the hand-eye coordination which is crucial to control of

movement and e.g. handwriting. The black rubber flaps can be plunked, or pipes beaten and tunes created. This trains logical as well as creative thinking and invites cooperation and social play. The Percussion Panel is an immense play invitation for children: The drums can be played alone or together. There is room for many users to congregate around them.

This encourages social interaction and co-creation when drumming rhythms and singing along. It also stimulates cognition and creativity as children create rules and rhythms together or individually.

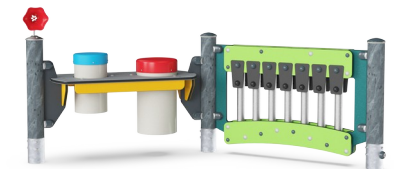

Play Panel 2 - Music, Classic

PCM003121



Megaphone

Social-Emotional: inspires communication and turn-taking skills. **Cognitive:** distortion of sound evokes curiosity and stimulates an understanding of cause and effect.

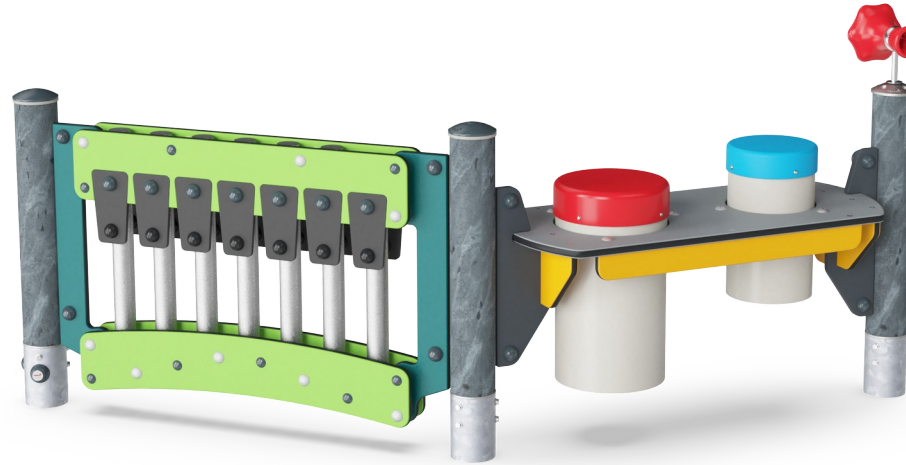

Music tubes

Social-Emotional: invite social interaction and co-creation for more children, on both sides. **Cognitive:** understanding of cause and effect when striking tubes. **Creative:** the creation of different intensity and tonality stimulates creative skills.



Two sides

Social-Emotional: invites cooperation and communication. The low height and the transparency of the panel makes interaction possible between the two sides.



Drums

Social-Emotional: cooperation and co-creation, parallel and group play. **Cognitive:** cause and effect understanding when creating sounds, supporting a sense of rhythm, that is essential for pre-reading skills. **Creative:** creating and leaving a mark with sound.



Tonality

Cognitive: creative thinking when combining tones into tunes. **Creative:** composing new tonal combinations stimulates creativity.



Rubber flaps

Social-Emotional: the two rows of flaps invite cooperation and co-creation. **Cognitive:** cause and effect understanding when discovering sound from flaps hitting tubes.

Play Panel 2 - Music, Classic

PCM003121



Main posts with hot dip galvanized steel footing are available in different materials: Pressure impregnated pine wood posts. Pre-galvanized inside and outside with powder coated top finish steel posts. Lead free aluminum with color anodized top finish. Greenline TexMade posts of 95% post-consumer recycled PE and textile waste.



The Xylophone music panel consist of HDPE material in 19mm EcoCore™ made with +95% recycled post-consumer material from e.g., food packing waste in both core and colorful outer layer. The pipes are made of die cast aluminum specifically alloyed for outdoor environments. The percussion panel consist of 2 Conga Drums with PP tubes and top in colored ABS.

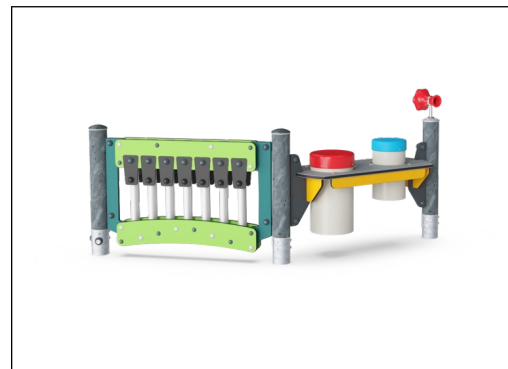

KOMPAN GreenLine versions are designed with ultimate environmentally friendly materials with lowest possible CO2e emission factor such as EcoCore™ panels of +95% post consumer recycled ocean waste.

Item no. PCM003121-0950	
Installation Information	
Max. fall height	0 cm
Safety surfacing area	0.0 m ²
Total installation time	4.6
Excavation volume	0.05 m ³
Concrete volume	0.00 m ³
Footing depth (standard)	85 cm
Shipment weight	94 kg
Anchoring options	In-ground ✓ Surface ✓
Warranty Information	
EcoCore HDPE	Lifetime
Hot dip galvanised steel	Lifetime
Movable parts	2 years
Post	10 years
Spare parts guaranteed	10 years

Elevated activities 0	Accessible elevated activities	Accessible ground level activities	Accessible ground level play types
Present	0	3	1
Required	0	3	1

CSA
Z614
compliant

Sustainability Data

PCM003121

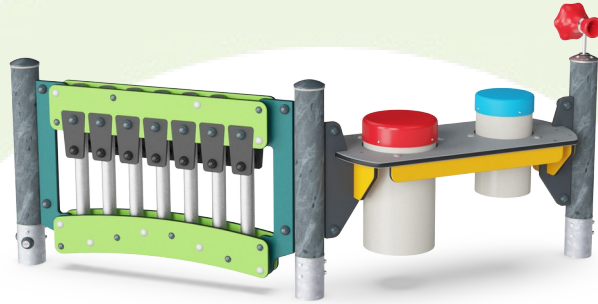

Cradle to Gate A1-A3	Total CO ₂ emission	CO ₂ e/kg	Recycled materials
	kg CO ₂ e	kg CO ₂ e/kg	%
PCM003121-0950	140.81	2.00	63.91
PCM003121-0901	174.06	2.74	50.74

The overall framework applied for these factors is the Environmental Product Declaration (EPD), which quantifies "environmental information on the life cycle of a product and enable comparisons between products fulfilling the same function" (ISO, 2006). This follows the structure and applies a Life-Cycle Assessment approach to the entire Product stage from raw material through manufacturing (A1-A3))

Kompan A/S
C.F. Tietgens Boulevard 32C
DK-5220 Odense SØ
Denmark



Verification of CO₂ calculation of: Themed play systems



Data version no. 2023-10-05

The CO₂ calculation and data are in compliance with the principles of a carbon footprint impact according to the GHG protocol (Greenhouse Gas Protocol), Scope 3, cradle to gate related to all individual components in the product category: "Themed play systems" represented by item no.: MSC641100-3717P.

(Scope 3 emissions include emission sources in the upstream and downstream value chain).

Date: 30. October 2023 | Valid until: 30. October 2025

Verified by:

Julie Marie Vejsgaard Larsen, LCA & EPD Consultant

Verification based on report: Validation of CO₂ calculation of 9 categories of Kompan product line, version 1.0, prepared by: Bureau Veritas HSE, Denmark: Julie M. V. Larsen.

Publication date: 30. October 2023

By Bureau Veritas HSE
www.bureauveritas.dk
+45 7731 1000



Play Panel 2 - Music, Classic

PCM003121

* Max fall height | ** Total height | *** Safety surfacing area

* Max fall height | ** Total height

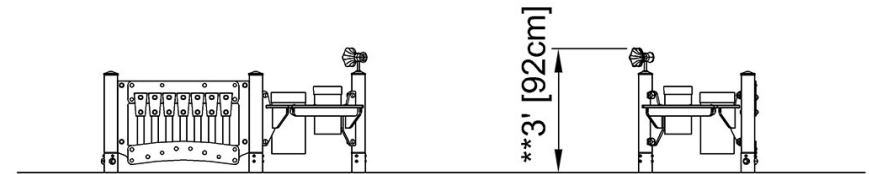
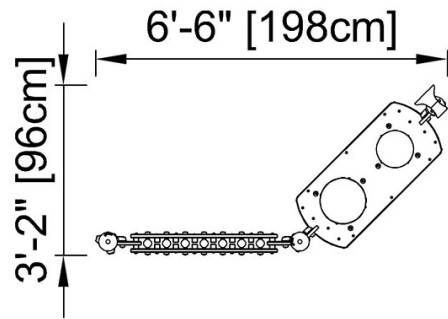

PCM003121

PCM003121
** 3'-0" / 92cm

[Click to see TOP VIEW](#)

[Click to see SIDE VIEW](#)