

Large Octa Net with Sky Cabin

COR10320

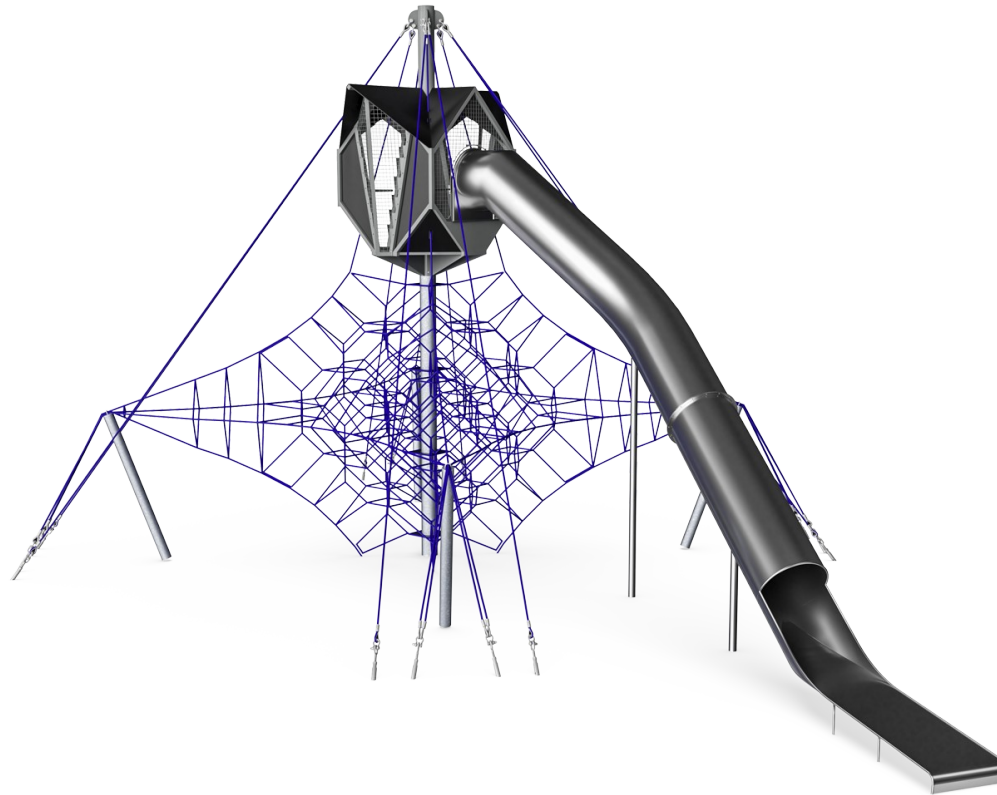

Item no. COR103201-1002	
General Product Information	
Dimensions LxWxH	1386x887x730 cm
Age group	5+
Play capacity (users)	41
Colour options	

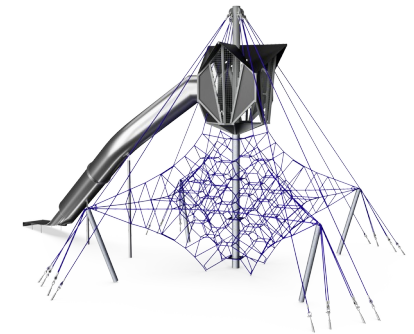
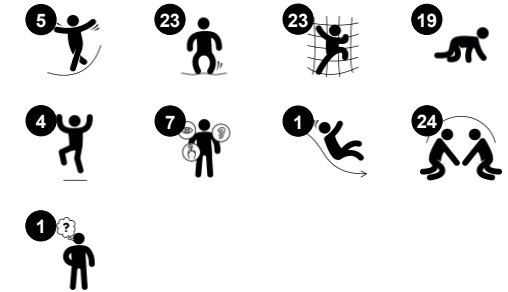

This intriguing play space will immediately attract children to play and explore the many physical challenges it has to offer. The carefully designed Octa Net challenges children to explore the space by using their muscles for a climb to the top, and the reward of the Sky cabin and the thrilling slide down, to start the adventure over again. The repeated climbing

and sliding will strengthen physical endurance, as well as aerobic and cardio capacity. The variety of routes to take up and around the Octa Net helps children to develop their logical thinking skills in conjunction with their physical skills. The large capacity climbing net provides opportunities for children to socialize and strengthen relationships through play. The sky

cabin provides a place for rest as well as social interaction that will inspire hours of joyful physical activity.

Large Octa Net with Sky Cabin

COR10320

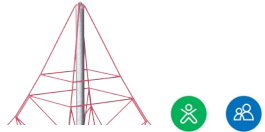

Highest rungs

Physical: spatial awareness is supported, arm muscles when holding tight. **Social-Emotional:** children develop courage, self-confidence, consideration and turn-taking, all important life skills.

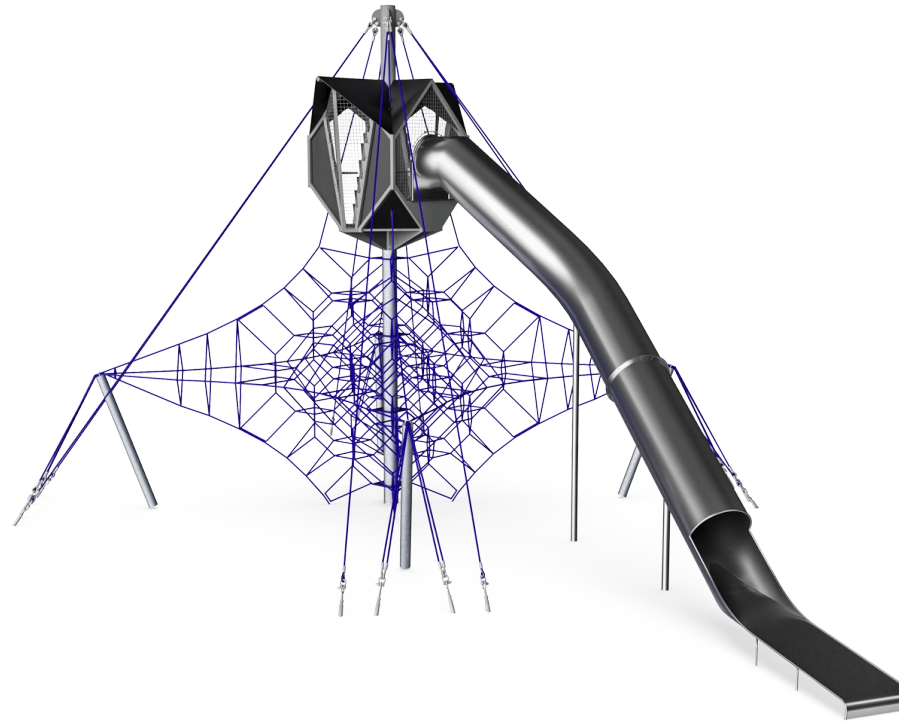

Sturdy, middle rung

Physical: the bounce develops the sense of balance, which is important for skills such as sitting still. The upper body muscles are trained when hanging from the arms. Bone density is developed when jumping down. **Social-Emotional:** many children can stand or sit on the rung together, cooperating and feeling the movements of the other children moving. This develops consideration and cooperation.



Sky cabin

Physical: being up high develops spatial awareness and sense of balance. **Social-Emotional:** a destination and meeting point up high adds social interaction as well as thrill and great views.

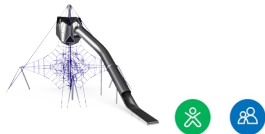

Big meshes

Physical: the big meshes allow for climbing and crawling, supporting proprioception, cross coordination and spatial awareness. Climbing here takes muscle strength, pushing and pulling arms to get upwards. **Social-Emotional:** allow more children being seated together, sharing.



Long tube slide

Physical: sliding develops spatial awareness and the sense of balance. **Social-Emotional:** the height ensures extra speed and thrill. Empathy stimulated by turn-taking and consideration of others. Feeling of security when stopping on extra long slide mouth.

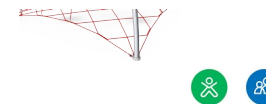

Sturdy, lower rungs

Physical: the stiff bounce of the lower rung supports balance and coordination as well as strengthens bone density when jumping down. Hanging from the arms trains back and upper body muscles, supporting good posture. These are a growing concern for children due to sedentary lifestyles. **Social-Emotional:** great meeting point allowing socializing.



Bouncy net meshes

Physical: agility, balance and coordination as well as spatial awareness are supported when bouncing, climbing and sitting in the net. Children use muscle strength of arms, legs and core, and build bone density when jumping down. **Social-Emotional:** the bouncing, swaying net appeals to empathy and cooperation. **Cognitive:** physical memory, logical thinking, concentration.

Large Octa Net with Sky Cabin

COR10320



Ropes of UV-stabilized PES rope strands with inner steel cable reinforcement. The polyester yarn is made from +95% post-consumer materials and is inductively melted onto each strand. The ropes are highly wear-and vandalism-resistant and can be replaced at site if needed.



Corocord 'S' clamps are used as universal connections in Corocord products. 8mm stainless steel rods with rounded edges are pressed around the ropes with a special hydraulic press, making them the ideal connector: safe, durable and vandalism-proof, all while allowing the typical movement of rope play structures.



The aluminium swages of the net are double conical with rounded ends and are as small as safety allows. The overall net design aims at keeping metal parts within the net to an absolute minimum, both in size and number, in order to provide the best possible rope climbing experience.



Corocord membranes consist of friction-proof rubberized material of conveyor belt quality with excellent UV resistance. Tested and compliant with REACH requirements for PAH. Embedded is a four-layered armoring made of woven polyester. The armoring and the two surface layers result in a total thickness of 7.5 mm.

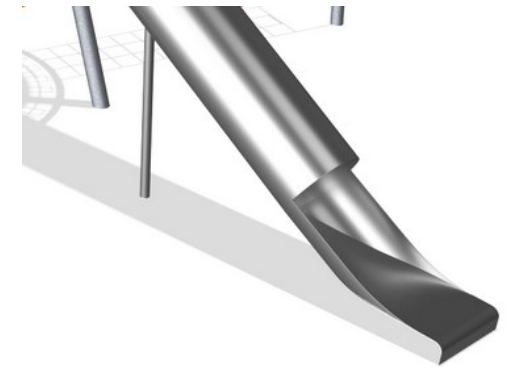

The stainless steel components are made of high quality stainless steel in compliance with global playground standards. The steel is glass blasted after manufacturing to ensure a smooth gliding surface.



Through KOMPAN Variant Team, you can choose between additional 7 rope colours and customize your solution. The assortment is a wide span of colours ranking from elegant and expressive black or natural and toned-down hemp colour, to a range of attractive and eye-catching signal colours.

Item no. COR103201-1002	
Installation Information	
Max. fall height	225 cm
Safety surfacing area	121.4 m ²
Total installation time	50.0
Excavation volume	17.76 m ³
Concrete volume	10.70 m ³
Footing depth (standard)	100 cm
Shipment weight	3,551 kg
Anchoring options	In-ground ✓
Warranty Information	
Aluminium clamps	10 years
Corocord rope	10 years
Membrane	2 years
S-Clamps	10 years
Spare parts guaranteed	10 years



Sustainability Data

COR10320

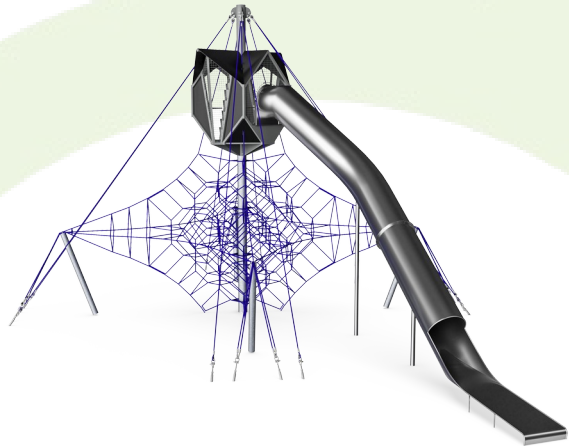

Cradle to Gate A1-A3	Total CO ₂ emission	CO ₂ e/kg	Recycled materials
	kg CO ₂ e	kg CO ₂ e/kg	%
COR103201-1002	8,455.19	2.88	51.45

The overall framework applied for these factors is the Environmental Product Declaration (EPD), which quantifies "environmental information on the life cycle of a product and enable comparisons between products fulfilling the same function" (ISO, 2006). This follows the structure and applies a Life-Cycle Assessment approach to the entire Product stage from raw material through manufacturing (A1-A3))

Kompan A/S
 C.F. Tietgens Boulevard 32C
 DK-5220 Odense SØ
 Denmark



Verification of CO₂ calculation of: Corocord



Data version no. 2023-10-05

The CO₂ calculation and data are in compliance with the principles of a carbon footprint impact according to the GHG protocol (Greenhouse Gas Protocol), Scope 3, cradle to gate related to all individual components in the product category: "Corocord" represented by item no.: COR314011-1101.

(Scope 3 emissions include emission sources in the upstream and downstream value chain).

Date: 30. October 2023 | Valid until: 30. October 2025

Verified by:

Julie Marie Vejsgaard Larsen, LCA & EPD Consultant

Verification based on report: Validation of CO₂ calculation of 9 categories of Kompan product line, version 1.0, prepared by: Bureau Veritas HSE, Denmark: Julie M. V. Larsen.

Publication date: 30. October 2023

By Bureau Veritas HSE
 www.bureauveritas.dk
 +45 7731 1000



Large Octa Net with Sky Cabin

COR10320

* Max fall height | ** Total height | *** Safety surfacing area

* Max fall height | ** Total height

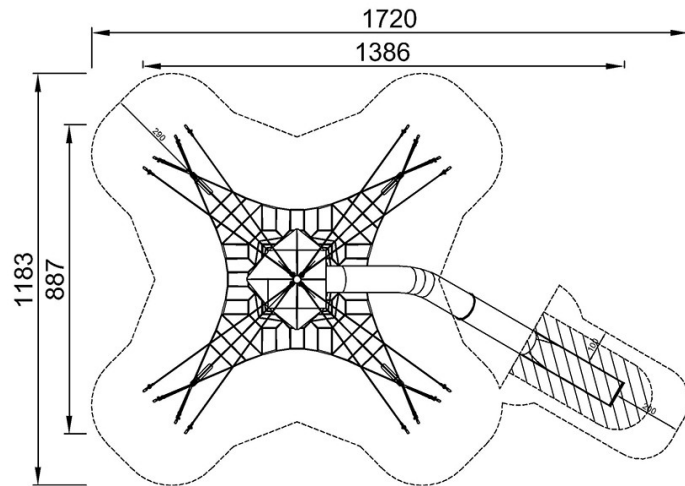

COR103201
*225cm
**730cm
***121.4m²

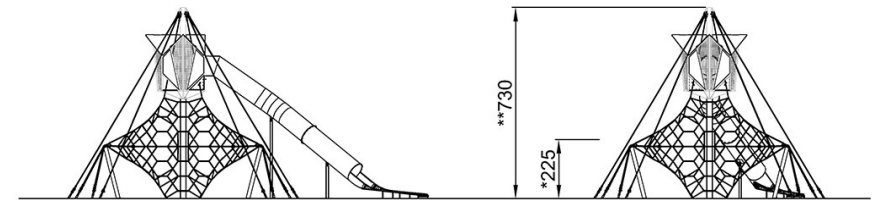

COR103201

[Click to see TOP VIEW](#)

[Click to see SIDE VIEW](#)