

# BLOQX 1

BLX4101

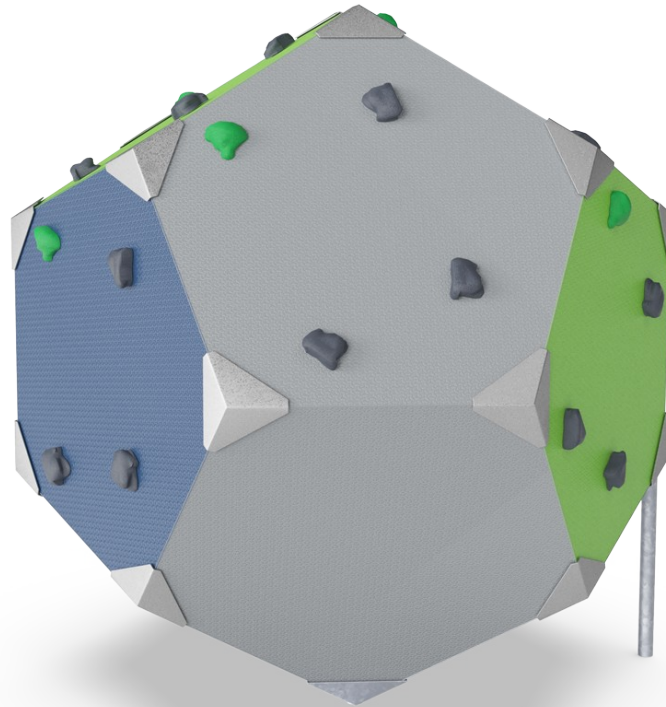

Item no. BLX410102-3717	
<b>General Product Information</b>	
Dimensions LxWxH	183x215x205 cm
Age group	8+
Play capacity (users)	8
Colour options	

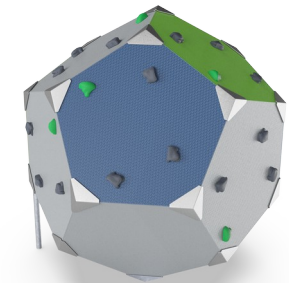
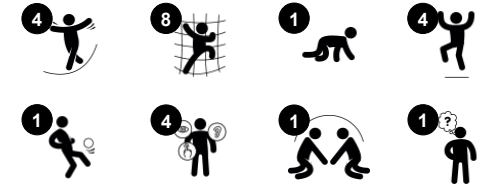

The iconic, geometric shaped BLOQX™ 1 encourages climbing and meeting particularly for teenagers and older children. With its sculptural look and professional climbing grips, BLOQX™ invites scalable climbing challenges and games. The design allows room for socializing and exchange with its ridges and valleys. The possibility of climbing, crawling

and balancing at your own speed make the BLOQX™ a safe option for children at different climbing levels. Due to its versatility, children will enjoy BLOQX™ and return for more. The varied grip and panel positions help to develop muscle strength and motor skills: cross-body coordination, proprioception and spatial awareness, having a positive impact on

concentration skills and social-emotional skills such as consideration, which is used when children climb and meet together on the BLOQX™.

# BLOQX 1

BLX4101

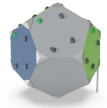

## Inclined panels

**Physical:** sense of balance when seated for breaks, and proprioception. Bone density when jumping down. Bone density is built up in youth to last the rest of your life. **Social-Emotional:** meeting points from where to help other children. Turn-taking and helping out are common activities on the BLOQX™.

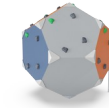
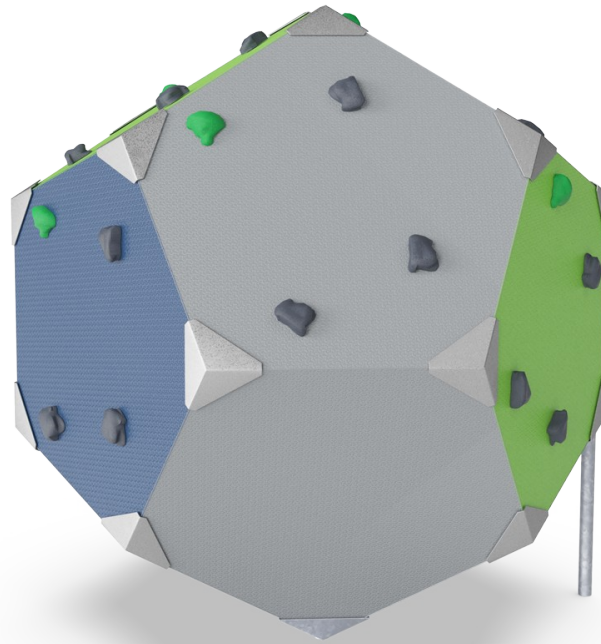

## Climbing grips grid

**Cognitive:** logical thinking when figuring out routes and memorizing position of grips you can't see when climbing.



## Climbing grips

**Physical:** dexterity and cross-body coordination, sense of space, all important in navigating the body in space. Pushing, pulling and using fingers, arms, legs and core, strengthen the muscles.

# BLOQX 1

BLX4101



High pressure moulded PP climbing panels with excellent impact strength and usable within a large temperature span. The panel are made from 75% post-consumer recycled materials in bright colors. Teal color is made from 75% ocean waste. The outside surface has an integrated pattern and surface texture that is dirt repellent.



Die-casted corner brackets of high quality lead free aluminium. The corner brackets have nicely rounded edges and countersunk stainless steel screws. For sunny environments the corner bracket can be supplied with optional powder coating which reduced the heat absorption of the brackets.

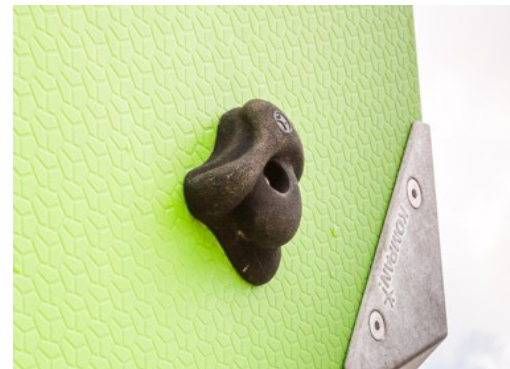

Climbing Grips are KOMPAN customized design, based on professionally designed climbing grips for optimal play value. The base material is polyester. There are two colours of climbing grips (green & black) and three on each panel. They are rotation secured by a steel pin.



The steel surfaces are hot dip galvanised inside and outside with lead free zinc. The galvanisation has excellent corrosion resistance in outside environments and requires low maintenance.



The cubes are supported by a unique designed footing system that secures the correct positioning of the cubes.

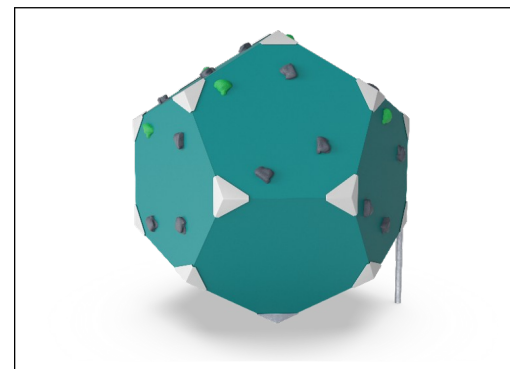

Greenline Bloqx products are built of molded PP panels which consist of 75% recycled post consumer ocean waste and 25% virgin material. The panels are designed with a unique pattern that provides a non-skid surface texture. GreenLine ensures the lowest possible CO2e emission factor.

Item no. BLX410102-3717

### Installation Information

Max. fall height	205 cm
Safety surfacing area	19.8 m <sup>2</sup>
Total installation time	9.1
Excavation volume	0.46 m <sup>3</sup>
Concrete volume	0.20 m <sup>3</sup>
Footing depth (standard)	90 cm
Shipment weight	252 kg
Anchoring options	In-ground ✓ Surface ✓

### Warranty Information

Climbing grips	10 years
Climbing panels (PP)	10 years
Corner brackets	10 years
Hot dip galvanised steel	Lifetime
Spare parts guaranteed	10 years



# Sustainability Data

BLX4101

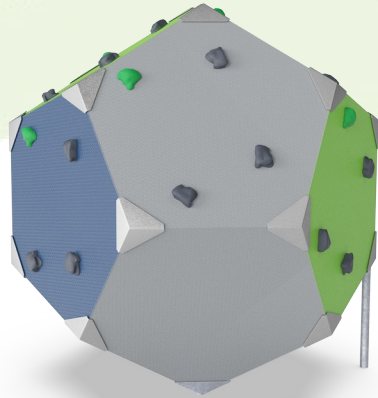

Cradle to Gate A1-A3	Total CO <sub>2</sub> emission	CO <sub>2</sub> e/kg	Recycled materials
	kg CO <sub>2</sub> e	kg CO <sub>2</sub> e/kg	%
<b>BLX410102-3717</b>	290.37	1.69	63.42

The overall framework applied for these factors is the Environmental Product Declaration (EPD), which quantifies "environmental information on the life cycle of a product and enable comparisons between products fulfilling the same function" (ISO, 2006). This follows the structure and applies a Life-Cycle Assessment approach to the entire Product stage from raw material through manufacturing (A1-A3))

**Kompan A/S**  
 C.F. Tietgens Boulevard 32C  
 DK-5220 Odense SØ  
 Denmark



## Verification of CO<sub>2</sub> calculation of: Challengers & Climbers



Data version no. 20213-10-05

The CO<sub>2</sub> calculation and data are in compliance with the principles of a carbon footprint impact according to the GHG protocol (Greenhouse Gas Protocol), Scope 3, cradle to gate related to all individual components in the product category: "Challenger & Climbers" represented by item no.: GXY941032-3717.

(Scope 3 emissions include emission sources in the upstream and downstream value chain).

**Date: 30. October 2023 | Valid until: 30. October 2025**

Verified by:

Julie Marie Vejsgaard Larsen, LCA & EPD Consultant

Verification based on report: Validation of CO<sub>2</sub> calculation of 9 categories of Kompan product line, version 1.0, prepared by: Bureau Veritas HSE, Denmark: Julie M. V. Larsen.

**Publication date: 30. October 2023**

By Bureau Veritas HSE  
 www.bureauveritas.dk  
 +45 7731 1000



# BLOQX 1

BLX4101

\* Max fall height | \*\* Total height | \*\*\* Safety surfacing area

\* Max fall height | \*\* Total height

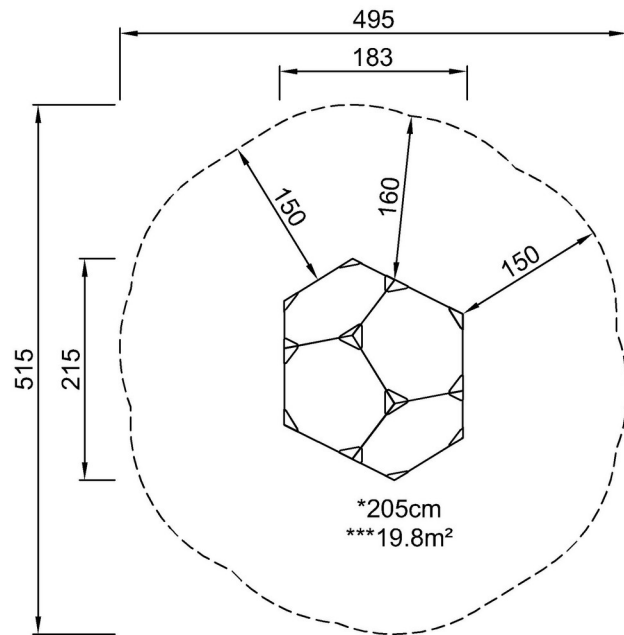

BLX410102  
\*205cm  
\*\*205cm  
\*\*\*19.8m<sup>2</sup>

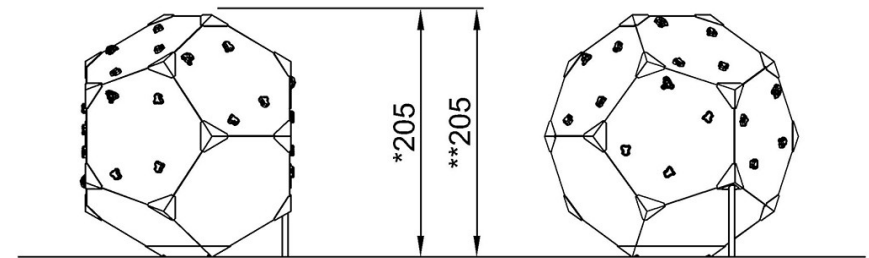

BLX410102

[Click to see TOP VIEW](#)

[Click to see SIDE VIEW](#)