

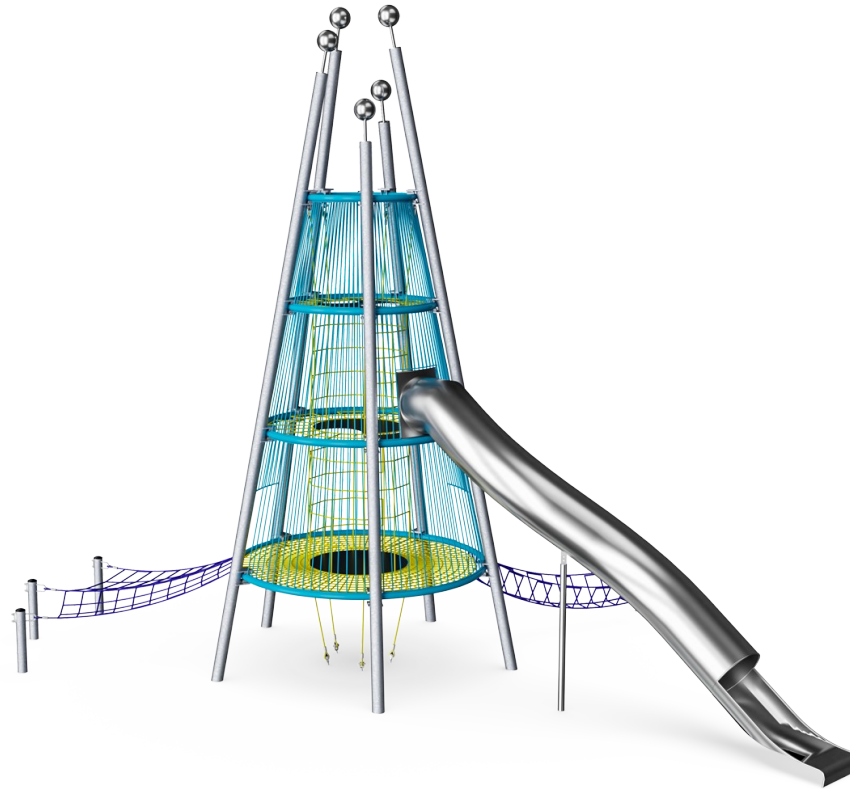

Giant Rope Play Tower

COR29700



Item no. COR297001-1202	
General Product Information	
Dimensions LxWxH	1050x811x915 cm
Age group	5 - 12
Play capacity (users)	65
Colour options	

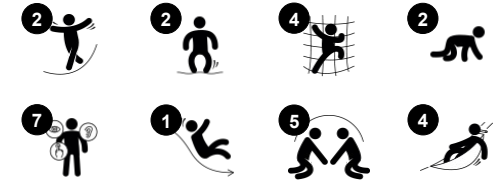

The Giant Rope Play Tower takes play to new heights. The children will explore the unit again and again, wanting to go up high and whizz down the slide as fast as they can. A swaying climb up to the first platform of the play tower calls for a break. The bouncy membrane gives children the opportunity to bounce developing their balance skills. The next platform offers a

thrilling slide down. Apart from being great fun, this trains children's sense of balance, important for instance for sitting still on a chair. The next level is exhilarating: a view from 9 meters high. Apart from the awe of this, it trains the child's spatial awareness, which again is important for instance for judging distances in the street. The Giant Rope Play Tower is so

much more than mere thrill, it helps challenge and develop children's physical and social skills.

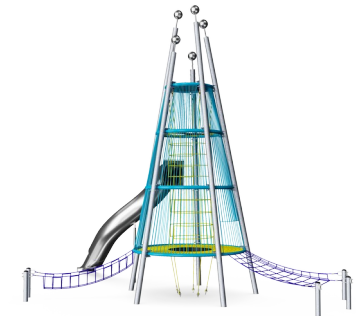

Giant Rope Play Tower

COR29700



Height

Social-Emotional: children develop courage and self-regulation when being up high. This positively affects self-confidence.

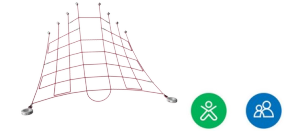
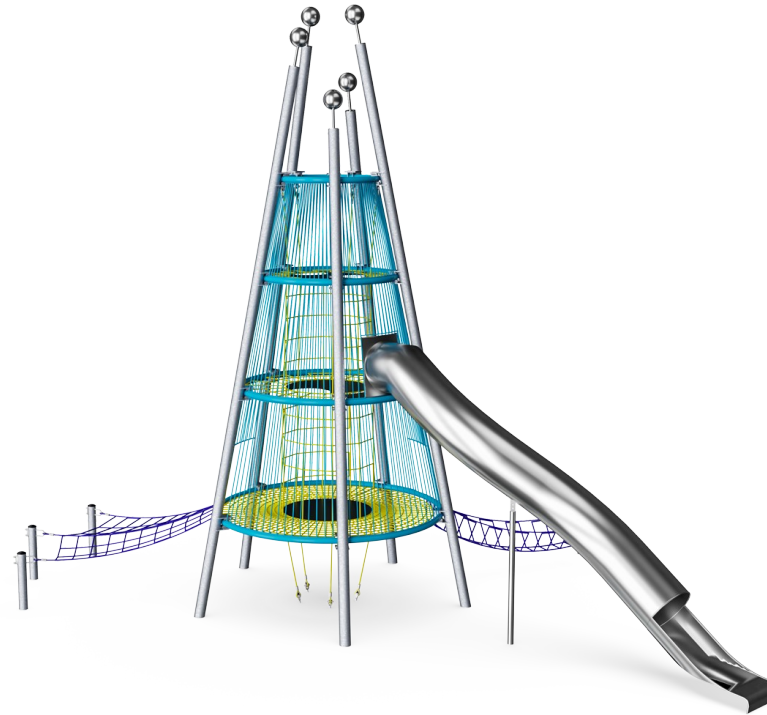

Inclined net

Physical: the inclined net supports the upward climbing movement of the body, training cross-body coordination and muscle strength. **Social-Emotional:** the meshes allow for more children being seated or lying together, sharing.



Tube slide

Physical: sliding develops spatial awareness and a sense of balance. Furthermore, the core muscles are trained when sitting upright going down. **Social-Emotional:** thrill when going down fast. Empathy stimulated by turn-taking.



Internal climbing net

Physical: children develop cross-body coordination and muscle strength. The big meshes allow for climbing and crawling through, training proprioception and spatial awareness. **Social-Emotional:** the big meshes allow for more children being seated together, sharing.

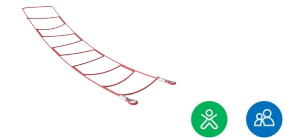

Wobble bridge

Physical: sense of balance and training of cross coordination. Important for other skills such as being able to sit still. **Social-Emotional:** turn-taking and helping others when climbing up.

Giant Rope Play Tower

COR29700



Ropes of UV-stabilized PES rope strands with inner steel cable reinforcement. The polyester yarn is made from +95% post-consumer materials and is inductively melted onto each strand. The ropes are highly wear-and vandalism-resistant and can be replaced at site if needed.



Corocord 'S' clamps are used as universal connections in Corocord products. 8mm stainless steel rods with rounded edges are pressed around the ropes with a special hydraulic press, making them the ideal connector: safe, durable and vandalism-proof, all while allowing the typical movement of rope structures.



The aluminium swages of the net are double conical with rounded ends and are as small as safety allows. The overall net design aims at keeping metal parts within the net to an absolute minimum, both in size and number, in order to provide the best possible rope climbing experience.



Corocord membranes consist of friction-proof rubberized material of conveyor belt quality with excellent UV resistance. Tested and compliant with REACH requirements for PAH. Embedded is a four-layered armoring made of woven polyester. The armoring and the two surface layers result in a total thickness of 7.5 mm.



The metal parts are made of high quality steel, hot dip galvanised inside and outside with leadfree zinc. On the outside, there is an additional layer of powder coating. This ensures both excellent corrosion resistance and colourful design expression.

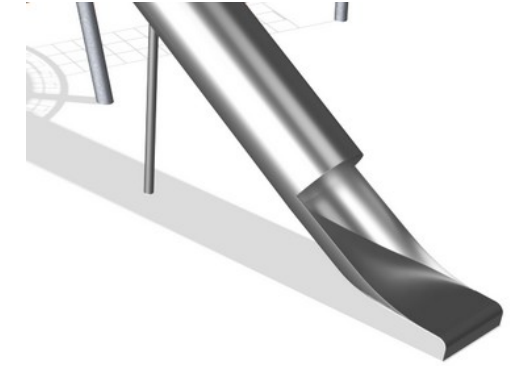

The stainless steel components are made of high quality stainless steel in compliance with global playground standards. The steel is glass blasted after manufacturing to ensure a smooth gliding surface.

Item no. COR297001-1202	
Installation Information	
Max. fall height	150 cm
Safety surfacing area	107.6 m ²
Total installation time	103.0
Excavation volume	19.94 m ³
Concrete volume	13.90 m ³
Footing depth (standard)	120 cm
Shipment weight	5,581 kg
Anchoring options	In-ground <input checked="" type="checkbox"/>
Warranty Information	
Corocord rope	10 years
Hot dip galvanised steel	Lifetime
Membrane	2 years
S-Clamps	10 years
Spare parts guaranteed	10 years

Elevated activities 0	Accessible elevated activities	Accessible ground level activities	Accessible ground level play types
Present	0	4	2
Required	0	2	2

**CSA
Z614**
compliant

Sustainability Data

COR29700

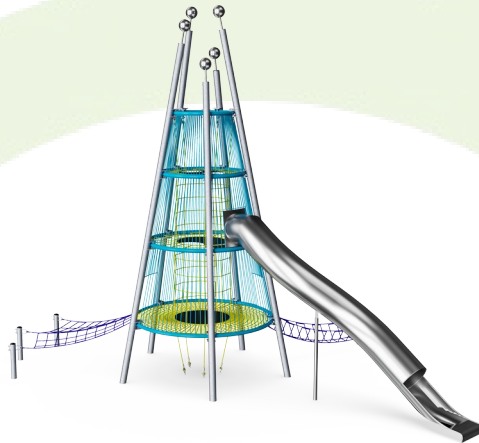

Cradle to Gate A1-A3	Total CO ₂ emission	CO ₂ e/kg	Recycled materials
	kg CO ₂ e	kg CO ₂ e/kg	%
COR297001-1202	11,174.89	2.78	51.24

The overall framework applied for these factors is the Environmental Product Declaration (EPD), which quantifies "environmental information on the life cycle of a product and enable comparisons between products fulfilling the same function" (ISO, 2006). This follows the structure and applies a Life-Cycle Assessment approach to the entire Product stage from raw material through manufacturing (A1-A3))

Kompan A/S
 C.F. Tietgens Boulevard 32C
 DK-5220 Odense SØ
 Denmark



Verification of CO₂ calculation of: Corocord



Data version no. 2023-10-05

The CO₂ calculation and data are in compliance with the principles of a carbon footprint impact according to the GHG protocol (Greenhouse Gas Protocol), Scope 3, cradle to gate related to all individual components in the product category: "Corocord" represented by item no.: COR314011-1101.

(Scope 3 emissions include emission sources in the upstream and downstream value chain).

Date: 30. October 2023 | Valid until: 30. October 2025

Verified by:

Julie Marie Vejsgaard Larsen, LCA & EPD Consultant

Verification based on report: Validation of CO₂ calculation of 9 categories of Kompan product line, version 1.0, prepared by: Bureau Veritas HSE, Denmark: Julie M. V. Larsen.

Publication date: 30. October 2023

By Bureau Veritas HSE
 www.bureauveritas.dk
 +45 7731 1000



Giant Rope Play Tower

COR29700

* Max fall height | ** Total height | *** Safety surfacing area

* Max fall height | ** Total height

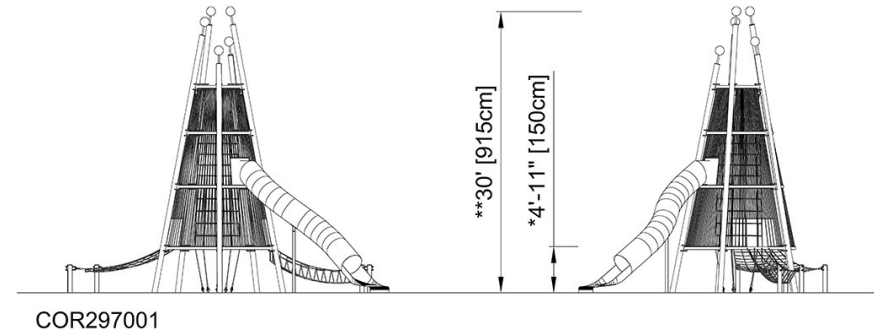
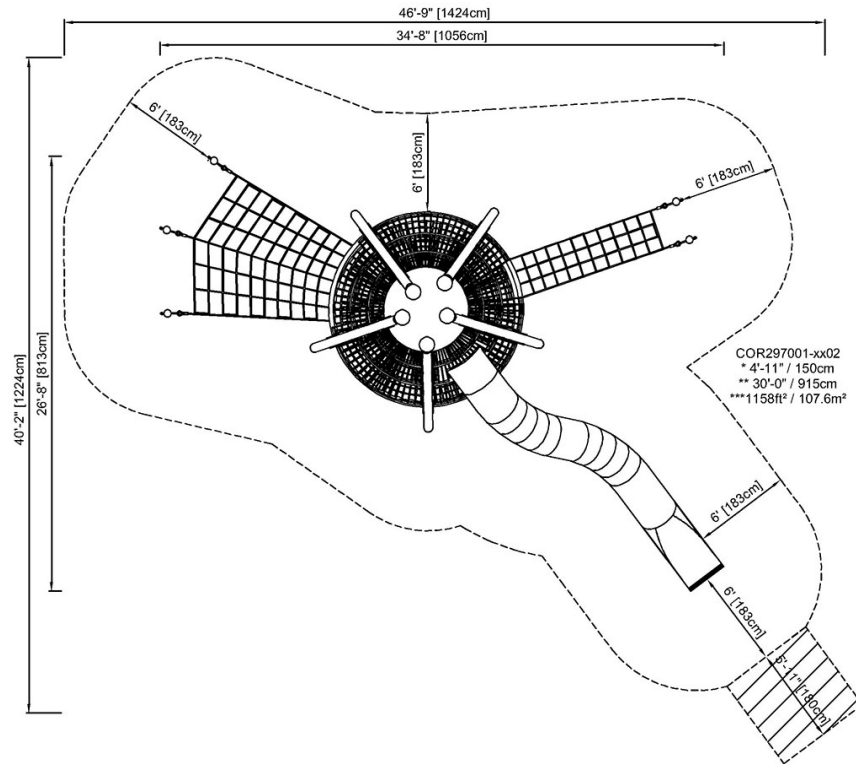

[Click to see TOP VIEW](#)

[Click to see SIDE VIEW](#)