

**463

*221

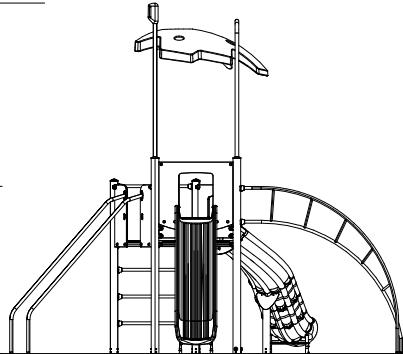

PCE111922
1:100