

# Wooden Rope Climber L

KPW250501

**KOMPANI**



Varenr. KPW250501-0901

## Generel produktinformation

Dimensioner LxBxH	491x272x282 cm
Alder	4+
Antal brugere	16
Farvemuligheder	●

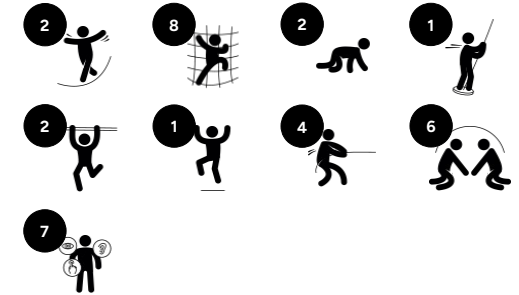

The Wooden Rope Climber immediately attracts children to the dense activity hub. Thanks to the varied climbing activities and route opportunity, all children have a chance of doing something. The fireman's pole provides a thrilling destination. The openness in design also invites conversation and social interaction across the Climber. This supports children's

socio-emotional development. With its combination of activities, the Climbing Structure stimulates children's cross-coordination, strength and bone density. All of these abilities are built for life in childhood.

# Wooden Rope Climber L

KPW250501

KOMPANI®



## Klatrenet

**Fysiske evner:** her udvikles krydskoordinering og muskelstyrke, som børn klatrer. De store masker giver mulighed for at klatre og kravle igennem, der understøtter rumlig bevidsthed og proprioception. **Social-emotionelle evner:** de store masker tillader børn at sidde sammen og snakke.

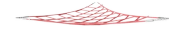

## Horizontal net

**Fysiske evner:** her udvikles krydsordination og rumlig bevidsthed, som børn klatrer. **Social-emotionelle evner:** et mødested til social samvær og pauser.



## Stige

**Fysiske evner:** her understøttes krydsordination og hånd-øje-koordination når børn klatrer på stigen. Her bruger de især ben- og armmuskulatur. **Social-emotionelle evner:** her lærer børn at skiftes og samarbejde.



## Støttende håndgreb

**Fysiske evner:** håndgrebene giver støtte til de mindre selvsikre klatrere. Træk sig selv op styrker overkropps muskler.



## Balancebom

**Fysiske evner:** træner balancen der er grundlæggende for alle andre motoriske færdigheder. Balancen gør det muligt at navigere trygt og sikkert. **Social-emotionelle evner:** opfordrer børnene til at skiftes og forhandle når man skal forbi hinanden. Der er også plads til at tage et hvil.



## Brandmandsstangen

**Fysiske evner:** her understøttes koordination og muskelopbygning, som børn glider ned. Når børn lander styrker det deres knogletæthed. **Social-emotionelle evner:** børnene lærer at skiftes og tage risici. **Kognitive evner:** små børn udvikler deres forståelse af rum, hastighed og afstand, som de glider ned.

# Wooden Rope Climber L

KPW250501

**KOMPANI**

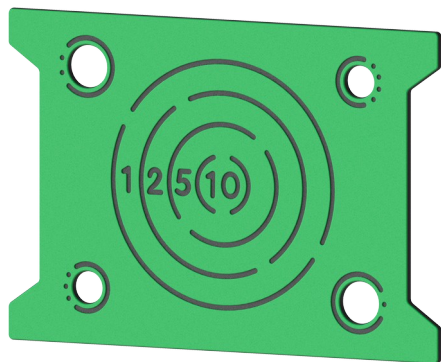

Paneler af 19 mm EcoCore™. EcoCore™ er et meget holdbart materiale, som ikke kun kan genanvendes efter brug, men som også består af materiale, der er produceret af >95 % genanvendt materiale fra fødevareemballageaffald.



Hovedtårnets stolper fås i to materialetyper: Stolper af europæisk fyrretræ, trykimprægneret klasse 3 i henhold til EN335 (svarende til NTR klasse AB). Aluminiumsstolpe t=2 mm med anodiseret overfladebehandling. Basismateriale EN AW-6060 T66.

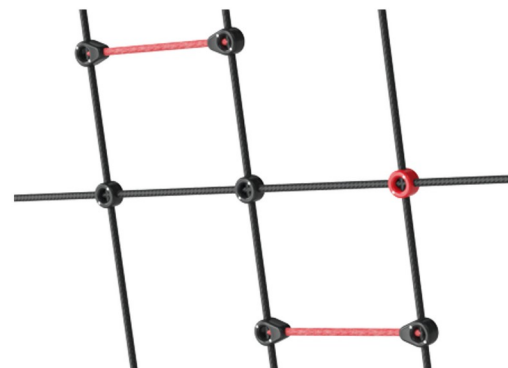

Reb af UV-stabiliserede PES-rebtråde med indvendig stålkabelforstærkning. Polyester garnet er fremstillet af >95 % genanvendte materialer og er induktivt smeltet på hver tråd.

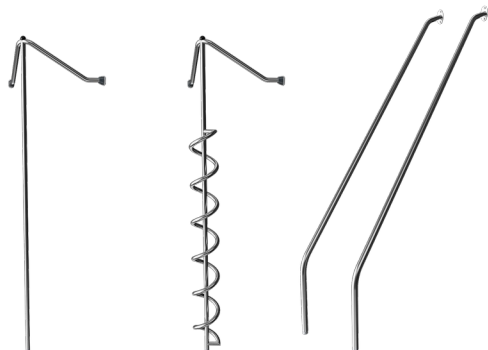

Aktiviteterne er fremstillet i rustfrit stål af høj kvalitet. Stålet rengøres ved en bejdsningsproces efter fremstillingen for at sikre en glat og ren overflade.

Varenr. KPW250501-0901

## Installationsinformation

Maks. faldhøjde	148 cm
Faldområde	31,8 m <sup>2</sup>
Installationstid (timer)	10,8 timer
Udgravningsmængde	1,33 m <sup>3</sup>
Betonmængde	0,68 m <sup>3</sup>
Forankringsdybde	90 cm
Fragtvægt	355 kg
Forankringsmuligheder	I jorden ✓ Overflade ✓

## Garanti

Fyrretræ	10 år
Aluminum	15 år
EcoCore HDPE	Livstid
Reb & net	10 år
Garanterede reservedele	10 år

**EN**  
**1176**  
compliant



## Independent review certificate

Kompan A/S  
C. F. Tietgens Blvd. 32C, 5220 Odense SØ

Bureau Veritas hereby attests that the CO<sub>2</sub>e-calculations (covering materials, processing, waste and transport) done by Kompan for "Nature Play", meet the requirements set by the listed standard.

Kompan A/S uses a selection of EPDs and emission factors from the Life Cycle Assessment database Ecoinvent 3.11. These values are reported as kg CO<sub>2</sub>e, with all other impact categories excluded in line with the scope of ISO 14067:2018. The emission factors cover, material use, manufacturing processes, transport to Kompan, and electricity used during manufacturing. The presented emissions fall under GHG Protocol scope 3 emissions. Scope 1 and 2 are not presented. Scope 3 emissions include emission sources in the upstream value chain of a company, downstream emissions are excluded in this analysis.

Method: ISO 14067:2018 using GHG protocol guidance documents, reported as kg CO<sub>2</sub>e.

### Object

The verification has been done on the one pager "NRO40901-0601" version: 27-10-2025. The supporting documentation "KOMPAN data\_updated emissions factors\_2025\_V2" and "Emissions factors, EPD's and ecoinvent 3.11\_2025" was also reviewed and approved.

### Declaration

The verification has been completed as a critical review with a limited assurance. I hereby confirm that nothing has come to the reviewer's attention which would lead to conclude that the study does not give an accurate depiction or isn't completed following method of the CO<sub>2</sub>e calculation, the requirements of ISO 14067:2018, and 14071:2024, in the above referenced documentation.

**Note:** This verification only covers calculation elements according to method described in ISO 14067:2018 and may not be seen as a Life Cycle Assessment according to ISO 14067:2018.

**Ref.:** Kompan\_Verification report 2025, 28-10-2025

**Date of certificate:** 29-10-2025

**Expire date:** 29-10-2027

**Verified by:** Julie Marie Vejsgaard Larsen, Environmental Auditor

**Signature:**

Vugge-til-port A3	A1-	Total CO <sub>2</sub> udledning	CO <sub>2</sub> e/kg	Genanvendte materialer
		kg CO <sub>2</sub> e	kg CO <sub>2</sub> e/kg	%
KPW250501-0901		674,96	2,61	26,84

Den overordnede ramme for disse faktorer er Environmental Product Declaration (EPD), som kvantificerer "miljøoplysninger om et produkts livscyklus og muliggør sammenligninger mellem produkter, der opfylder samme funktion" (ISO, 2006). Dette følger strukturen og anvender en livscyklusvurderingstilgang til hele produktfasen fra råvarer til fremstilling (A1-A3))

# Wooden Rope Climber L

KPW250501

KOMPANI®

\* Maks. faldhøjde | \*\* Samlet højde | \*\*\* Faldområde

\* Maks. faldhøjde | \*\* Samlet højde

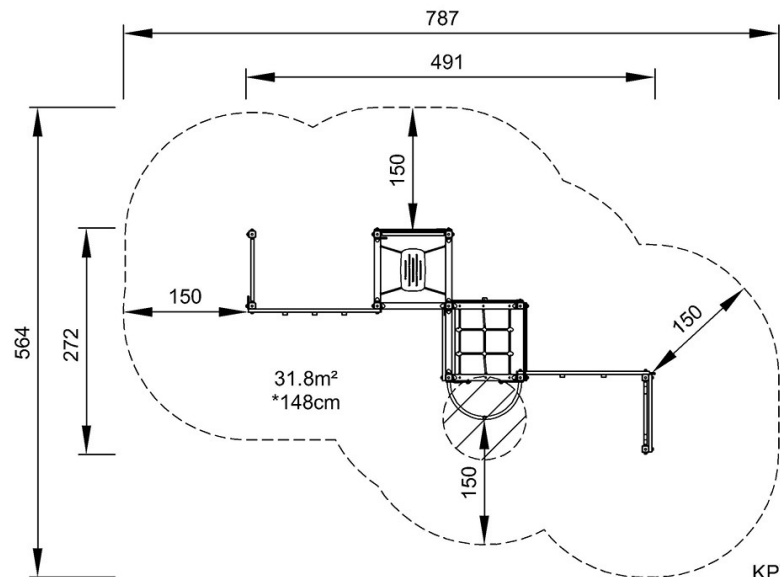

KPW250501  
\*148cm  
\*\*282cm  
\*\*\*31.8m<sup>2</sup>

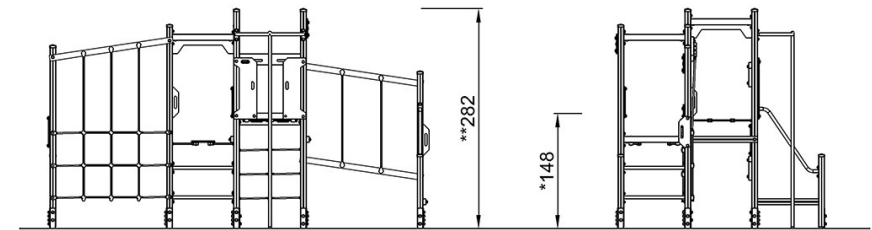

KPW250501

[Klik for at se FRA OVEN](#)

[Klik for at se FRA SIDEN](#)