

Baboon Trail

CRP250301

Item no. CRP250301-0901

General Product Information

Dimensions LxWxH	1008x421x257 cm
Age group	6+
Play capacity (users)	13
Color options	

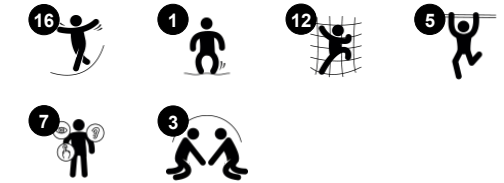
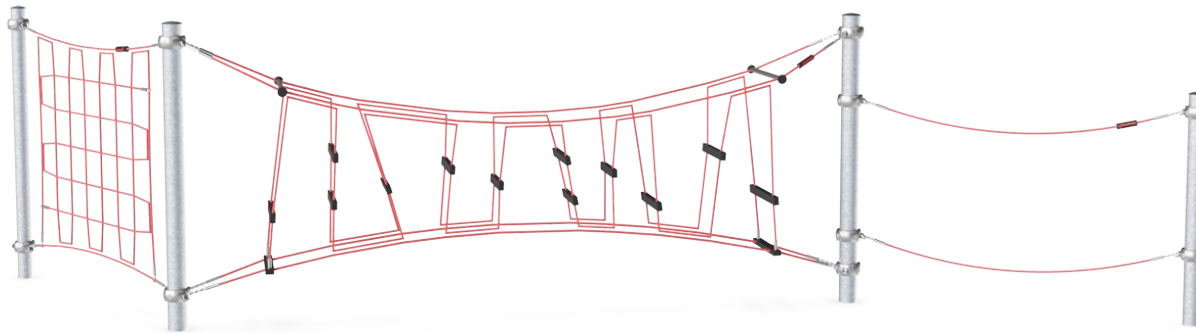

The Baboon Trail is an exciting balance and climb experience that will attract children again and again. The Tight Rope is a balance challenge, and when passing friends, children will practice turn-taking and cooperation skills. The Hurdles bounce back the child's movements, adding an element of thrill and concentration to every step. The vertical

amusement net puts the muscles to work, and legs, arms and core are trained when climbing, which also stimulates the cross-coordination and spatial awareness. These are crucial for navigating the world with physical confidence and security. The Hurdles' horizontal steps also add the opportunity to take a bouncy break and socialise. The rich variety of balancing,

swaying and climbing activities help children train their sense of balance and coordination, which are fundamental for future life skills, such as sitting still, concentrating, or navigating street traffic securely.



Baboon Trail

CRP250301

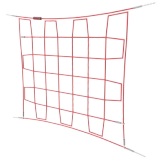

Vertical climbing net

Physical: children develop cross-body coordination when climbing. Arm, leg and core muscles are strengthened. These are important for posture control and also sitting still. **Social-Emotional:** the meshes allow for more children to sit together and talk.

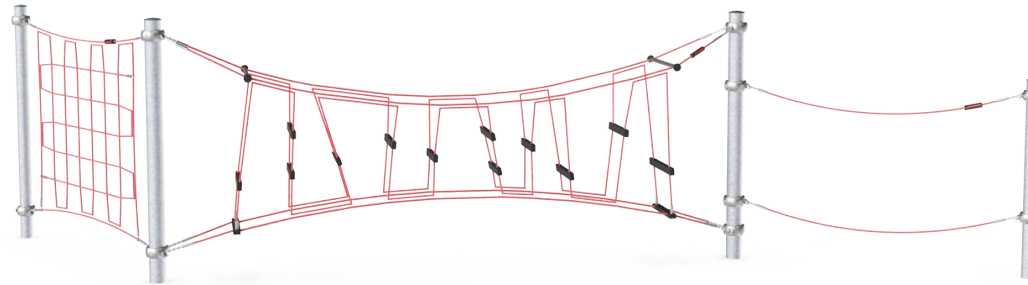

Balancing ropes

Physical: holding onto the swaying upper rope when balancing on the swaying lower rope makes excellent training of the sense of balance and trunk muscles. These abilities are fundamental for being able to sit still. **Social-Emotional:** there is room for more than one and cooperating with friends on walking over the swaying ropes is a true cooperation task that requires teamwork and tolerance.

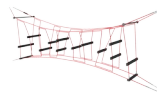

Hurdles

Physical: arm, leg and core muscles are developed when climbing up or through. Balance and spatial awareness, motor skills that help in judging the body in space. **Social-Emotional:** cooperation and turn-taking when passing one another.

Baboon Trail

CRP250301



Ropes of UV-stabilized PES rope strands with inner steel cable reinforcement. The polyester yarn is made from +95% post-consumer materials and is inductively melted onto each strand.



Corocord smart clamps are carefully designed in every detail to ensure superior flexibility in high quality aluminum material. The smart clamps are attached around the posts with four steel bolts. Not used attachment points are closed with PA caps.



Corocord 'S' clamps are used as universal connections in Corocord products. 8mm stainless steel rods with rounded edges are pressed around the ropes with a special hydraulic press, making them the ideal connector: safe, durable and vandalism-proof, all while allowing the typical movement of rope play structures.

Item no. CRP250301-0901

Installation Information

Max. fall height	240 cm
Safety surfacing area	60.3 m ²
Total installation time	11.6
Excavation volume	8.73 m ³
Concrete volume	4.85 m ³
Footing depth (standard)	90 cm
Shipment weight	587 kg
Anchoring options	Surface ✓ In-ground ✓

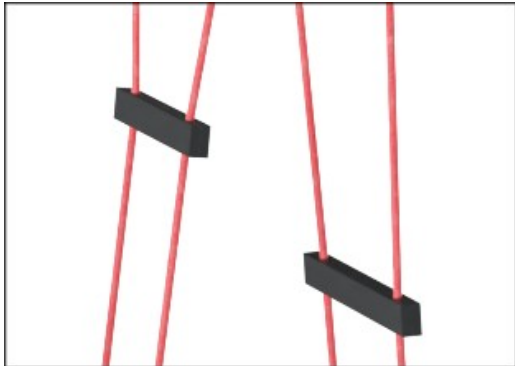

Panels of 19mm EcoCore™. EcoCore™ is a highly durable, eco friendly material, which is not only recyclable after use, but also consists of material produced from +95% recycled post consumer material from food packing waste.



Colored steel components have a base of hot dip galvanization and a powder coated top finish. This provides an ultimate corrosion resistance in all climates around the world. Other steel surfaces are hot dip galvanized inside and outside with lead free zinc.



Sustainability Data

CRP250301

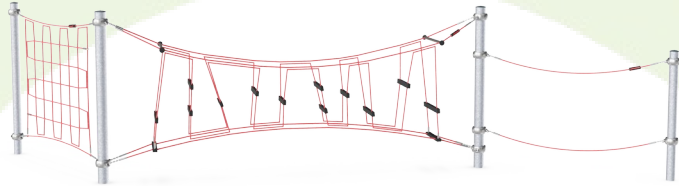

Cradle to Gate A1-A3	Total CO ₂ emission	CO ₂ e/kg	Recycled materials
	kg CO ₂ e	kg CO ₂ e/kg	%
CRP250301-0901	1,272.77	3.31	48.84

The overall framework applied for these factors is the Environmental Product Declaration (EPD), which quantifies "environmental information on the life cycle of a product and enable comparisons between products fulfilling the same function" (ISO, 2006). This follows the structure and applies a Life-Cycle Assessment approach to the entire Product stage from raw material through manufacturing (A1-A3))

Kompan A/S
 C.F. Tietgens Boulevard 32C
 DK-5220 Odense SØ
 Denmark



Verification of CO₂ calculation of: Corocord



Data version no. 2023-10-05

The CO₂ calculation and data are in compliance with the principles of a carbon footprint impact according to the GHG protocol (Greenhouse Gas Protocol), Scope 3, cradle to gate related to all individual components in the product category: "Corocord" represented by item no.: COR314011-1101.

(Scope 3 emissions include emission sources in the upstream and downstream value chain).

Date: 30. October 2023 | Valid until: 30. October 2025

Verified by:

Julie Marie Vejsgaard Larsen, LCA & EPD Consultant

Verification based on report: Validation of CO₂ calculation of 9 categories of Kompan product line, version 1.0, prepared by: Bureau Veritas HSE, Denmark: Julie M. V. Larsen.

Publication date: 30. October 2023

By Bureau Veritas HSE
 www.bureauveritas.dk
 +45 7731 1000



Baboon Trail

CRP250301

* Max fall height | ** Total height | *** Safety surfacing area

* Max fall height | ** Total height

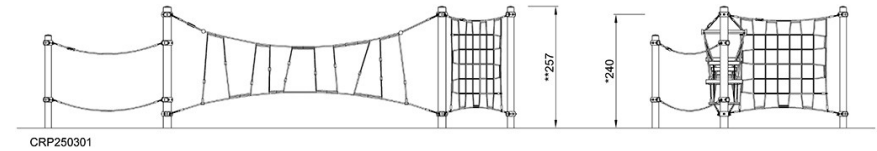
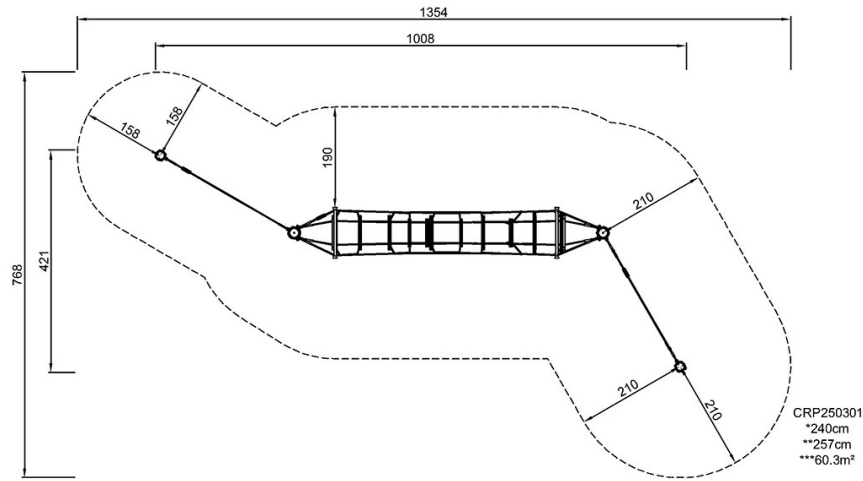

[Click to see TOP VIEW](#)

[Click to see SIDE VIEW](#)