



Rope Nest Seat 120cm H:2,5m

SW990111

Item no. SW990111-03

General Product Information

Dimensions LxWxH	193x124x0 cm
Age group	2+
Play capacity (users)	7
Colour options	  

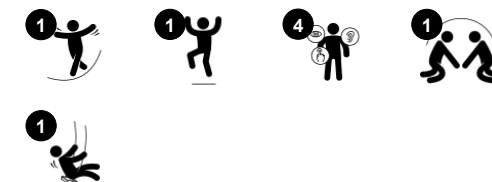

Well designed swing seats are essential to a beneficial play experience. The ropeseat focus' on user-friendliness, component quality and impact safety. Nest seats are available with a rope seat or a moulded shell seat. The seat comes with 2.5m stainless steel chains. Please note: the nest seats requires the space of two standard seats and can only be used on 2.5m

+ frames.



Rope Nest Seat 120cm H:2,5m

SW990111



Bird nest swing

Physical: develops balance, coordination and spatial awareness. The swinging movement trains the arm, leg and core muscles, and strengthens bone density when jumping off.

Social-Emotional: the spacious seat allows for many children standing, lying, seated together and is inclusive for all. **Cognitive:** cause and effect understanding, rhythm and thinking skills are developed in younger children.



Rope Nest Seat 120cm H:2,5m

SW990111

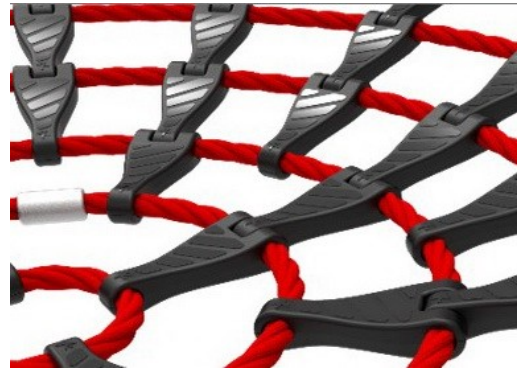

KOMPAN designed the bird's nest seats to be light in weight and in compliance with global safety standards. The soft, shock absorbent bumpers with non-slip surface makes the swing seat extremely user friendly. Choose between a rope version with reinforced PA rope or a moulded PE version. Both equipped with soft rubber bumpers.

Rope loops of the seat are made of single braided 16 mm PES ropes. The polyester yarn is made from +95% post-consumer materials and is inductively melted onto each strand. PES has high strength with excellent resistance to abrasion and UV radiation. The rope loops are connected by nylon (PA6) connectors.

The bumpers are made with a core of strong polypropylene (PP) with a softer outer layer of thermoplastic rubber (TPE). The soft, shock absorbent bumpers with non slip surface makes the swing seat extremely user friendly.

Item no. SW990111-03	
Installation Information	
Max. fall height	143 cm
Safety surfacing area	18.9 m ²
Total installation time	0.5
Excavation volume	0.00 m ³
Concrete volume	0.00 m ³
Footing depth (standard)	0 cm
Shipment weight	40 kg
Anchoring options	
Warranty Information	
Chains	10 years
PE/PP components	5 years
Ropes & nets	10 years
Spare parts guaranteed	10 years



KOMPAN heavy duty designed swing hangers of stainless steel with anti-twist function. The hangers are attached to the cross beam on a welded bracket with two bolts, The bearings are embedded with silicone lubricant and needs no further lubrication.

Upper chain and safety chain are made of high quality stainless steel to ensure durability of the product.

Ropes are made of UV-stabilised PA with inner steel cable reinforcement. The rope is induction treated in order to create a strong connection between steel and rope which leads to good wear resistance.



Sustainability Data

SW990111



Cradle to Gate A1-A3

Total CO₂ emission

CO₂e/kg

Recycled materials

kg CO₂e

kg CO₂e/kg

%

SW990111-03

189.62

5.26

24.32

The overall framework applied for these factors is the Environmental Product Declaration (EPD), which quantifies "environmental information on the life cycle of a product and enable comparisons between products fulfilling the same function" (ISO, 2006). This follows the structure and applies a Life-Cycle Assessment approach to the entire Product stage from raw material through manufacturing (A1-A3))

Kompan A/S

C.F. Tietgens Boulevard 32C
DK-5220 Odense SØ
Denmark



Verification of CO₂ calculation of: Freestanding play equipment



Data version no. 2023-10-05

The CO₂ calculation and data are in compliance with the principles of a carbon footprint impact according to the GHG protocol (Greenhouse Gas Protocol), Scope 3, cradle to gate related to all individual components in the product category: "Freestanding play equipment" represented by item no.: KSW92011-0910.

(Scope 3 emissions include emission sources in the upstream and downstream value chain).

Date: 30. October 2023 | Valid until: 30. October 2025

Verified by:

Julie Marie Vejsgaard Larsen, LCA & EPD Consultant

Verification based on report: Validation of CO₂ calculation of 9 categories of Kompan product line, version 1.0, prepared by: Bureau Veritas HSE, Denmark: Julie M. V. Larsen.

Publication date: 30. October 2023

By Bureau Veritas HSE

www.bureauveritas.dk

+45 7731 1000



Rope Nest Seat 120cm H:2,5m

SW990111

* Max fall height | ** Total height | *** Safety surfacing area

* Max fall height | ** Total height

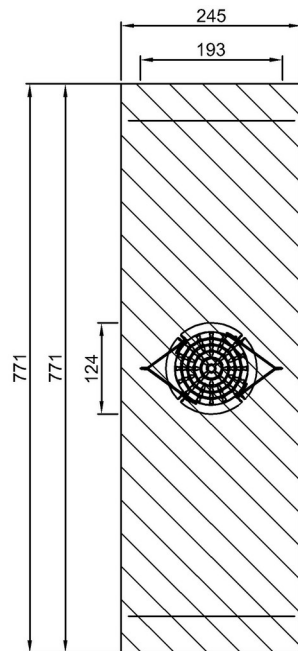

SW990111
***18.9m²

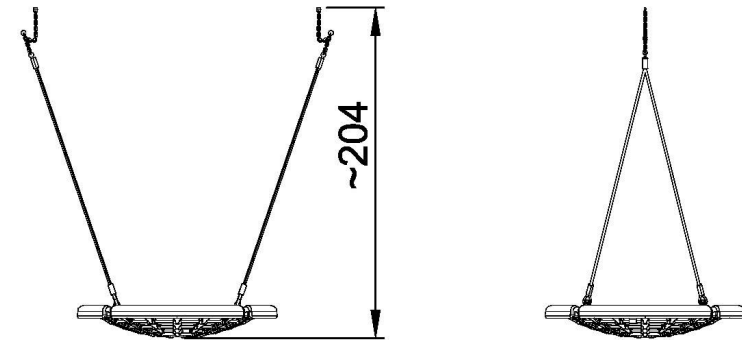

SW990111
1:100

[Click to see TOP VIEW](#)

[Click to see SIDE VIEW](#)