

Multiseesaw Foot and Backrest

M147

KOMPAN
Let's play

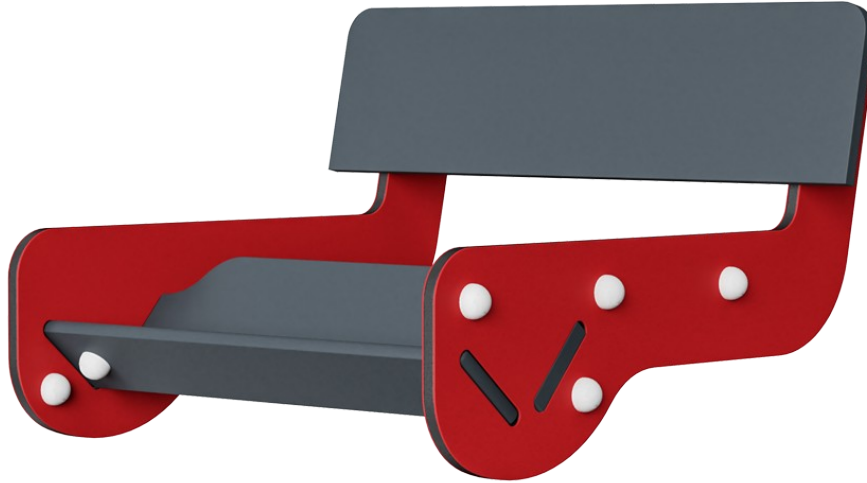

产品编号 M14701-00P

产品信息概览

长宽高尺寸	88x80x54 cm
适用年龄段	3+
容纳人数	-
颜色选择	



适用于 KOMPAN Double Seesaws 的 Multiseesaw Foot and Backrest 是一种巧妙的通用设计，可替换跷跷板任一端的座椅，并且包容所有儿童。脚部和小腿处的支撑是结实牢固的脚踏板，对于有运动障碍的儿童也很适用。此外，背部支撑也能很好地保持儿童的坐姿，符合人体工程学原理。两侧开放的设计便于儿童进入座椅，也便于照看者或父母加入到游戏中来。它的尺寸

让 4 岁及以上的腿部行动不便的儿童可以将脚放在脚踏板上，将书包伸入背部支撑，从而启动跷跷板。这让不习惯独立控制游乐设备的儿童非常满意。此外，它还能训练所有儿童在游戏中的控制感。



Multiseesaw Foot and Backrest

M147



Seat, extra foot and back support

身体素质 : extra back and foot support for children with walking disabilities. Rocking promotes sense of balance and space, both important in navigating the body in space.

Arms and leg muscles strengthened when holding tight and pushing with legs. **社交情感** : socializing and cooperation, support for all abilities.



Multiseesaw Foot and Backrest

M147

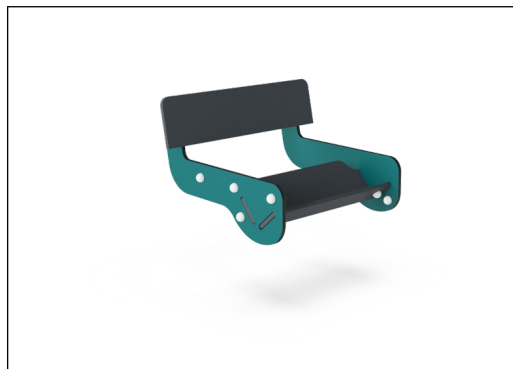

19 毫米 EcoCore™ 面板。EcoCore™ 是一种高度耐用、环保的材料，不仅在使用后可回收利用，而且还包含由 100 % 食品包装可循环材料制成的芯。

KOMPAN 环保系列产品采用终极环保材料设计，具有将二氧化碳排放当量系数降至最低的可能性。如 100% 消费后的海洋可循环材料制成的 EcoCore™ 面板。

KOMPAN
Let's play

产品编号 M14701-00P

安装信息

最大跌落高度	0 cm
安全面积	0.0 m ²
安装总时长	2.1
开挖量	0.00 m ³
混凝土使用量	0.00 m ³
标准入地深度	0 cm
运输重量	23 kg
固定选项	

质保信息

EcoCore HDPE	终身质保
承保零部件	10 年



Sustainability Data

M147

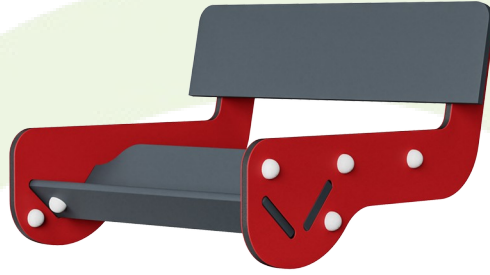

从原材料到成品

CO₂ 排放总量

kg CO₂e

CO₂ 排放量 / 千克

kg CO₂e/kg

回收的原料

%

M14701-00P

49.14

2.14

28.92

这些因素采用的总体框架为环保产品声明 (EPD), 该声明可量化“产品生命周期的环保信息, 并对相同功能的产品进行对比” (ISO, 2006)。在遵循该框架的同时, 对从原材料到制造的整个产品阶段 (A1-A3) 应用生命周期评估法。

Kompan A/S

C.F. Tietgens Boulevard 32C
DK-5220 Odense SØ
Denmark



Verification of CO₂ calculation of: Freestanding play equipment

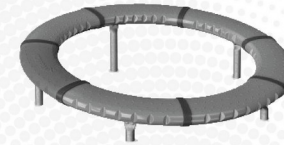

Data version no. 2023-10-05

The CO₂ calculation and data are in compliance with the principles of a carbon footprint impact according to the GHG protocol (Greenhouse Gas Protocol), Scope 3, cradle to gate related to all individual components in the product category: "Freestanding play equipment" represented by item no.: GXY916012-3417.

(Scope 3 emissions include emission sources in the upstream and downstream value chain).

Date: 30. October 2023 | Valid until: 30. October 2025

Verified by:

Julie Marie Vejsgaard Larsen, LCA & EPD Consultant

Verification based on report: Validation of CO₂ calculation of 9 categories of Kompan product line, version 1.0, prepared by: Bureau Veritas HSE, Denmark: Julie M. V. Larsen.

Publication date: 30. October 2023

By Bureau Veritas HSE
www.bureauveritas.dk
+45 7731 1000



Multiseesaw Foot and Backrest

M147

最大跌落高度 | 总高度 | 安全区域

最大跌落高度 | 总高度

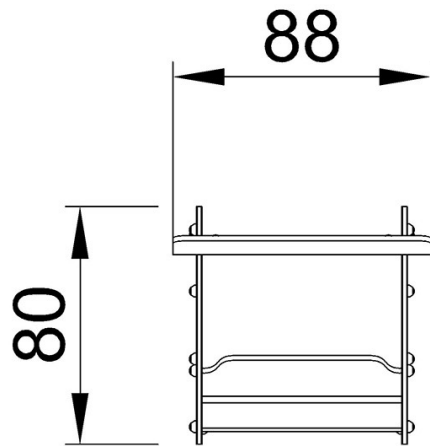

M14700

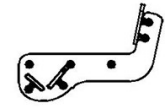
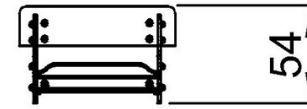

M14700

[点击查看俯视图](#)

[点击查看侧面图](#)