

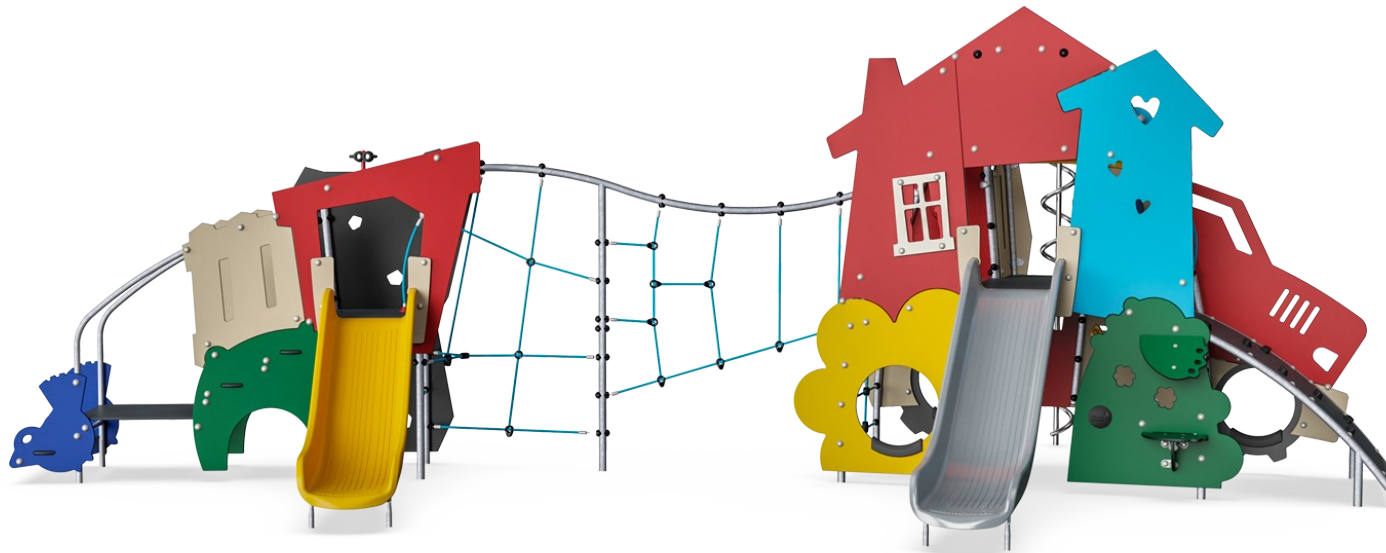

Home & Rescue with Net Tower

MSC6411



Item no. MSC641100-3717P	
General Product Information	
Dimensions LxWxH	27'0"x15'6"x9'4"
Age group	2 - 5
Play capacity (users)	30
Color options	

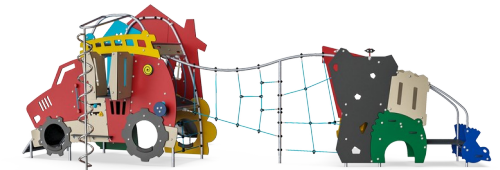
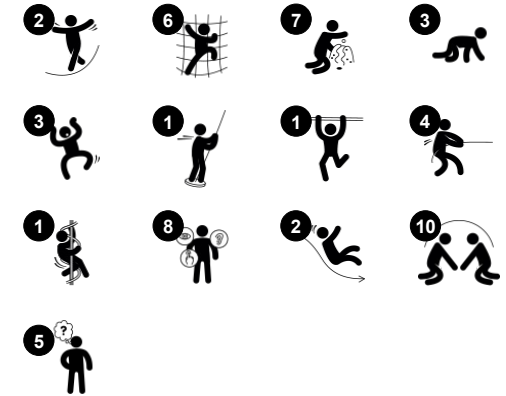

WOW! The roomy Home & Rescue themes hugely appeal to children's dramatic play stories. The ground level den invites a break with friends. There is a Home side and a Rescue side, inspiring vigorous play stories. Thanks to the two-sided themed panels and the varied climbers: curved, round, straight and net climbers, there are challenges for a wide

user group. The climbing events, slides and glides train motor skills, such as cross-coordination and balance, important for navigating the world confidently. The meeting points are many, as the Home & Rescue can be played from all sides. The huge net adds volume and active meeting. From the upper level, children can look communicate through

the window with ground level. So the social play invitation is immense. Children meet, greet and play, making friends for life.

Home & Rescue with Net Tower

MSC6411



Binoculars

Cognitive: the binoculars set a tangible theme and so spur dramatic play. Dramatic play is great for developing language and communication skills. **Creative:** the binoculars can be turned in all directions. Looking through them gives a new perspective on the world.

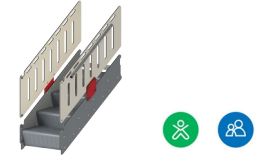

Accessible stairway

Physical: climbing the accessible stairway is for all and supports cross coordination as well as arm and leg muscles. For young children, walking stairs and alternating feet is developed. **Social-Emotional:** room for active breaks and adult helpers. An inclusive space.



Climbing net

Physical: children develop cross-body coordination and muscle strength. The asymmetry of the net challenges the children's climbing.



Curly climber

Physical: coordination and proprioception are supported when placing arms and legs correctly for going down. Sense of balance when rotating. Arm muscles for holding tight. **Social-Emotional:** empathy stimulated by turn-taking. **Cognitive:** logical thinking when placing arms and legs right for rotating downward.



Den

Physical: crawling through the possible openings trains spatial awareness. **Social-Emotional:** the enclosed space invites social play for two or three children.



Crawl-through hole

Physical: the hole allows for climbing and crawling through, developing cross coordination, proprioception and spatial awareness. **Social-Emotional:** cooperation and turn-taking when passing one another. **Cognitive:** understanding space, shape and measurements when seeing if the body can fit through the hole.



Slide

Physical: sliding develops spatial awareness and a sense of balance. Furthermore, the core muscles are trained when sitting upright going down. **Social-Emotional:** empathy stimulated by turn-taking. **Cognitive:** young children develop their understanding of space, speed and distances when sliding down quickly.

Home & Rescue with Net Tower

MSC6411

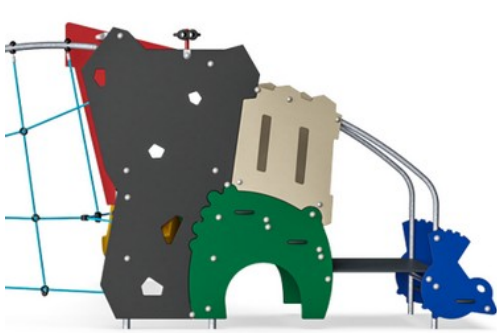

Panels of 19mm EcoCore™. EcoCore™ is a highly durable, eco friendly material, which is not only recyclable after use, but also consists of a core produced from 100% recycled material.

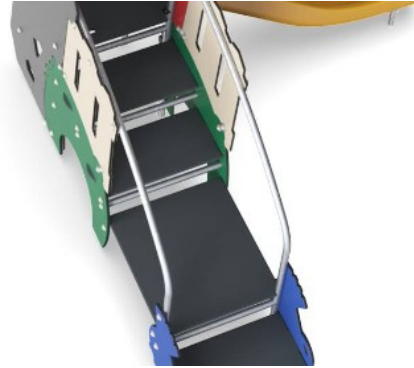

All floors are made of High-Pressure Laminate HPL with a thickness 17.8mm and non skid surface texture according to EN 438-6. KOMPAN HPL has high wearing strength to ensure long lifetime in all climates.

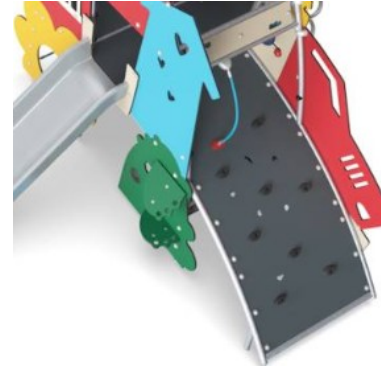

Curved climbing wall is made of Ekogrip® panel that consist of a 15mm thick PE base with 3 mm top-layer of soft rubber with a non-skid effect.



The slide is made of molded PE. PE has high impact resistance across a wide temperature span which ensures vandal resistance in all locations.

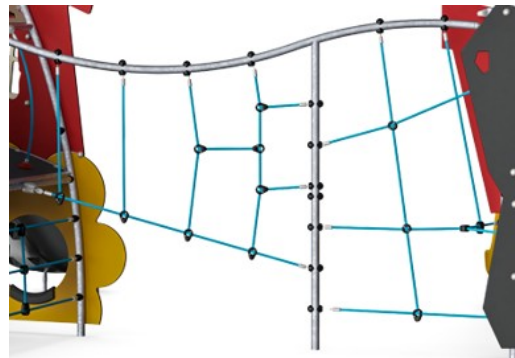

Ropes are made of UV-stabilized PP rope strands with inner steel cable reinforcement. Horizontal ropes are PUR coated to obtain good wear and tear resistance.

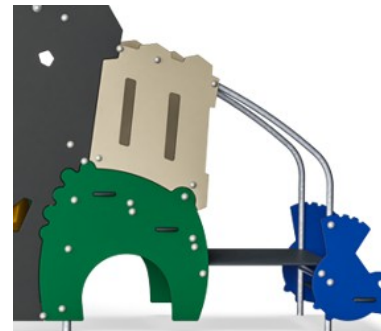

The steel surfaces are hot-dip galvanized inside and outside with lead-free zinc. The galvanization has excellent corrosion resistance in outside environments and requires minimal maintenance.

Item no. MSC641100-3717P

Installation Information

Max. fall height	7'5"
Safety surfacing area	725ft²
Total installation time	32.7
Excavation volume	2.01yd³
Concrete volume	0yd³
Footing depth (standard)	2'11"
Shipment weight	2103lbs
Anchoring options	In-ground ✓ Surface ✓

Warranty Information

EcoCore HDPE	Lifetime
Hot dip galvanized steel	Lifetime
HPL decks	15 Years
Ropes & nets	10 Years
Spare Parts Availability	10 Years

Elevated activities 10	Accessible elevated activities	Accessible ground level activities	Accessible ground level play types
Present	10	8	4
Required	5	3	3

ASTM F1487
compliant

Sustainability Data

MSC6411

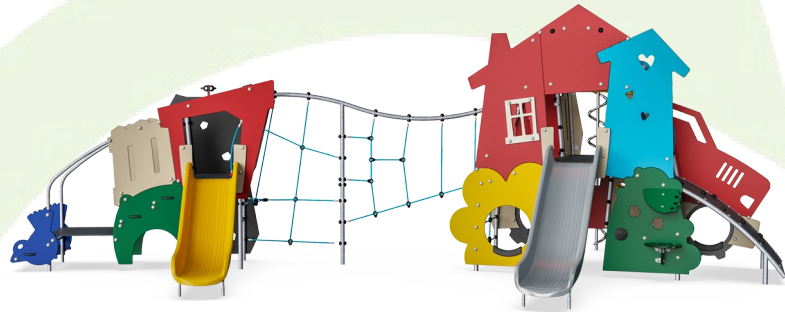

Cradle to Gate A1-A3	Total CO ₂ emission	CO ₂ e/kg	Recycled materials
	kg CO ₂ e	kg CO ₂ e/kg	%
MSC641100-3717P	1,922.24	2.26	53.78

The overall framework applied for these factors is the Environmental Product Declaration (EPD), which quantifies "environmental information on the life cycle of a product and enable comparisons between products fulfilling the same function" (ISO, 2006). This follows the structure and applies a Life-Cycle Assessment approach to the entire Product stage from raw material through manufacturing (A1-A3))

Kompan A/S
C.F. Tietgens Boulevard 32C
DK-5220 Odense SØ
Denmark



Verification of CO₂ calculation of: Themed play systems



Data version no. 2023-10-05

The CO₂ calculation and data are in compliance with the principles of a carbon footprint impact according to the GHG protocol (Greenhouse Gas Protocol), Scope 3, cradle to gate related to all individual components in the product category: "Themed play systems" represented by item no.: MSC641100-3717P.

(Scope 3 emissions include emission sources in the upstream and downstream value chain).

Date: 30. October 2023 | Valid until: 30. October 2025

Verified by:

Julie Marie Vejsgaard Larsen, LCA & EPD Consultant

Verification based on report: Validation of CO₂ calculation of 9 categories of Kompan product line, version 1.0, prepared by: Bureau Veritas HSE, Denmark: Julie M. V. Larsen.

Publication date: 30. October 2023

By Bureau Veritas HSE
www.bureauveritas.dk
+45 7731 1000



Home & Rescue with Net Tower

MSC6411

* Max fall height | ** Total height | *** Safety surfacing area

* Max fall height | ** Total height

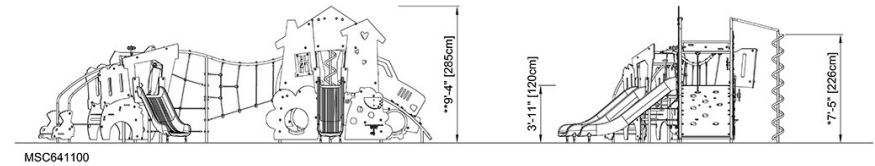
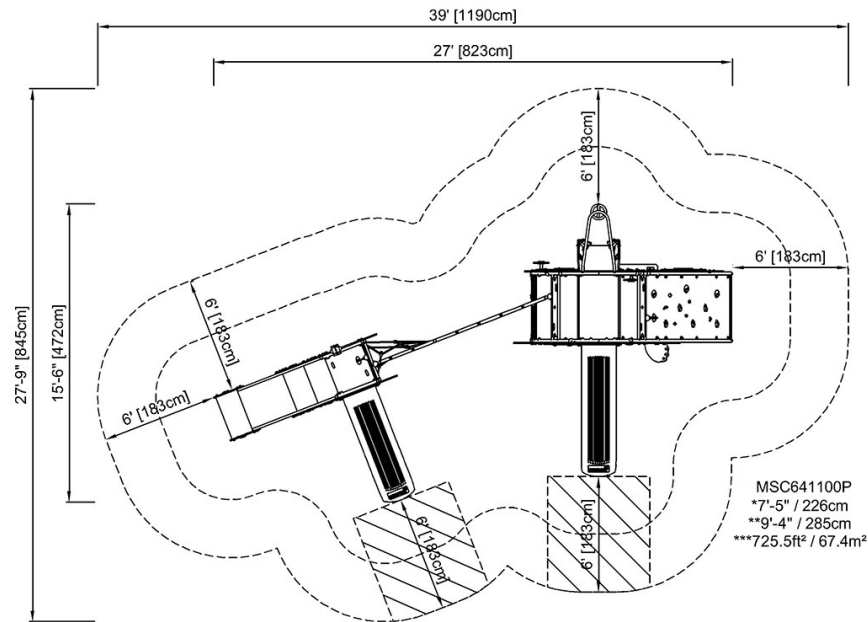

[Click to see TOP VIEW](#)

[Click to see SIDE VIEW](#)