

# Magnetic White Board

PCM0013

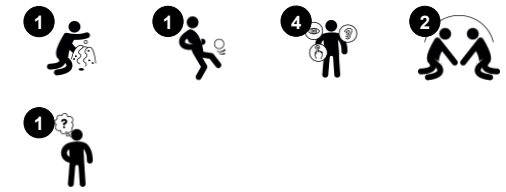

Item no. PCM001308-0902	
<b>General Product Information</b>	
Dimensions LxWxH	166x12x140 cm
Age group	2+
Play capacity (users)	4
Color options	



This large magnetic white board will support hours of play and learning in an outdoor learning environment or playground. The large space is plenty for many children to join in, which will help them to develop fine motor skills when drawing, and language and literacy skills when making signs. The large size supports social play, because there is plenty of room for

interaction and cooperation. White boards can have direct benefits for learning, and they also enhance a variety of dramatic play scenarios, from playing school to making a sign for treasure hunting games. There are cognitive benefits to drawing and leaving your mark, because it stimulates brain development. The magnetic feature can also spark conversations

about the magnetic properties of objects. All around fun for curious minds!



# Magnetic White Board

PCM0013

Board is made of ceramic steel. Ceramic steel has high corrosion resistance and it is completely recyclable.

Posts are made of pine wood from sustainable European sources. The wood is pressure impregnated Class 3 with Tanalith E3475 according to EN335 (Equivalent to NTR Class AB).

Panels of 19mm EcoCore™. EcoCore™ is a highly durable, eco friendly material, which is not only recyclable after use, but also consists of material produced from +95% recycled post consumer material from food packing waste.

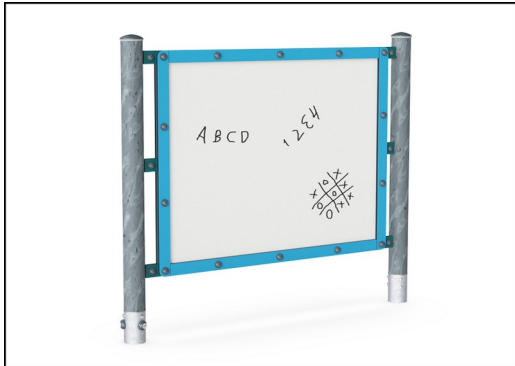

KOMPAN GreenLine versions are designed with ultimate environmentally friendly materials with lowest possible CO2e emission factor such as EcoCore™ panels of +95% post consumer recycled ocean waste.

Item no. PCM001308-0902	
Installation Information	
Max. fall height	0 cm
Safety surfacing area	12.3 m <sup>2</sup>
Total installation time	3.8
Excavation volume	0.05 m <sup>3</sup>
Concrete volume	0.00 m <sup>3</sup>
Footing depth (standard)	85 cm
Shipment weight	86 kg
Anchoring options	In-ground ✓ Surface ✓



# Sustainability Data

PCM0013



<b>Cradle to Gate A1-A3</b>	<b>Total CO<sub>2</sub> emission</b>	<b>CO<sub>2</sub>e/kg</b>	<b>Recycled materials</b>
	kg CO <sub>2</sub> e	kg CO <sub>2</sub> e/kg	%
<b>PCM001308-0950</b>	101.40	1.47	80.40
<b>PCM001308-0902</b>	126.40	2.07	70.00

The overall framework applied for these factors is the Environmental Product Declaration (EPD), which quantifies "environmental information on the life cycle of a product and enable comparisons between products fulfilling the same function" (ISO, 2006). This follows the structure and applies a Life-Cycle Assessment approach to the entire Product stage from raw material through manufacturing (A1-A3))

# Magnetic White Board

PCM0013

\* Max fall height | \*\* Total height | \*\*\* Safety surfacing area

\* Max fall height | \*\* Total height

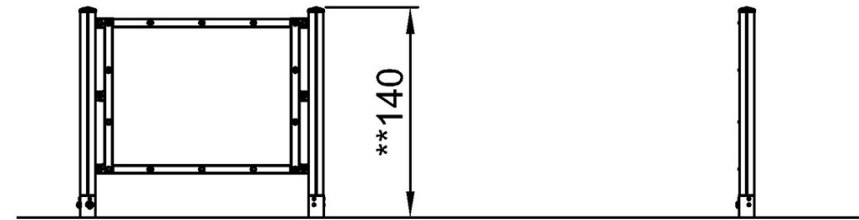
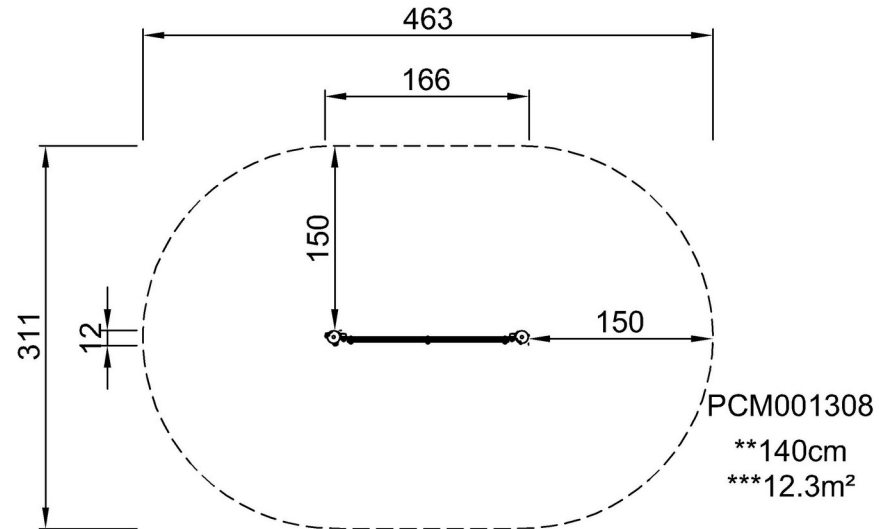

PCM001308  
1:100

[Click to see TOP VIEW](#)

[Click to see SIDE VIEW](#)