



Play Tower with Banister Bars

KPL1019



Item no. KPL101911-0902	
General Product Information	
Dimensions LxWxH	395x587x376 cm
Age group	4+
Play capacity (users)	12
Color options	 

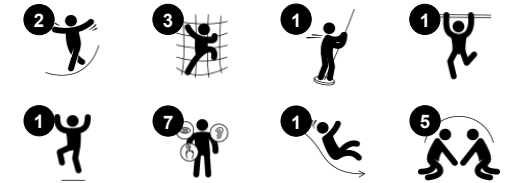

The Play Tower with Banister Bars sustains play with opportunities for children to move their bodies by climbing, stretching, and sliding. Under the structure, a play panel adds an opportunity for quieter play. The structure motivates children by providing variety and graduated challenges in climbing and navigating the tower and net. Climbing

strengthens muscles and helps to develop cross-coordination skills. This enhances a child's ability to use both sides of their brain, and supports brain structures that enable reading and thinking. On the platform a view of the playground from above adds a feeling of breathtaking height. Sliding is immensely thrilling. It also supports posture and balance,

important skills for young children as they grow. They are the basis for all other physical skills and help to build up confidence to navigate the world securely. With the varied activities in the structure, children will play here again and again.

Play Tower with Banister Bars

KPL1019



Panels of 19mm EcoCore™. EcoCore™ is a highly durable, eco friendly material, which is not only recyclable after use, but also consists of material produced from +95% recycled post consumer material from food packing waste.

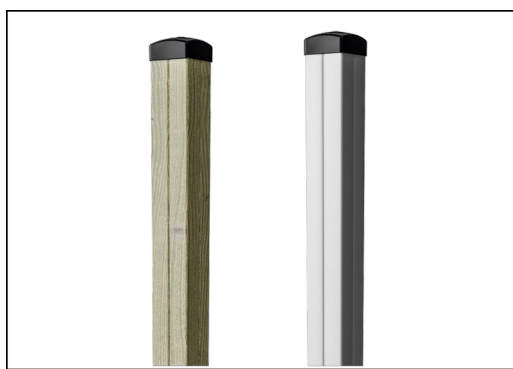

The main tower posts of either pine wood or aluminium are all equipped with hot dip galvanised steel footings. The steel footings elevates the posts 20mm from ground level to avoid contact with surfacing material.

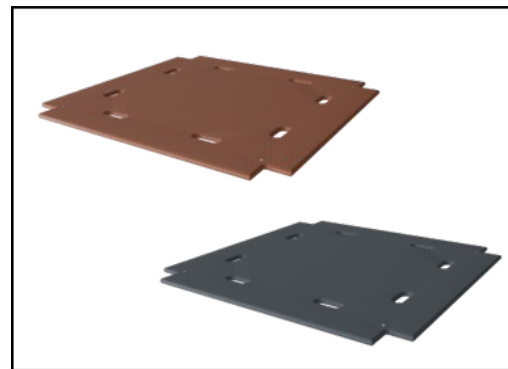

Floors and panel activities are available in two types of material: Waterproof plywood decks thickness 21.5mm from pine and alder wood with anti-slip film on both sides. High Pressure Laminate HPL thickness 17.8mm with slip resistant surface texture according to EN 438-6.

Item no. KPL101911-0902

Installation Information

Max. fall height	209 cm
Safety surfacing area	41.0 m ²
Total installation time	12.7
Excavation volume	1.35 m ³
Concrete volume	0.50 m ³
Footing depth (standard)	90 cm
Shipment weight	404 kg
Anchoring options	In-ground ✓ Surface ✓

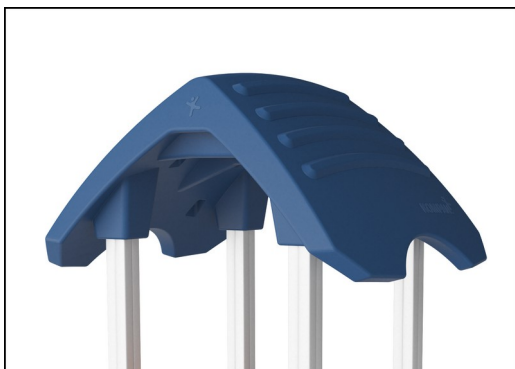

The large hollow components are made of 100% recyclable PE. The roof displayed is moulded in one piece with minimum 5,5mm wall thickness to ensure high durability in all climates around the world.

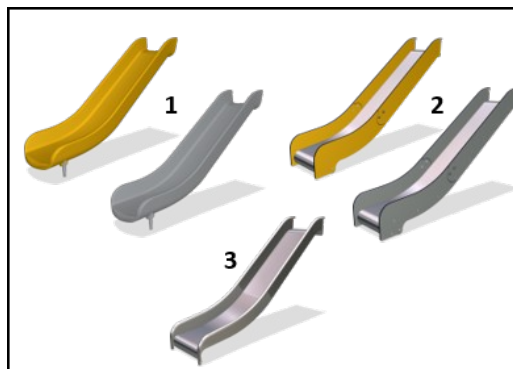

Slides are available in three different materials: moulded on piece PE slides, Combined EcoCore™ sides and stainless steel slide bed t=2mm. Full stainless steel AISI304 t=2mm.



Climbing nets are made of UV-stabilised PP rope with inner steel cable reinforcement. The rope is induction treated to obtain maximum fixation between steel and rope which provides excellent wear and tear resistance. All rope connectors are made of 100% recyclable PA material.



Sustainability Data

KPL1019



Cradle to Gate A1-A3	Total CO ₂ emission	CO ₂ e/kg	Recycled materials
	kg CO ₂ e	kg CO ₂ e/kg	%
KPL101911-0902	481.30	1.53	34.40

The overall framework applied for these factors is the Environmental Product Declaration (EPD), which quantifies "environmental information on the life cycle of a product and enable comparisons between products fulfilling the same function" (ISO, 2006). This follows the structure and applies a Life-Cycle Assessment approach to the entire Product stage from raw material through manufacturing (A1-A3))

Kompan A/S
C.F. Tietgens Boulevard 32C
DK-5220 Odense SØ
Denmark



Verification of CO₂ calculation of: Play systems



Data version no. 2023-10-05

The CO₂ calculation and data are in compliance with the principles of a carbon footprint impact according to the GHG protocol (Greenhouse Gas Protocol), Scope 3, cradle to gate related to all individual components in the product category: "Play systems" represented by item no.: PCM200321-0950.

(Scope 3 emissions include emission sources in the upstream and downstream value chain).

Date: 30. October 2023 | Valid until: 30. October 2025

Verified by:

Julie Marie Vejsgaard Larsen, LCA & EPD Consultant

Verification based on report: Validation of CO₂ calculation of 9 categories of Kompan product line, version 1.0, prepared by: Bureau Veritas HSE, Denmark: Julie M. V. Larsen.

Publication date: 30. October 2023

By Bureau Veritas HSE
www.bureauveritas.dk
+45 7731 1000



Play Tower with Banister Bars

KPL1019

* Max fall height | ** Total height | *** Safety surfacing area

* Max fall height | ** Total height

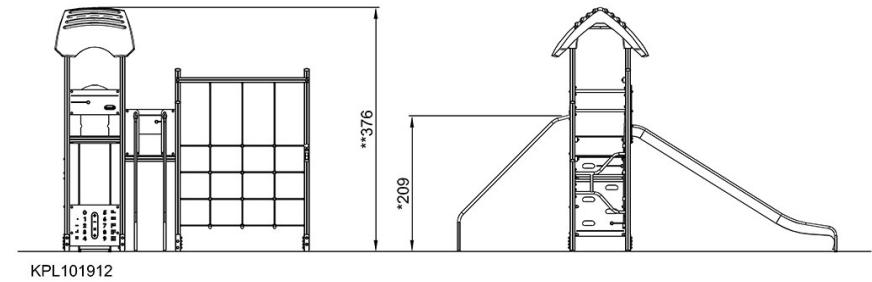
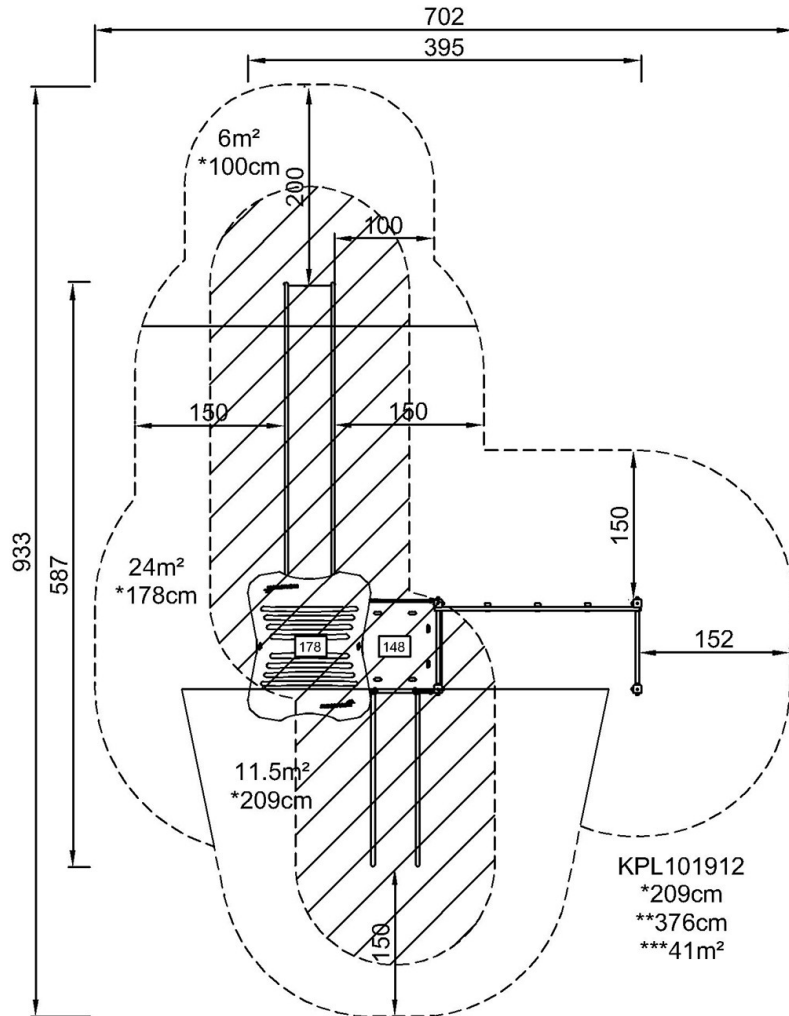

[Click to see TOP VIEW](#)

[Click to see SIDE VIEW](#)