

Two Towers with Bridge

PCM200521

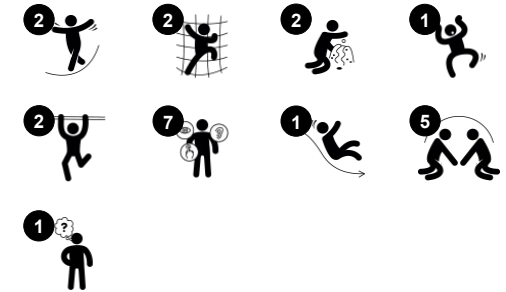

Item no. PCM200521-0603	
General Product Information	
Dimensions LxWxH	329x255x211 cm
Age group	1+
Play capacity (users)	11
Colour options	



The Two Towers with Bridge-structure holds amazing play attractions for toddlers. The variety of physical play events will make them come back for more play, again and again and stay playing for a long time. The step stairway is spacious enough for two children to pass each other. This makes sense as looping the bridge, slide and stairways is a favourite

activity on the Two Towers with Bridge. Walking or crawling up the stairs trains cross-coordination, important for cross-modal perception and reading skills. The bridge is an amazing, moving balance trainer that stimulates all the vestibular system of the child, fundamental for all other motor skills and the ability to manage the world safely. The slide

gives a stomach tickling trip to the ground, stimulating the core stability and the sense of balance of the child.



Two Towers with Bridge

PCM200521



Window

Social-Emotional: invites interaction between sides and cooperative play.



Balcony

Social-Emotional: the balcony invites meetings and interaction with people on ground level. **Cognitive:** invites dramatic play and performance, which stimulates language development.



Slide

Physical: sliding develops spatial awareness and a sense of balance. Furthermore, the core muscles are trained when sitting upright going down. **Social-Emotional:** empathy stimulated by turn-taking. **Cognitive:** young children develop their understanding of space, speed and distances when sliding down quickly.



Trekking bridge

Physical: the wobbly bridge trains balance and coordination as well as spatial awareness: when children cross the bridge by running or jumping. **Social-Emotional:** turn-taking and consideration when passing each other. Cooperation and socializing with others in and around the bridge.



Flower panel

Social-Emotional: invites cooperation due to the two-sidedness and provides for parallel play. **Cognitive:** suggests a theme and supports dramatic play, which stimulates language and communication skills.

Two Towers with Bridge

PCM200521



Panels of 19mm EcoCore™. EcoCore™ is a highly durable, eco friendly material, which is not only recyclable after use, but is also produced from +95% recycled post consumer material from food packing waste. Wooden panels of impregnated and brown painted pine wood with vertical steel profiles.



Main posts with hot dip galvanized steel footing are available in different materials: Pressure impregnated pine wood posts. Pre-galvanized inside and outside with powder coated top finish steel posts. Lead free aluminum with color anodized top finish. Greenline TexMade posts of 95% post-consumer recycled PE and textile waste.

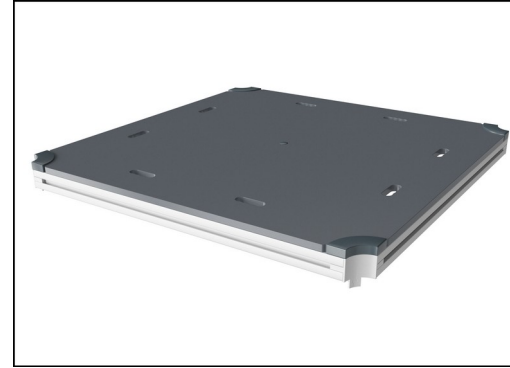

All decks are supported by unique designed low-carbon aluminum profiles with multiple attachment options. The grey colored molded decks are made of 75% post-consumer waste PP material with a non-skid pattern and texture surface.

Item no. PCM200521-0603

Installation Information

Max. fall height	100 cm
Safety surfacing area	25.4 m ²
Total installation time	12.4
Excavation volume	0.52 m ³
Concrete volume	0.00 m ³
Footing depth (standard)	60 cm
Shipment weight	392 kg
Anchoring options	In-ground ✓ Surface ✓

Warranty Information

EcoCore HDPE	Lifetime
Post	10 years
PP Decks	10 years
Spare parts guaranteed	10 years



Coloured steel components have a base of hot dip galvanisation and a powder coated top finish. This provides an ultimate corrosion resistance in all climates around the world.



The slides can be chosen in six different colors and three materials: Straight or curved one-piece molded PE slides, made from 33% recycled post-consumer materials in different colours. Combined EcoCore™ sides and stainless-steel. Full stainless steel in one piece design for more vandalism proof solutions.

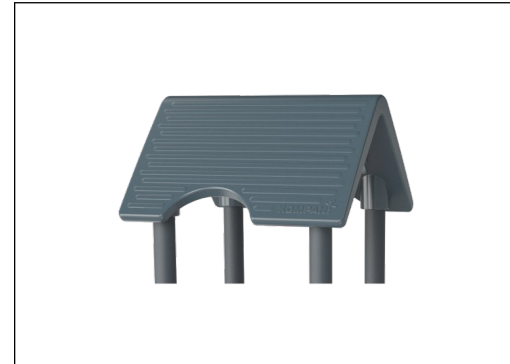

Roof is made from rotomoulded PE with 33% Post-consumer materials. PE has high impact resistance across a wide temperature span which ensures durability.



Sustainability Data

PCM200521



Cradle to Gate A1-A3	Total CO ₂ emission	CO ₂ e/kg	Recycled materials
	kg CO ₂ e	kg CO ₂ e/kg	%
PCM200521-0651	497.79	1.77	60.44
PCM200521-0603	490.93	1.78	23.55

The overall framework applied for these factors is the Environmental Product Declaration (EPD), which quantifies "environmental information on the life cycle of a product and enable comparisons between products fulfilling the same function" (ISO, 2006). This follows the structure and applies a Life-Cycle Assessment approach to the entire Product stage from raw material through manufacturing (A1-A3))

Kompan A/S
C.F. Tietgens Boulevard 32C
DK-5220 Odense SØ
Denmark



Verification of CO₂ calculation of: Play systems



Data version no. 2023-10-05

The CO₂ calculation and data are in compliance with the principles of a carbon footprint impact according to the GHG protocol (Greenhouse Gas Protocol), Scope 3, cradle to gate related to all individual components in the product category: "Play systems" represented by item no.: PCM200321-0950.

(Scope 3 emissions include emission sources in the upstream and downstream value chain).

Date: 30. October 2023 | Valid until: 30. October 2025

Verified by:

Julie Marie Vejsgaard Larsen, LCA & EPD Consultant

Verification based on report: Validation of CO₂ calculation of 9 categories of Kompan product line, version 1.0, prepared by: Bureau Veritas HSE, Denmark: Julie M. V. Larsen.

Publication date: 30. October 2023

By Bureau Veritas HSE
www.bureauveritas.dk
+45 7731 1000



Two Towers with Bridge

PCM200521

* Max fall height | ** Total height | *** Safety surfacing area

* Max fall height | ** Total height

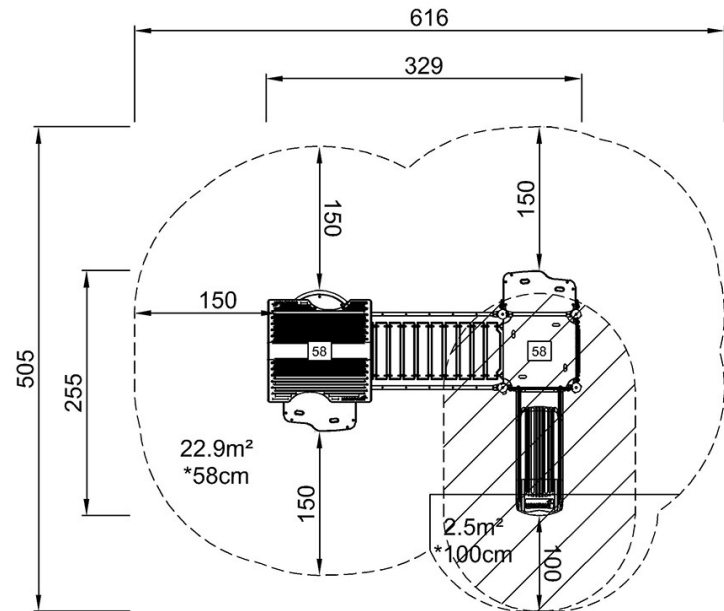

PCM200521
*100cm
**216cm
***25.4m²

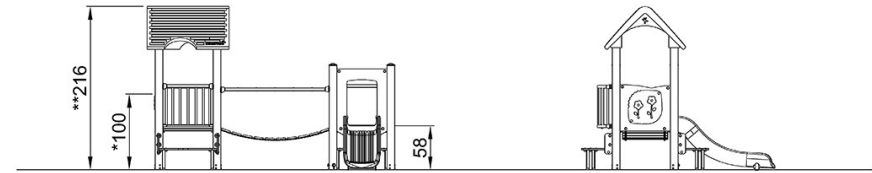

PCM200521

[Click to see TOP VIEW](#)

[Click to see SIDE VIEW](#)