

# Home & Ocean with Net & Tower

MSC6405

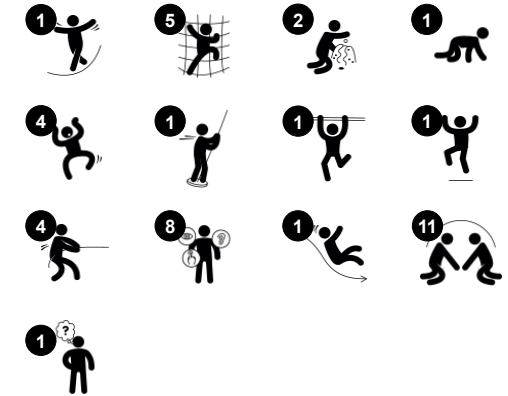

| Item no. MSC640500-3717P    |                                    |
|-----------------------------|------------------------------------|
| General Product Information |                                    |
| Dimensions LxWxH            | 731x415x285 cm                     |
| Age group                   | 2+                                 |
| Play capacity (users)       | 29                                 |
| Color options               | <span style="color: red;">●</span> |



WOW! The roomy Home & Ocean themes hugely appeal to children's dramatic play stories. The ground level den invites a break with friends. There is a Home side and an Ocean side, inspiring vigorous play stories. Thanks to the two-sided themed panels and the varied climbers: curved, round, straight and net climbers, there are challenges for a wide

user group. The climbing events, slides and glides train motor skills, such as cross-coordination and balance, important for navigating the world confidently. There are so many meeting points as the Home & Ocean can be played in from all sides. The huge net adds volume and creates active meetings. From the upper level, children can look

communicate through the window with those on the ground level so the social play possibility is immense. Children meet, greet and play, making friends for life.



# Home & Ocean with Net & Tower

MSC6405

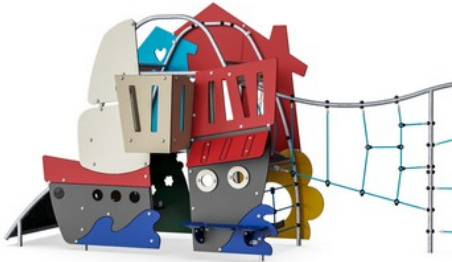

Panels of 19mm EcoCore™. EcoCore™ is a highly durable, eco friendly material, which is not only recyclable after use, but also consists of material produced from +95% recycled post consumer material from food packing waste.

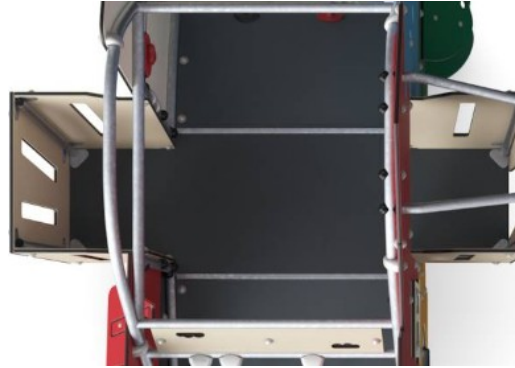

All floors are made of High-Pressure Laminate HPL with a thickness 17.8mm and non skid surface texture according to EN 438-6. KOMPAN HPL has high wearing strength to ensure long lifetime in all climates.

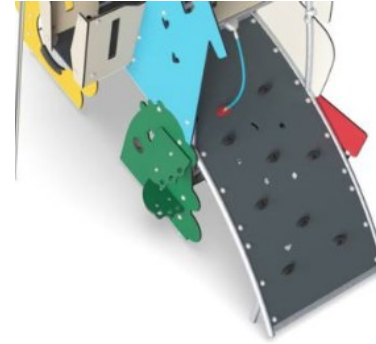

Curved climbing wall is made of Ekogrip® panel that consist of a 15mm thick PE base with 3 mm top-layer of soft rubber with a non-skid effect.

Item no. MSC640500-3717P

## Installation Information

|                          |                          |
|--------------------------|--------------------------|
| Max. fall height         | 193 cm                   |
| Safety surfacing area    | 47.2 m <sup>2</sup>      |
| Total installation time  | 30.7                     |
| Excavation volume        | 1.47 m <sup>3</sup>      |
| Concrete volume          | 0.00 m <sup>3</sup>      |
| Footing depth (standard) | 90 cm                    |
| Shipment weight          | 958 kg                   |
| Anchoring options        | In-ground ✓<br>Surface ✓ |



The slide is made of moulded PE. PE has high impact resistance across a wide temperature span which ensures vandal resistance in all locations.

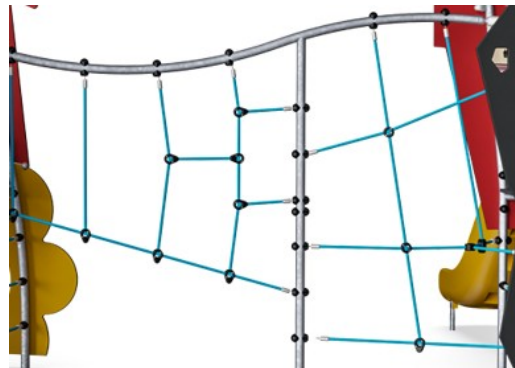

Ropes are made of UV-stabilised PA with inner steel cable reinforcement. The rope is induction treated in order to create a strong connection between steel and rope which leads to good wear resistance.



The steel surfaces are hot dip galvanised inside and outside with lead free zinc. The galvanisation has excellent corrosion resistance in outside environments and requires low maintenance.



# Sustainability Data

MSC6405



| Cradle to Gate A1-A3   | Total CO <sub>2</sub> emission | CO <sub>2</sub> e/kg    | Recycled materials |
|------------------------|--------------------------------|-------------------------|--------------------|
|                        | kg CO <sub>2</sub> e           | kg CO <sub>2</sub> e/kg | %                  |
| <b>MSC640500-3717P</b> | 1,754.70                       | 2.25                    | 54.70              |

The overall framework applied for these factors is the Environmental Product Declaration (EPD), which quantifies "environmental information on the life cycle of a product and enable comparisons between products fulfilling the same function" (ISO, 2006). This follows the structure and applies a Life-Cycle Assessment approach to the entire Product stage from raw material through manufacturing (A1-A3))

**Kompan A/S**  
 C.F. Tietgens Boulevard 32C  
 DK-5220 Odense SØ  
 Denmark



## Verification of CO<sub>2</sub> calculation of: Themed play systems

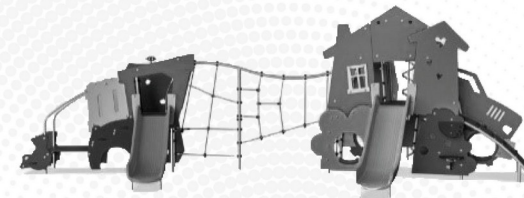

Data version no. 2023-10-05

The CO<sub>2</sub> calculation and data are in compliance with the principles of a carbon footprint impact according to the GHG protocol (Greenhouse Gas Protocol), Scope 3, cradle to gate related to all individual components in the product category: "Themed play systems" represented by item no.: MSC641100-3717P.

(Scope 3 emissions include emission sources in the upstream and downstream value chain).

**Date: 30. October 2023 | Valid until: 30. October 2025**

Verified by:

Julie Marie Vejsgaard Larsen, LCA & EPD Consultant

Verification based on report: Validation of CO<sub>2</sub> calculation of 9 categories of Kompan product line, version 1.0, prepared by: Bureau Veritas HSE, Denmark: Julie M. V. Larsen.

**Publication date: 30. October 2023**

By Bureau Veritas HSE  
 www.bureauveritas.dk  
 +45 7731 1000



# Home & Ocean with Net & Tower

MSC6405

\* Max fall height | \*\* Total height | \*\*\* Safety surfacing area

\* Max fall height | \*\* Total height

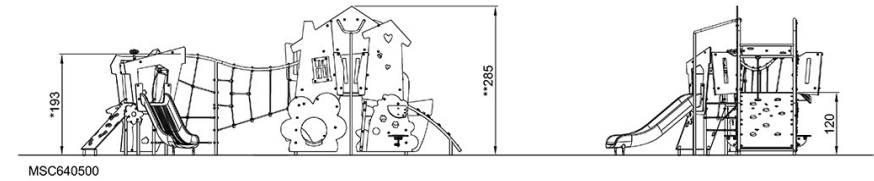
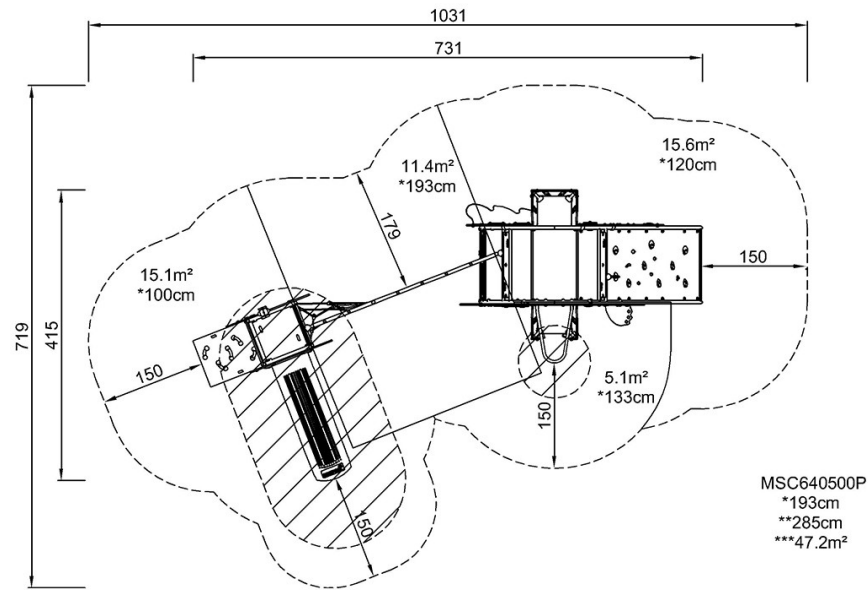

[Click to see TOP VIEW](#)

[Click to see SIDE VIEW](#)