

Hopper

ELE400022



Item no. ELE400022-01	
General Product Information	
Dimensions LxWxH	325x41x82 cm
Age group	2 - 5
Play capacity (users)	4
Colour options	



The Hopper with its round bodies and vibrant colours invite children to try out the rocking experience. Due to the many body positions and play possibilities invited through the design, children will play for a long time and come back again and again. The platform in the middle makes a nice entrance point for sitting, lying or standing while rocking the

others. Or, while being rocked by them. The rounded seats and foot and handholds allow children to give it a good go. Rocking on the Hopper is a different seesaw experience, as the springs allows for users of different weights and abilities to play and cooperate. Seesaws are great for cooperative play: the child needs to consider the rhythm of the other players'

movement to make seesawing work. This is a great trainer of cooperation and consideration. Furthermore, children with e.g. autism get a chance for social play in a secure framework.



Hopper

ELE400022



Rocking together

Social-Emotional: the possibility of rocking two together trains cooperation skills. Consideration of others when rocking.

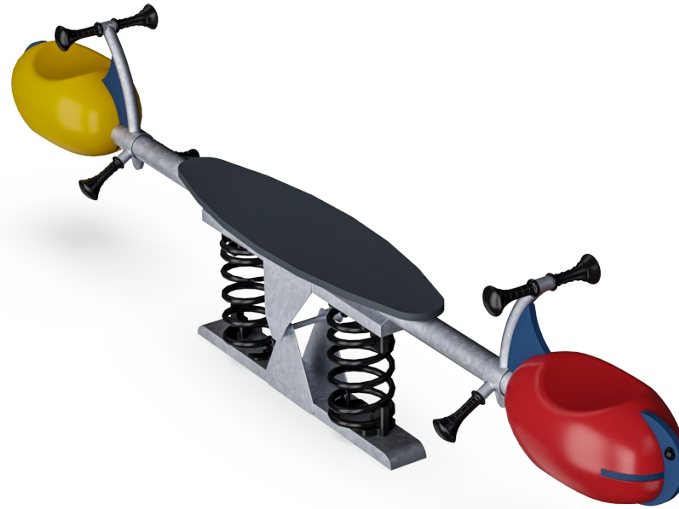

Spring base

Physical: rocking promotes sense of balance and space, both important in for navigating the body confidently in space. **Social-Emotional:** consideration of others when rocking.



Color variation

Cognitive: supports rules understanding and rules games: children will find reasons for choosing the one or the other color.



Wacky body

Physical: hollow seat and sturdy foot and hand support allows for intensity in riding, training arm and leg muscles as well as the senses of space and balance.



Center platform

Physical: supports agility, balance and coordination when standing, using leg and core muscles, building bone density when jumping. Also facilitating sitting. **Social-Emotional:** teamwork and socializing when rocking together.

Hopper

ELE400022



KOMPAN Springs are made of high quality spring steel according to EN10270. The springs are cleaned by phosphating before they are painted with an epoxy primer and a polyester powder coating as top finish. The springs are fixed by unique anti pinch fittings for maximum safety and long lifetime.



Handles and footrests are made with a moulded PP insert and an outer layer of soft TPV rubber. The handles and footrests are attached to the pipe with a galvanised steel inlay to ensure strength and durability.



The middle plate is made of HPL with a thickness of 17.8mm. It has a very high wearing strength and a unique KOMPAN non skid surface texture.



The steel surfaces are hot dip galvanised inside and outside with lead free zinc. The galvanisation has excellent corrosion resistance in outside environments and requires low maintenance.



The seat is made with recycable PE from 33% post consumer materials and moulded in one piece with a minimum 5mm wall thickness. PE has high impact resistance across a wide temperature span which ensures vandal resistance in all locations.



KOMPAN GreenLine versions are designed with ultimate environmentally friendly materials with lowest possible CO2e emission factor such as EcoCore™ panels of +95% post consumer recycled ocean waste.

Item no. ELE400022-01	
Installation Information	
Max. fall height	100 cm
Safety surfacing area	25.8 m ²
Total installation time	3.9
Excavation volume	0.50 m ³
Concrete volume	0.00 m ³
Footing depth (standard)	45 cm
Shipment weight	191 kg
Anchoring options	In-ground ✓ Surface ✓
Warranty Information	
Hollow PE parts	10 years
HPL platform	15 years
Spare parts guaranteed	10 years
Springs	5 years
Stainless steel components	Lifetime

Elevated activities 0	Accessible elevated activities	Accessible ground level activities	Accessible ground level play types
Present	0	1	1
Required	0	1	1



Sustainability Data

ELE400022

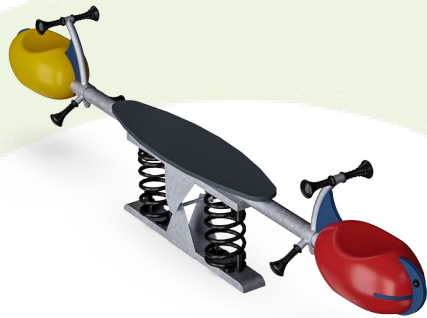

Cradle to Gate A1-A3	Total CO ₂ emission	CO ₂ e/kg	Recycled materials
	kg CO ₂ e	kg CO ₂ e/kg	%
ELE400022-01	276.74	2.52	38.14

The overall framework applied for these factors is the Environmental Product Declaration (EPD), which quantifies "environmental information on the life cycle of a product and enable comparisons between products fulfilling the same function" (ISO, 2006). This follows the structure and applies a Life-Cycle Assessment approach to the entire Product stage from raw material through manufacturing (A1-A3))

Kompan A/S
C.F. Tietgens Boulevard 32C
DK-5220 Odense SØ
Denmark



Verification of CO₂ calculation of: Freestanding play equipment



Data version no. 2023-10-05

The CO₂ calculation and data are in compliance with the principles of a carbon footprint impact according to the GHG protocol (Greenhouse Gas Protocol), Scope 3, cradle to gate related to all individual components in the product category: "Freestanding play equipment" represented by item no.: GXY916012-3417.

(Scope 3 emissions include emission sources in the upstream and downstream value chain).

Date: 30. October 2023 | Valid until: 30. October 2025

Verified by:

Julie Marie Vejsgaard Larsen, LCA & EPD Consultant

Verification based on report: Validation of CO₂ calculation of 9 categories of Kompan product line, version 1.0, prepared by: Bureau Veritas HSE, Denmark: Julie M. V. Larsen.

Publication date: 30. October 2023

By Bureau Veritas HSE
www.bureauveritas.dk
+45 7731 1000



Hopper

ELE400022

* Max fall height | ** Total height | *** Safety surfacing area

* Max fall height | ** Total height

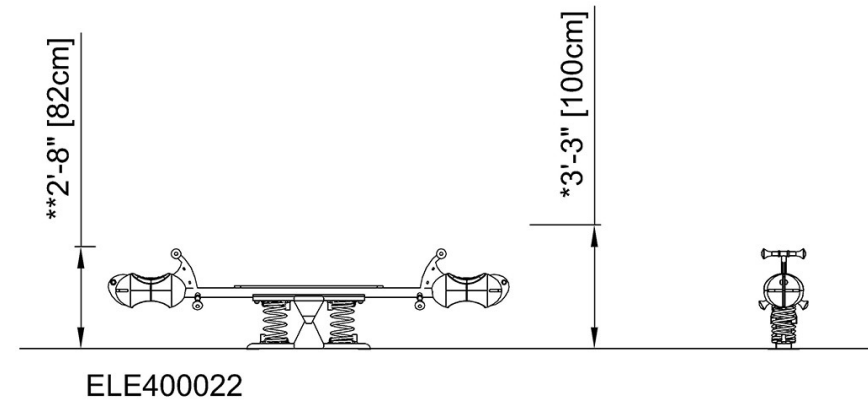
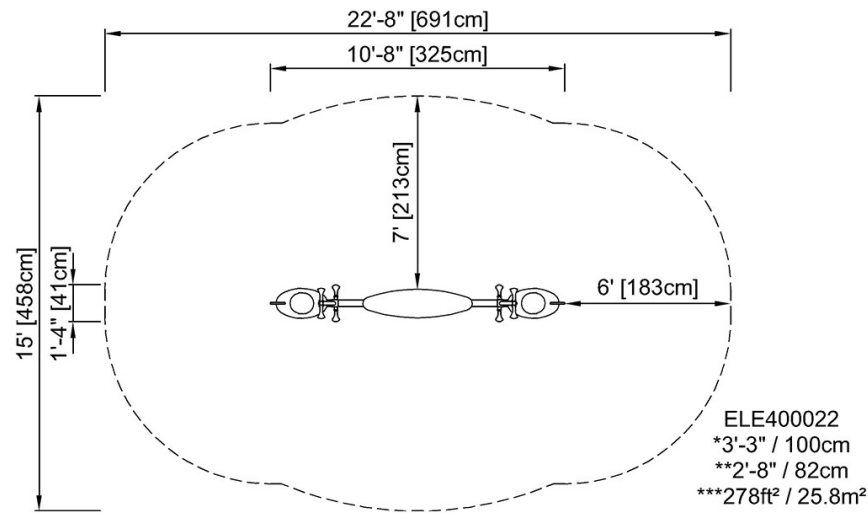

[Click to see TOP VIEW](#)

[Click to see SIDE VIEW](#)