

Step, 60cm PU Steel

FAZ30301

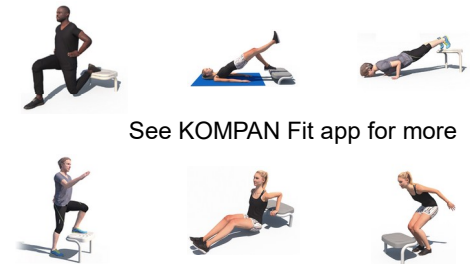

Item no. FAZ30301-0900	
General Product Information	
Dimensions LxWxH	61x41x56 cm
Age group	13+
Play capacity (users)	1
Colour options	



See KOMPAN Fit app for more



So many exercises can be done with The Step, it is one of the most simple yet highly versatile training tools. From simple step ups to plyometric jumps, with regular sessions it will provide both cardiovascular and muscular endurance. The Step incorporates upper and lower body movements which will improve balance and agility and constant push ups will increase leg strength.

Step, 60cm PU Steel

FAZ30301



The support frame is $\varnothing 48.3 \times 4$ mm, carbon steel, with a hot-dip galvanised surface according to ISO1461, and a powder coating corrosion class C3 according to ISO12944-2. Lead content for surfaces is below 90ppm.

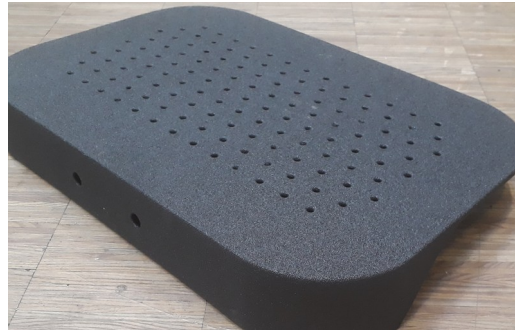

The polyurea coating, used on all grips, is highly durable against wear and tear, offers isolation and simultaneously gives users an outstanding grip during their workout.



A 5 mm hot-dip galvanised carbon steel plate must be moulded inside the SBR to offer optimal stability and optimise the mounting of the step to the frame.

Item no. FAZ30301-0900

Installation Information

Max. fall height	56 cm
Safety surfacing area	10.4 m ²
Total installation time	1.7
Excavation volume	0.13 m ³
Concrete volume	0.07 m ³
Footing depth (standard)	90 cm
Shipment weight	80 kg
Anchoring options	In-ground ✓ Surface ✓

Warranty Information

Frame	10 years
Painted Steel Panels	10 years
Spare Parts Guarantee	10 years



All of KOMPAN's fitness products are compliant with AS 4685:2021, ASTM F3101 & EN16630 Outdoor Fitness Standards. Load tests are performed to the specified load of 78kg per user. A product intended for one user is loaded with 420kg.



Sustainability Data

FAZ30301



Cradle to Gate A1-A3	Total CO ₂ emission	CO ₂ e/kg	Recycled materials
	kg CO ₂ e	kg CO ₂ e/kg	%
FAZ30301-0900	112.25	2.59	49.85

The overall framework applied for these factors is the Environmental Product Declaration (EPD), which quantifies "environmental information on the life cycle of a product and enable comparisons between products fulfilling the same function" (ISO, 2006). This follows the structure and applies a Life-Cycle Assessment approach to the entire Product stage from raw material through manufacturing (A1-A3))

Kompan A/S
 C.F. Tietgens Boulevard 32C
 DK-5220 Odense SØ
 Denmark



Verification of CO₂ calculation of: Fitness



Data version no. 2023-10-05

The CO₂ calculation and data are in compliance with the principles of a carbon footprint impact according to the GHG protocol (Greenhouse Gas Protocol), Scope 3, cradle to gate related to all individual components in the product category: "Fitness" represented by item no.: FAZ10100-0900.

(Scope 3 emissions include emission sources in the upstream and downstream value chain).

Date: 30. October 2023 | Valid until: 30. October 2025

Verified by:

Julie Marie Vejsgaard Larsen, LCA & EPD Consultant

Verification based on report: Validation of CO₂ calculation of 9 categories of Kompan product line, version 1.0, prepared by: Bureau Veritas HSE, Denmark: Julie M. V. Larsen.

Publication date: 30. October 2023

By Bureau Veritas HSE
 www.bureauveritas.dk
 +45 7731 1000



Step, 60cm PU Steel

FAZ30301

* Max fall height | ** Total height | *** Safety surfacing area

* Max fall height | ** Total height

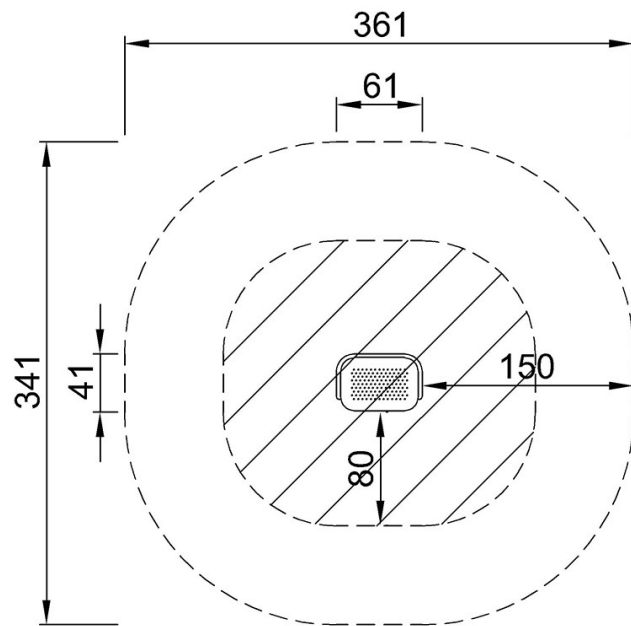

FAZ30301
*56cm
**56cm
***10.4m²



FAZ30301

[Click to see TOP VIEW](#)

[Click to see SIDE VIEW](#)