

# Multi Deck Playhouse with Roof

PCM002421

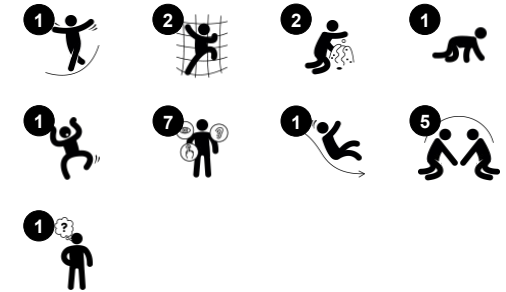

Item no. PCM002421-0605	
General Product Information	
Dimensions LxWxH	224x296x214 cm
Age group	1+
Play capacity (users)	13
Color options	



The multi deck playhouse is an ultimate play attraction for developing toddlers. The many levels and sections stimulate exploration and provide encourage physical play. Children love crawling through the tunnel, this activity trains cross-coordination, a fundamental skill for later reading skills. The playhouse also has a slide which stimulates the sense of balance,

important for mastering any physical activity. The Peek-a-Boo panel has curtains that can be drawn from both sides, inspiring social play and peek-a-boo, developing the understanding of object permanence, that things don't cease to exist because they disappear. The desk has a conveyor belt of small wheels providing a sensory input, stimulating cross modal

perception, important for reading.



Data is subject to change without prior notice.

# Multi Deck Playhouse with Roof

PCM002421



## Tunnel

**Physical:** the children crawl through the tunnel, developing motor skills such as cross-body coordination and proprioception. **Social-Emotional:** turn-taking when passing each other.



## Slide

**Physical:** sliding develops spatial awareness and a sense of balance. Furthermore, the core muscles are trained when sitting upright going down. **Social-Emotional:** empathy stimulated by turn-taking. **Cognitive:** young children develop their understanding of space, speed and distances when sliding down quickly.



## Desk with conveyor belt

**Physical:** tactile stimulation from running hands over rolling spheres on conveyor belt. **Social-Emotional:** sharing and cooperation from both sides create a social scenario that supports communication and cooperation. **Cognitive:** supports dramatic play scenarios, trains cause and effect understanding.



## Balcony

**Social-Emotional:** the balcony invites meetings and interaction with people on ground level. **Cognitive:** invites dramatic play and performance, which stimulates language development.

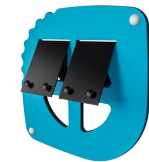

## Window with curtains

**Physical:** tactile stimulation supports sensory skills, when children explore characteristics of the materials. **Social-Emotional:** social interaction between inside and outside, supporting turn-taking and cooperation. **Cognitive:** understanding object permanence when playing, e.g. peek-a-boo. Dramatic play support, encouraging language skills. **Creative:** leaving a mark, deciding how to place curtains.

# Multi Deck Playhouse with Roof

PCM002421

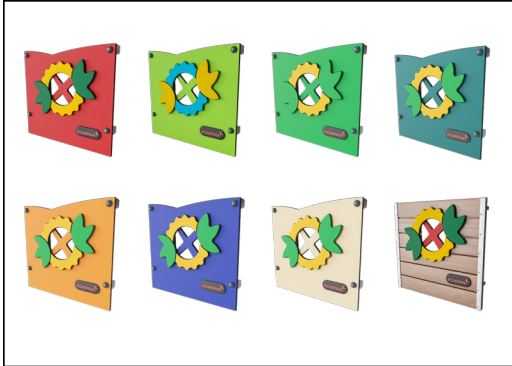

Panels of 19mm EcoCore™. EcoCore™ is a highly durable, eco friendly material, which is not only recyclable after use, but is also produced from +95% recycled post consumer material from food packing waste. Wooden panels of impregnated and brown painted pine wood with vertical steel profiles.



Main posts with hot dip galvanized steel footing are available in different materials: Pressure impregnated pine wood posts. Pre-galvanized inside and outside with powder coated top finish steel posts. Lead free aluminum with color anodized top finish. Greenline TexMade posts of 95% post-consumer recycled PE and textile waste.

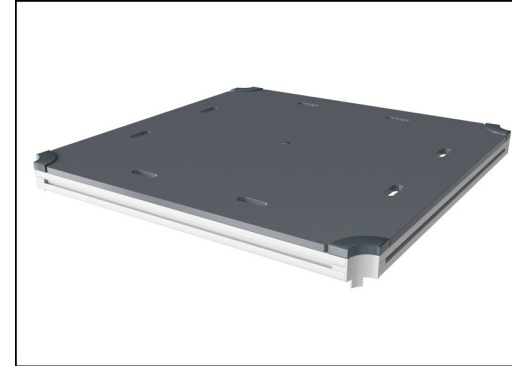

All decks are supported by unique designed low-carbon aluminum profiles with multiple attachment options. The grey colored molded decks are made of 75% post-consumer waste PP material with a non-skid pattern and texture surface.

Item no. PCM002421-0605	
Installation Information	
Max. fall height	100 cm
Safety surfacing area	21.9 m <sup>2</sup>
Total installation time	16.3
Excavation volume	0.32 m <sup>3</sup>
Concrete volume	0.00 m <sup>3</sup>
Footing depth (standard)	60 cm
Shipment weight	450 kg
Anchoring options	In-ground ✓ Surface ✓
Warranty Information	
EcoCore HDPE	Lifetime
Post	10 years
PP Decks	10 years
Spare parts guaranteed	10 years



Coloured steel components have a base of hot dip galvanisation and a powder coated top finish. This provides an ultimate corrosion resistance in all climates around the world.

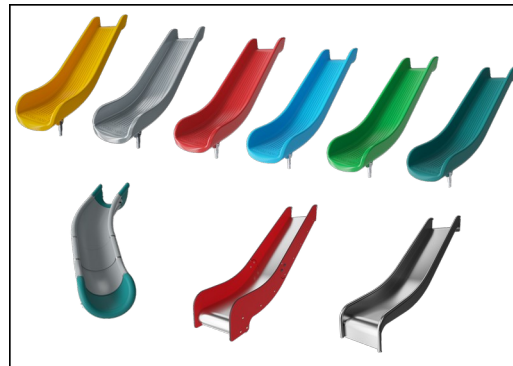

The slides can be chosen in six different colors and three materials: Straight or curved one-piece molded PE slides, made from 33% recycled post-consumer materials in different colours. Combined EcoCore™ sides and stainless-steel. Full stainless steel in one piece design for more vandalism proof solutions.



KOMPAN GreenLine versions are designed with ultimate environmentally friendly materials with lowest possible CO2e emission factor such as EcoCore™ panels of +95% post consumer recycled ocean waste.



# Sustainability Data

PCM002421



Cradle to Gate A1-A3	Total CO <sub>2</sub> emission	CO <sub>2</sub> e/kg	Recycled materials
	kg CO <sub>2</sub> e	kg CO <sub>2</sub> e/kg	%
<b>PCM002421-0651</b>	471.10	1.30	74.27
<b>PCM002421-0605</b>	602.72	1.89	64.39

The overall framework applied for these factors is the Environmental Product Declaration (EPD), which quantifies "environmental information on the life cycle of a product and enable comparisons between products fulfilling the same function" (ISO, 2006). This follows the structure and applies a Life-Cycle Assessment approach to the entire Product stage from raw material through manufacturing (A1-A3))

**Kompan A/S**  
 C.F. Tietgens Boulevard 32C  
 DK-5220 Odense SØ  
 Denmark



## Verification of CO<sub>2</sub> calculation of: Play systems



Data version no. 2023-10-05

The CO<sub>2</sub> calculation and data are in compliance with the principles of a carbon footprint impact according to the GHG protocol (Greenhouse Gas Protocol), Scope 3, cradle to gate related to all individual components in the product category: "Play systems" represented by item no.: PCM200321-0950.

(Scope 3 emissions include emission sources in the upstream and downstream value chain).

**Date: 30. October 2023 | Valid until: 30. October 2025**

Verified by:

Julie Marie Vejsgaard Larsen, LCA & EPD Consultant

Verification based on report: Validation of CO<sub>2</sub> calculation of 9 categories of Kompan product line, version 1.0, prepared by: Bureau Veritas HSE, Denmark: Julie M. V. Larsen.

**Publication date: 30. October 2023**

By Bureau Veritas HSE  
 www.bureauveritas.dk  
 +45 7731 1000



# Multi Deck Playhouse with Roof

PCM002421

\* Max fall height | \*\* Total height | \*\*\* Safety surfacing area

\* Max fall height | \*\* Total height

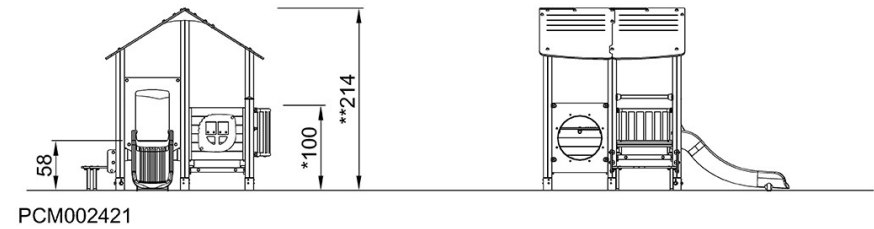
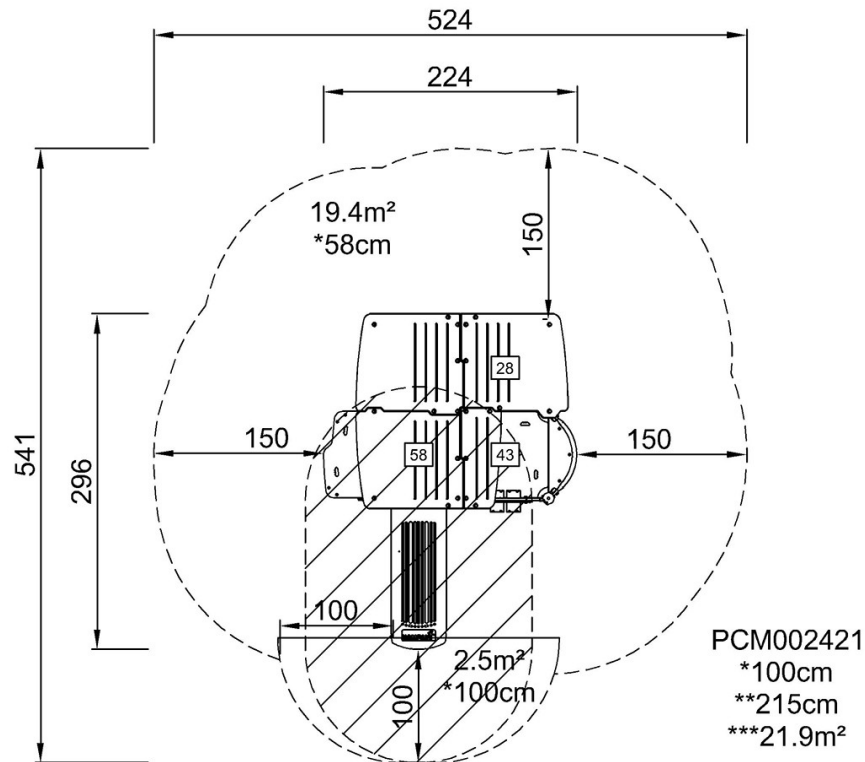

[Click to see TOP VIEW](#)

[Click to see SIDE VIEW](#)