

Double Cableway for Sloping Ground

NRO880



Item no. NRO880-1001

General Product Information

Dimensions LxWxH	3321x512x298 cm
Age group	4+
Play capacity (users)	2
Colour options	 



What child doesn't like flying through the air on a super long cableway? And with this double cableway, children and adults can race their friends and family zipping down the line! This cableway can also be adjusted to have a ride between 19m and 25m long, and is designed to go on an existing slope. Combine the thrill of the ride with the look and feel of natural

Robinia timber, which provides an organic structure that can either blend into or stand out from your surrounds. Children can touch and feel the timber while playing, observing how nature inspiration interacts with the built environment

Double Cableway for Sloping Ground

NRO880



PUR covered rope

Physical: firm grip when spinning and hanging from arms. Arm muscles developed when held tight.



Long line

Physical: the lengthy glide through the air adds to the thrill and trains spatial awareness, trunk stability and upper-body muscles. All this helps support the child's physical self esteem, making e.g. positive risk taking easier.



Dino seat

Physical: the three divisions and chains of the seat provide efficient handholds for both standing and seated swinging. **Social-Emotional:** the possibility of children swinging together, legs hanging down, trains cooperation, sequencing and turn-taking when swinging.

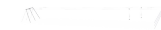

Double zipline

Social-Emotional: the possibility to glide with a companion or have friendly competitions supports turn taking and cooperation skills. **Cognitive:** the speed may differ between the two zip lines. Figuring out the reason behind this (weight, speed, force etc.) trains logical thinking.

Double Cableway for Sloping Ground

NRO880



All organic Robinia products by KOMPAN are made of Robinia wood which is sourced from sustainable plantation farms. On request it can be supplied as FSC® Certified (FSC® C004450).



The steel surfaces are hot-dip galvanised inside and outside with lead-free zinc. The galvanisation has excellent corrosion resistance in outside environments and requires low maintenance.



The specially designed seat is made from a stainless-steel insert covered with a soft layer of PUR rubber. The seat is impact tested to comply with global playground standards, and the rope has an ergonomic handhold of a 100cm long moulded on PUR rubber handle.

Item no. NRO880-1001

Installation Information

Max. fall height	100 cm
Safety surfacing area	182.1 m ²
Total installation time	14.1
Excavation volume	9.37 m ³
Concrete volume	3.84 m ³
Footing depth (standard)	100 cm
Shipment weight	897 kg
Anchoring options	In-ground ✓

Warranty Information

Cable	10 years
Movable Parts	2 years
PUR Components	10 years
Robinia Wood	15 years
Spare Parts Guarantee	10 years

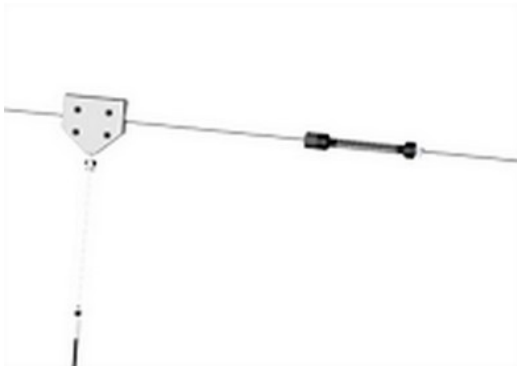

The high-quality steel cable with a diameter of 12mm is designed for heavy usage of the cableway for many years. The starting point is indicated by a knob. At the stop point, there is a uniquely designed spring device, ensuring a softer stop of the puller.

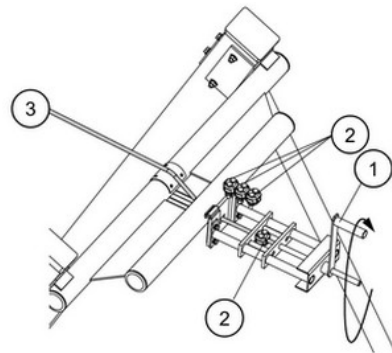

The steel cable three is tensioned by a specially designed device. By turning the handle, the steel cable can be tensioned safely. After tensioning the cable is locked by three clamps two. The tensioning device can also be used for adjustment during annual inspections.

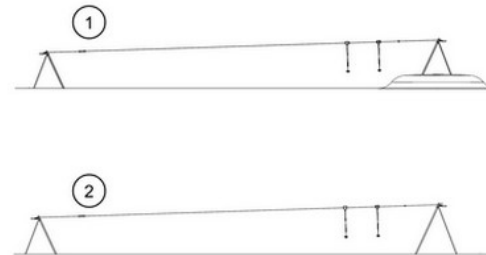

KOMPAN cableways are available for flat or natural sloped surroundings and for surface or in-ground installation. Further, the cableways can be supplied with one or two cables for children to ride together in friendly competition.



Sustainability Data

NRO880

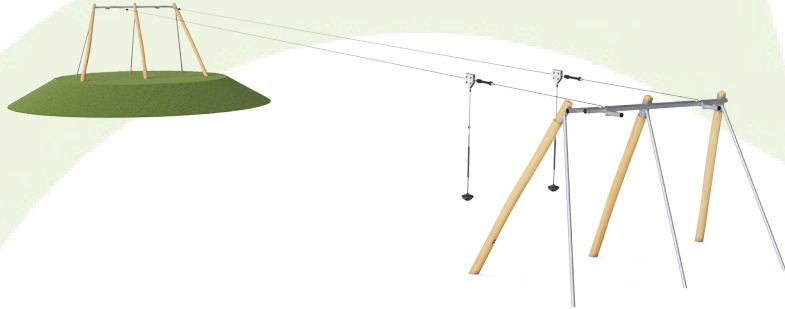

Cradle to Gate A1-A3	Total CO ₂ emission	CO ₂ e/kg	Recycled materials
	kg CO ₂ e	kg CO ₂ e/kg	%
NRO880-1001	1,092.60	1.39	25.28

The overall framework applied for these factors is the Environmental Product Declaration (EPD), which quantifies "environmental information on the life cycle of a product and enable comparisons between products fulfilling the same function" (ISO, 2006). This follows the structure and applies a Life-Cycle Assessment approach to the entire Product stage from raw material through manufacturing (A1-A3))

Kompan A/S
 C.F. Tietgens Boulevard 32C
 DK-5220 Odense SØ
 Denmark



Verification of CO₂ calculation of: Nature play



Data version no. 2023-10-05

The CO₂ calculation and data are in compliance with the principles of a carbon footprint impact according to the GHG protocol (Greenhouse Gas Protocol), Scope 3, cradle to gate related to all individual components in the product category: "Nature play" represented by item no.: NRO409-0621.

(Scope 3 emissions include emission sources in the upstream and downstream value chain).

Date: 30. October 2023 | Valid until: 30. October 2025

Verified by:

Julie Marie Vejsgaard Larsen, LCA & EPD Consultant

Verification based on report: Validation of CO₂ calculation of 9 categories of Kompan product line, version 1.0, prepared by: Bureau Veritas HSE, Denmark: Julie M. V. Larsen.

Publication date: 30. October 2023

By Bureau Veritas HSE
 www.bureauveritas.dk
 +45 7731 1000



Double Cableway for Sloping Ground

NRO880

* Max fall height | ** Total height | *** Safety surfacing area

* Max fall height | ** Total height

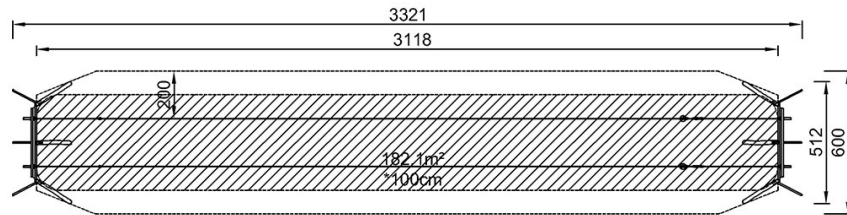

NRO880
*100cm
**298cm
***182.1m²

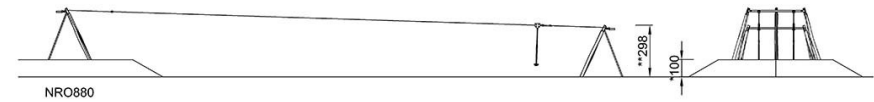

[Click to see TOP VIEW](#)

[Click to see SIDE VIEW](#)