

# Fitness Jumper Wobble

FSW234

**KOMPAN**  
Let's play

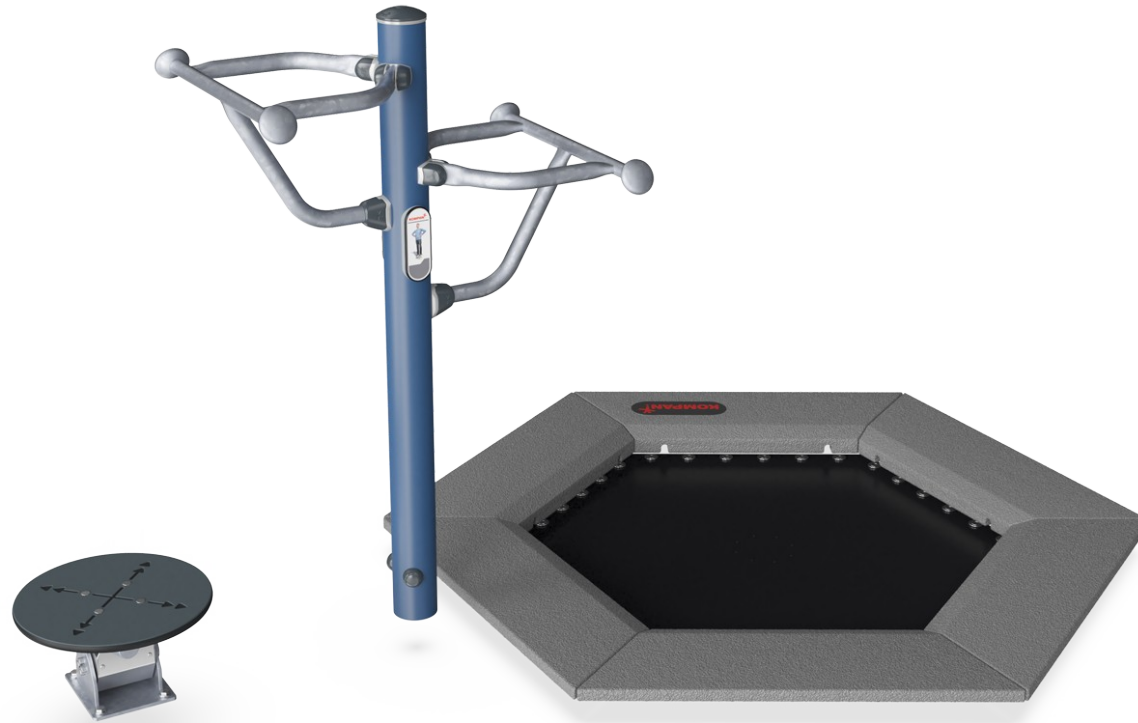

Item no. FSW23400-0902

## General Product Information

Dimensions LxWxH	192x272x140 cm
Age group	13+
Play capacity (users)	2
Color options	



See KOMPAN Fit app for more

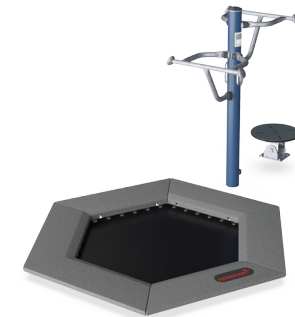

The fitness jumper is designed to be fun, fun, fun - and of course effective for everybody. When exercising on a KOMPAN Fitness Jumper, you get an intense cardiovascular workout, you train your balance and improve your bone density. The Fitness Jumper challenges both the experienced fitness jumper athlete and the average fitness enthusiast.

The handlebars offer support for beginners and adds the possibility to do high intensity power rounds with extra high jumps. By sharing the same post with the Wobble we have created a workout station which is great for improving ankle and knee stability.

# Fitness Jumper Wobble

FSW234

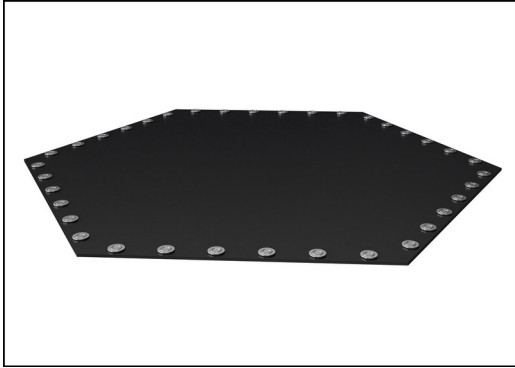

The jumping membranes are made of 6,0mm thick EP Ethylene-Propylene conveyor belt with polyester polyamide fabric carcass. Spring fixations are reinforced with steel bushings and washers on both sides. The membrane is ozone resistant and equipped with 8 center placed water drain holes.



All 36 springs are made of stainless steel to ensure durability and excellent corrosion resistance. The steel wire is 3,2 mm thick and the last five windings are cone shaped to ensure long lifetime of the jumper.

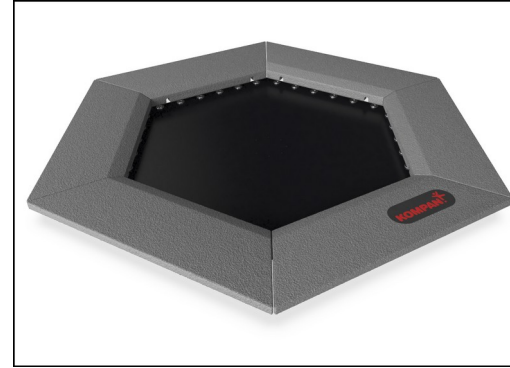

The tiles are molded in grey granulated recycled rubber (SBR/NR), and the KOMPAN logo is made of EPDM Ethylene Propylene Diene Monomer. Inside each of the rubber tiles there is a 3 mm hot dip galvanized steel plate.

Item no. FSW23400-0902

## Installation Information

Max. fall height	100 cm
Safety surfacing area	17.5 m <sup>2</sup>
Total installation time	5.6
Excavation volume	1.24 m <sup>3</sup>
Concrete volume	1.06 m <sup>3</sup>
Footing depth (standard)	90 cm
Shipment weight	435 kg
Anchoring options	

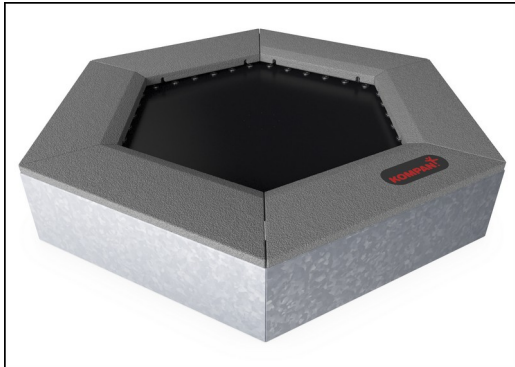

All steel components are manufactured from carbon steel S235 in a thickness of 3 mm. Side panels, support walls for top frame, plates bended with SBR and plates flat for in-situ surfacing are hot dip galvanized.

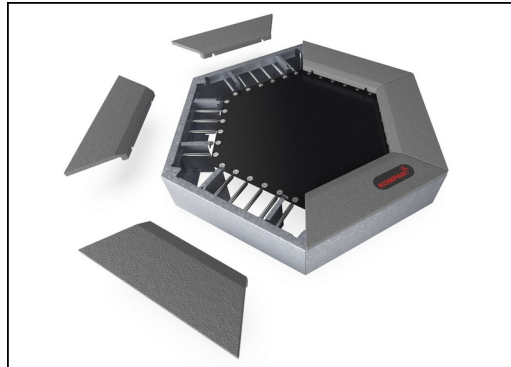

As a unique feature the SBR tiles can be removed for cleaning and service. By loosen six screws the SBR tile can be lifted up to open and gain access to the springs (see instruction on KOMPAN Master).



The double ROSTA element is made of ductile iron and has a hot-dip galvanized finish before painting. The ROSTA element is maintenance-free, with an elastic joint capable of a range of motion up to 250 degrees in any direction. Both wobbles have different stiffness, with a 45% disparity.



# Sustainability Data

FSW234

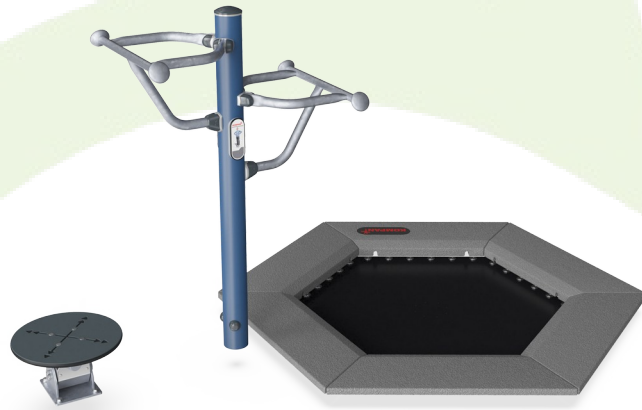

Cradle to Gate A1-A3	Total CO <sub>2</sub> emission	CO <sub>2</sub> e/kg	Recycled materials
	kg CO <sub>2</sub> e	kg CO <sub>2</sub> e/kg	%
<b>FSW23400-0902</b>	557.30	2.33	56.70

The overall framework applied for these factors is the Environmental Product Declaration (EPD), which quantifies "environmental information on the life cycle of a product and enable comparisons between products fulfilling the same function" (ISO, 2006). This follows the structure and applies a Life-Cycle Assessment approach to the entire Product stage from raw material through manufacturing (A1-A3))

**Kompan A/S**  
 C.F. Tietgens Boulevard 32C  
 DK-5220 Odense SØ  
 Denmark



## Verification of CO<sub>2</sub> calculation of: Fitness



Data version no. 2023-10-05

The CO<sub>2</sub> calculation and data are in compliance with the principles of a carbon footprint impact according to the GHG protocol (Greenhouse Gas Protocol), Scope 3, cradle to gate related to all individual components in the product category: "Fitness" represented by item no.: FAZ10100-0900.

(Scope 3 emissions include emission sources in the upstream and downstream value chain).

**Date: 30. October 2023 | Valid until: 30. October 2025**

Verified by:

Julie Marie Vejsgaard Larsen, LCA & EPD Consultant

Verification based on report: Validation of CO<sub>2</sub> calculation of 9 categories of Kompan product line, version 1.0, prepared by: Bureau Veritas HSE, Denmark: Julie M. V. Larsen.

**Publication date: 30. October 2023**

By Bureau Veritas HSE  
 www.bureauveritas.dk  
 +45 7731 1000



# Fitness Jumper Wobble

FSW234

\* Max fall height | \*\* Total height | \*\*\* Safety surfacing area

\* Max fall height | \*\* Total height

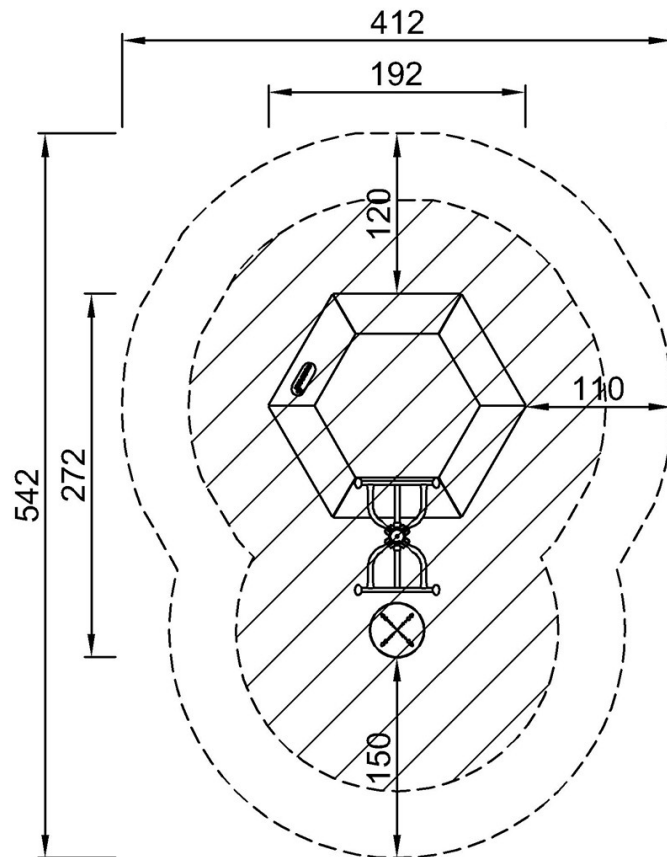

FSW23400  
\*100cm  
\*\*140cm  
\*\*\*17.5m<sup>2</sup>

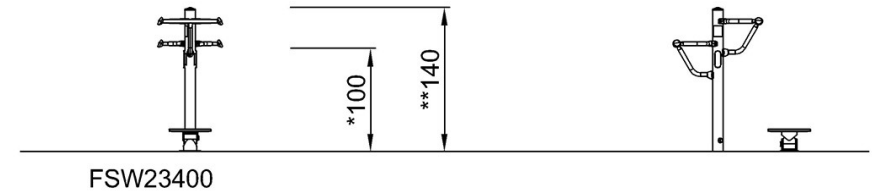

[Click to see TOP VIEW](#)

[Click to see SIDE VIEW](#)